

DESCRIPTION

EV6004-Q-00B Evaluation Board is designed to demonstrate the capability of MP6004's buck function. The MP6004 is a monolithic DC-DC converter which includes 180V power switch and targets isolated or non-isolated 13W PoE application.

MP6004 uses fixed peak current and variable frequency discontinuous conduction mode (DCM) to regulate constant output voltage. Buck mode minimizes the solution size and BOM cost in PoE application if isolation is not needed. High voltage power MOSFET optimizes it for various wide voltage applications.

The MP6004 also features protection including over load and thermal shutdown.

The MP6004 is available in QFN-14 3mmX3mm package.

ELECTRICAL SPECIFICATIONS

Parameter	Symbol	Value	Units
Input voltage	V_{IN}	36-80	V
Output voltage	V_{OUT}	12	V
Output current	I_{OUT}	1	A
Programmed I_{PEAK}	I_{PEAK}	2.5	A

FEATURES

- Buck Converter from up to 80V Input
- Integrated 180V Switching Power MOSFET
- Internal 80V V_{CC} Supply Circuit
- Up to 3A Programmable Current Limit
- Discontinuous Conduction Work Mode
- Include OLP and Thermal Protection
- Minimal External Components Count
- Available in QFN-14 3mmx3mm Package

APPLICATIONS

- Security Camera
- VoIP Phones
- WLAN Access Points
- General Flyback and Buck Converter

All MPS parts are lead-free, halogen free, and adhere to the RoHS directive. For MPS green status, please visit MPS website under Quality Assurance. "MPS" and "The Future of Analog IC Technology" are Registered Trademarks of Monolithic Power Systems, Inc.

EV6004-Q-00B EVALUATION BOARD



(L x W x H) (6.35cm x 6.35cm x 1.5cm)

Board Number	MPS IC Number
EV6004-Q-00B	MP6004GQ

Efficiency

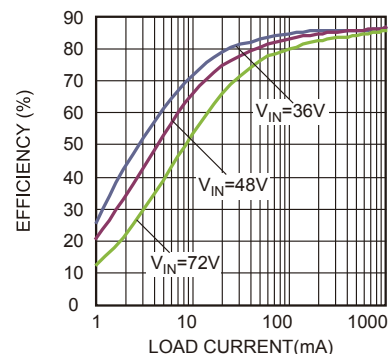

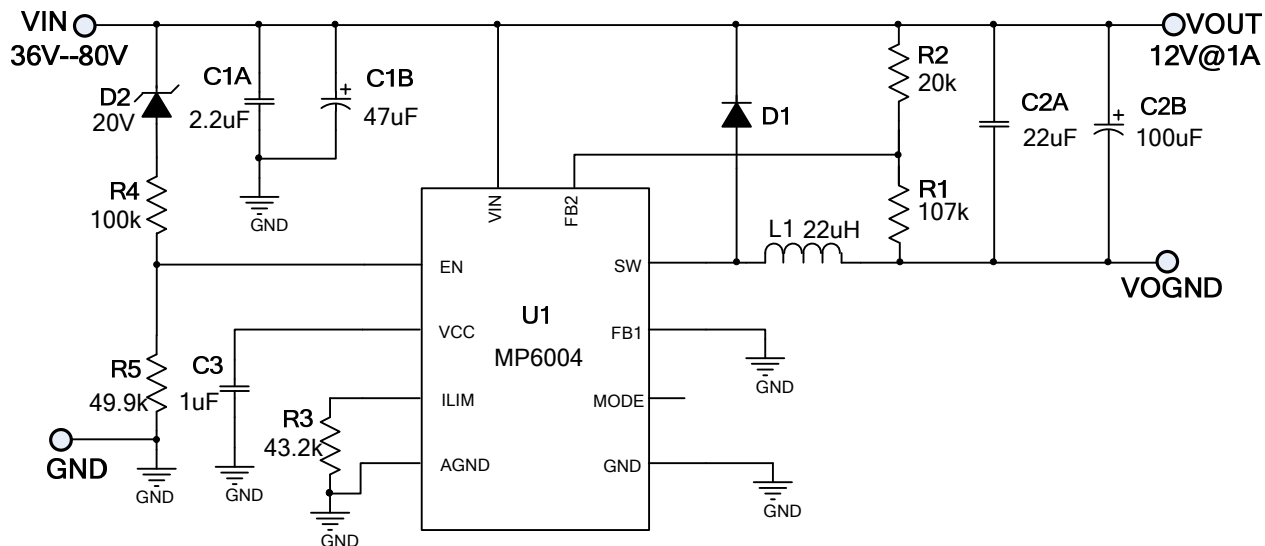
EVALUATION BOARD SCHEMATIC

EV6004-Q-00B BILL OF MATERIALS

Qty	Ref	Value	Description	Package	Manufacturer	Part Number
1	C1A	2.2µF	Ceramic Cap., 100V, X7R	1210	muRata	GRM32ER72A225KA35L
1	C1B	47µF	47µF 100V CD284 E-Cap 10X12.5mm	DIP	JiangHai	47µF/100V
1	C2A	22µF	Ceramic Cap.,25V,X7R	1210	muRata	GRM32ER71E226KE15L
1	C2B	100µF	100µF 25V CD284 E-Cap 6.3X11.5mm	DIP	JiangHai	100uF/25V
1	C3	1µF	Ceramic Cap,10V,X7R	0603	muRata	GRM188R71A105KA61D
1	R1	107k	Film Res,1%	0603	ROYAL	RC0603FR-07107KL
1	R2	20k	Film Res,1%	0603	ROYAL	RC0603FR-0720KL
1	R3	43.2k	Film Res,1%	0603	ROYAL	RC0603FR-0743K2L
1	R4	100k	Film Res,1%	0603	ROYAL	RC0603FR-07100KL
1	R5	49.9k	Film Res,1%	0603	ROYAL	RC0603FR-0749K9L
1	D1	PDS3100	3A 100V SUPER BARRIER RECTIFIER	POWERDI5	Diodes	PDS3100
1	D2	BZT52C20	20V zener	SOD-123	Diodes	WBZT52C20
1	L1	22µH	Isat=3A, DCR=77.6mΩ		TOKO	D104C-#919AS-220M
1	U1	MP6004	DC/DC converter	QFN-14 (3mmX3mm)	MPS	MP6004GQ

EVB TEST RESULTS

$V_{IN}=48V$, $V_{OUT}=12V$, $I_{OUT}=1A$, $T_A=25^\circ C$, unless otherwise noted.

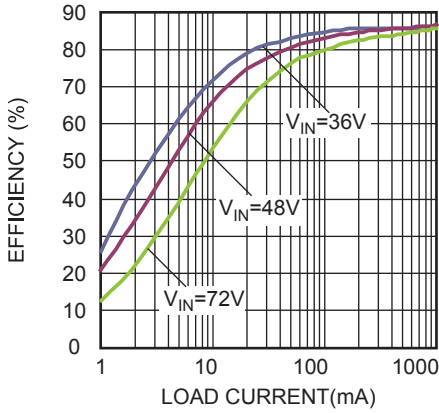
Efficiency



Load Regulation

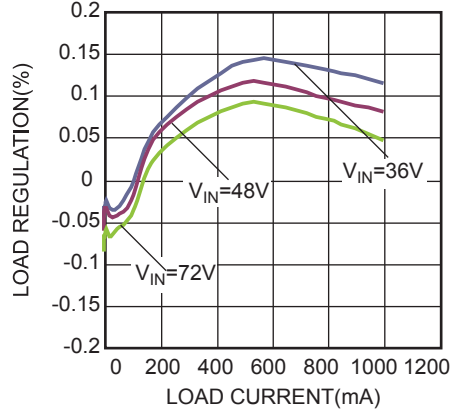

Line Regulation

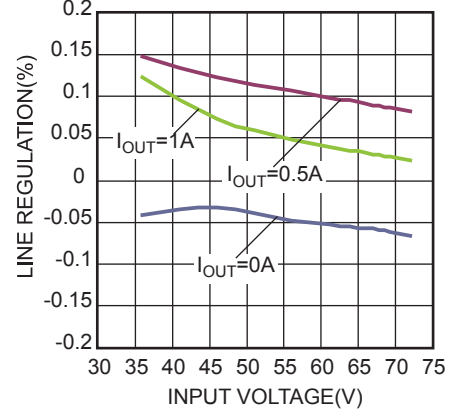

Case Temperature Rising

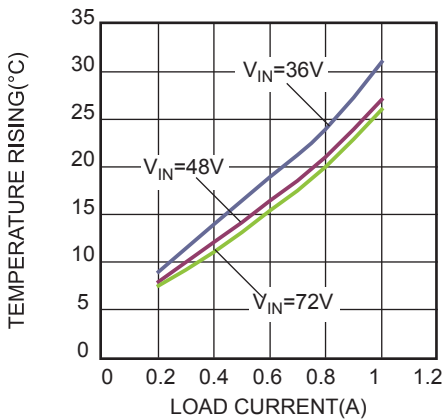

EVB TEST RESULTS (continued)

$V_{IN}=48V$, $V_{OUT}=12V$, $I_{OUT}=1A$, $T_A=25^{\circ}C$, Because V_{IN} and V_{out} have different GND, So the blew waveforms are referred to V_{IN} , unless otherwise noted.

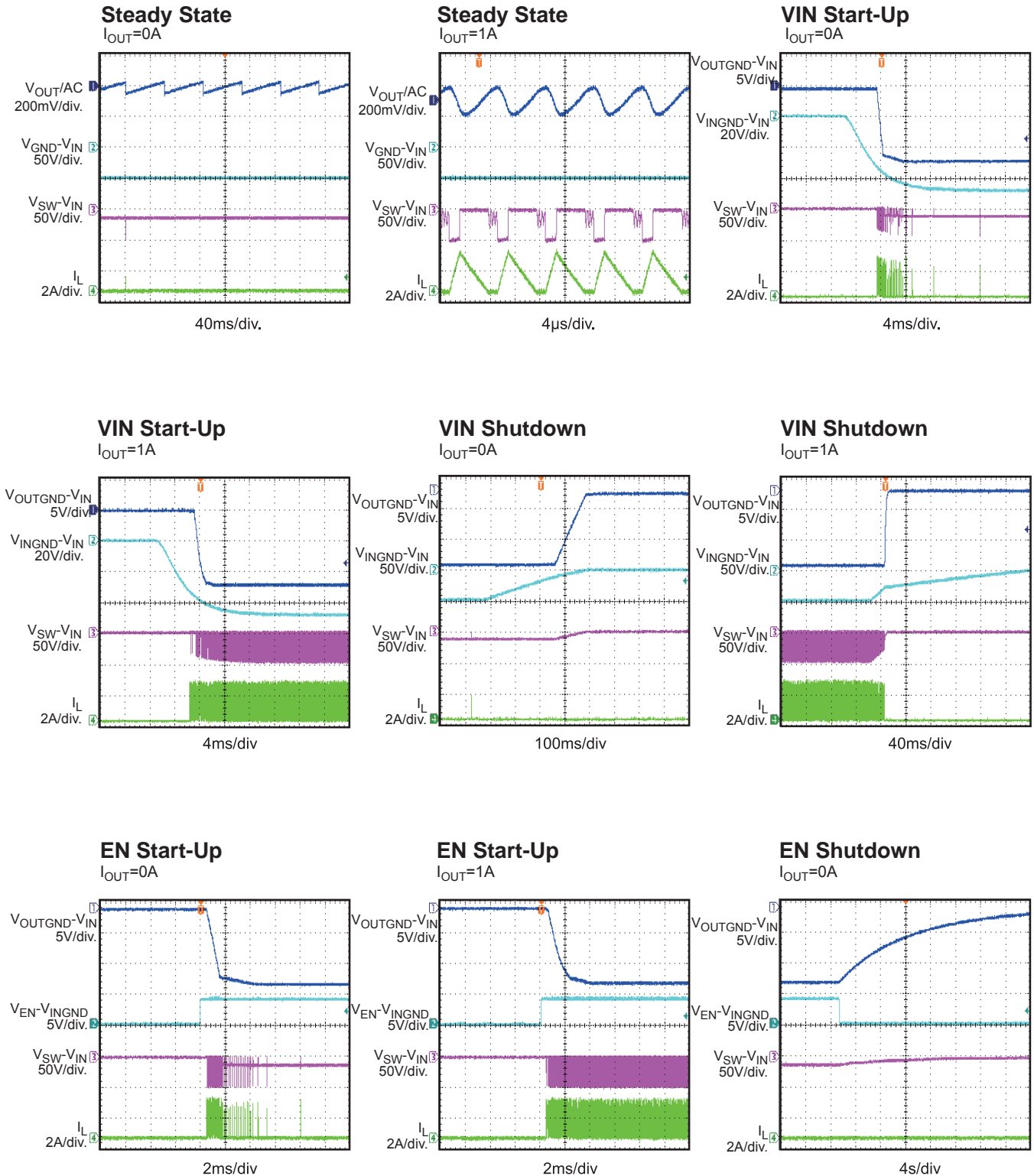

EVB TEST RESULTS (continued)

$V_{IN}=48V$, $V_{OUT}=12V$, $I_{OUT}=1A$, $T_A=25^{\circ}C$, Because V_{IN} and V_{out} have different GND, So the blew waveforms are referred to V_{IN} , unless otherwise noted.

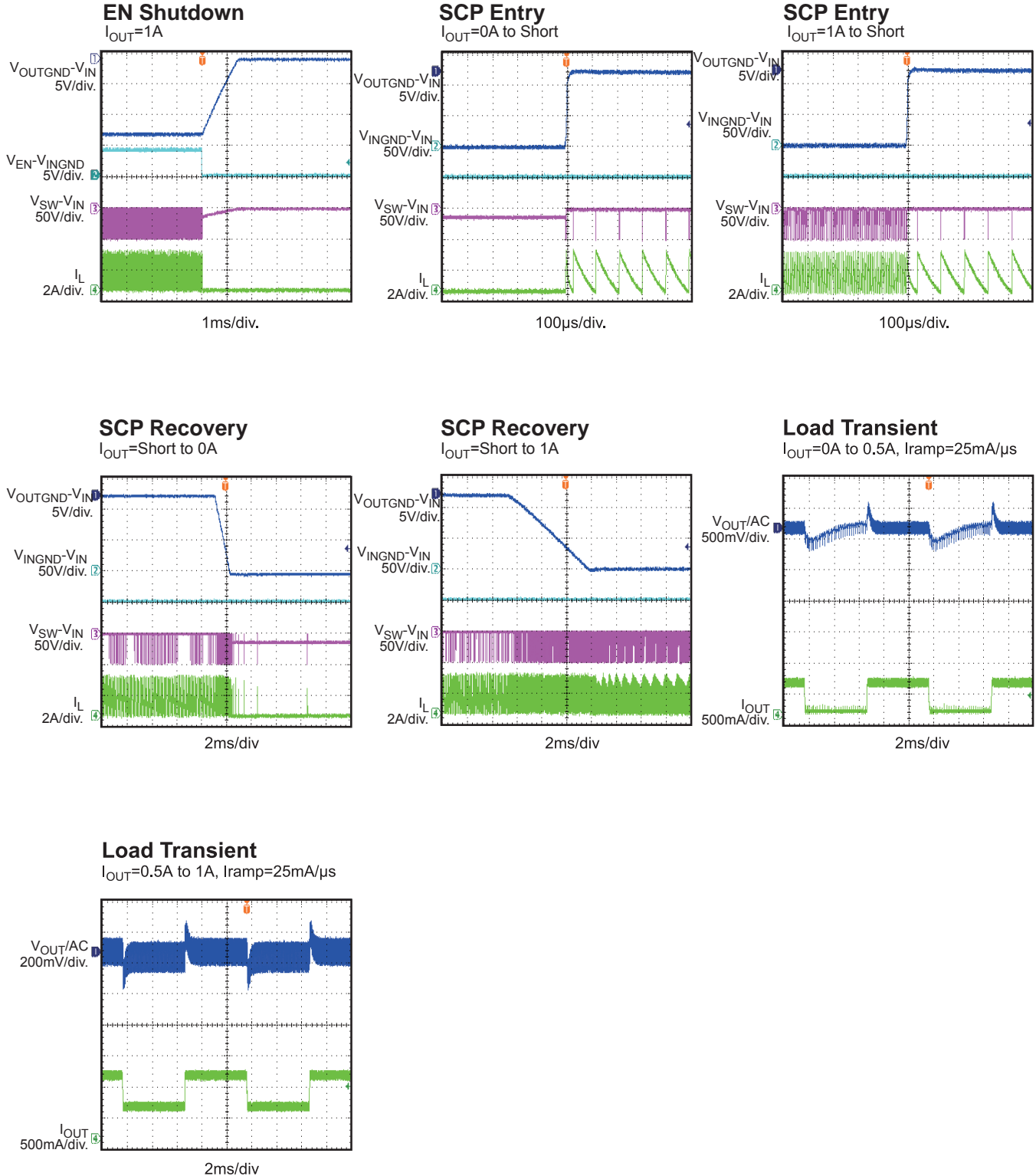

QUICK START GUIDE

The output voltage of this board is set to 12V. The board layout accommodates most commonly used components.

1. Preset Power Supply to $36V \leq V_{IN} \leq 80V$.
2. Turn Power Supply off.
3. Connect Power Supply terminals to:
 - a. Positive (+): VIN
 - b. Negative (-): GND
4. Connect Load to:
 - a. Positive (+): VOUT
 - b. Negative (-): VOGND
5. Turn Power Supply on after making connections.
6. The MP6004 is enabled on the evaluation board once VIN is applied.
7. To use the Enable function, apply a digital input to the EN pin. Drive EN higher than 3.9V to turn on EV6004-Q-00B or less than 1.3V to turn it off.

NOTICE: The information in this document is subject to change without notice. Users should warrant and guarantee that third party Intellectual Property rights are not infringed upon when integrating MPS products into any application. MPS will not assume any legal responsibility for any said applications.