

DESCRIPTION

The EV5403-QB-02A Evaluation Board is designed to demonstrate the capabilities of MPS' MP5403. The MP5403 is a monolithic power management unit containing two high efficiency step-down switching converters and a load switch. The two regulators supply current up to 3.5A and 2.5A separately and the load switch supplies up to 3A load current with extremely low R_{ON} resistance. With the input range up to 6V, the MP5403 is ideal for powering ASIC and SOC for Solid-State Drive or other compact power systems.

The MP5403 requires a minimum number of readily available standard external components and is available in a small QFN20 (2.5mmx3mm) package.

ELECTRICAL SPECIFICATION

Parameter	Symbol	Value	Units
Input Voltage	V_{IN1}/V_{IN2}	2.7 – 6	V
Output Voltage	V_{OUT1}/V_{OUT2}	1.2/1.2	V
Output Current	I_{OUT1}/I_{OUT2}	3.5/2.5	A

FEATURES

- Up to 6V Operating Input Range
- Low IQ: 85µA for Two Switchers Totally
- Two Buck Converters:
 - 3.5A with 55mΩ/20mΩ $R_{DS(ON)}$
 - 2.5A with 65mΩ/22mΩ $R_{DS(ON)}$
 - 1.5MHz Switching Frequency
- One Load Switch with 20mΩ R_{ON}
 - 3A with 20mΩ $R_{DS(ON)}$
 - Soft Start and Output Discharge
 - Over Current Protection
- Input Power Good Indicator with Adjustable Threshold and Delay
- Thermal Shutdown
- Available in a QFN20 (2.5mmx3mm) Package

APPLICATIONS

- Solid-State Drive
- Portable Instruments
- Battery-Powered Devices

All MPS parts are lead-free and adhere to the RoHS directive. For MPS green status, please visit MPS website under Products, Quality Assurance page.

"MPS" and "The Future of Analog IC Technology", are Registered Trademarks of Monolithic Power Systems, Inc.

EV5403-QB-02A EVALUATION BOARD



(L x W x H) 6.5cm x 6.5cm x 1.6cm

Board Number	MPS IC Number
EV5403-QB-02A	MP5403

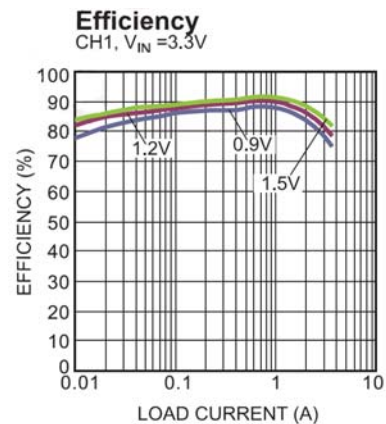

EVALUATION BOARD SCHEMATIC

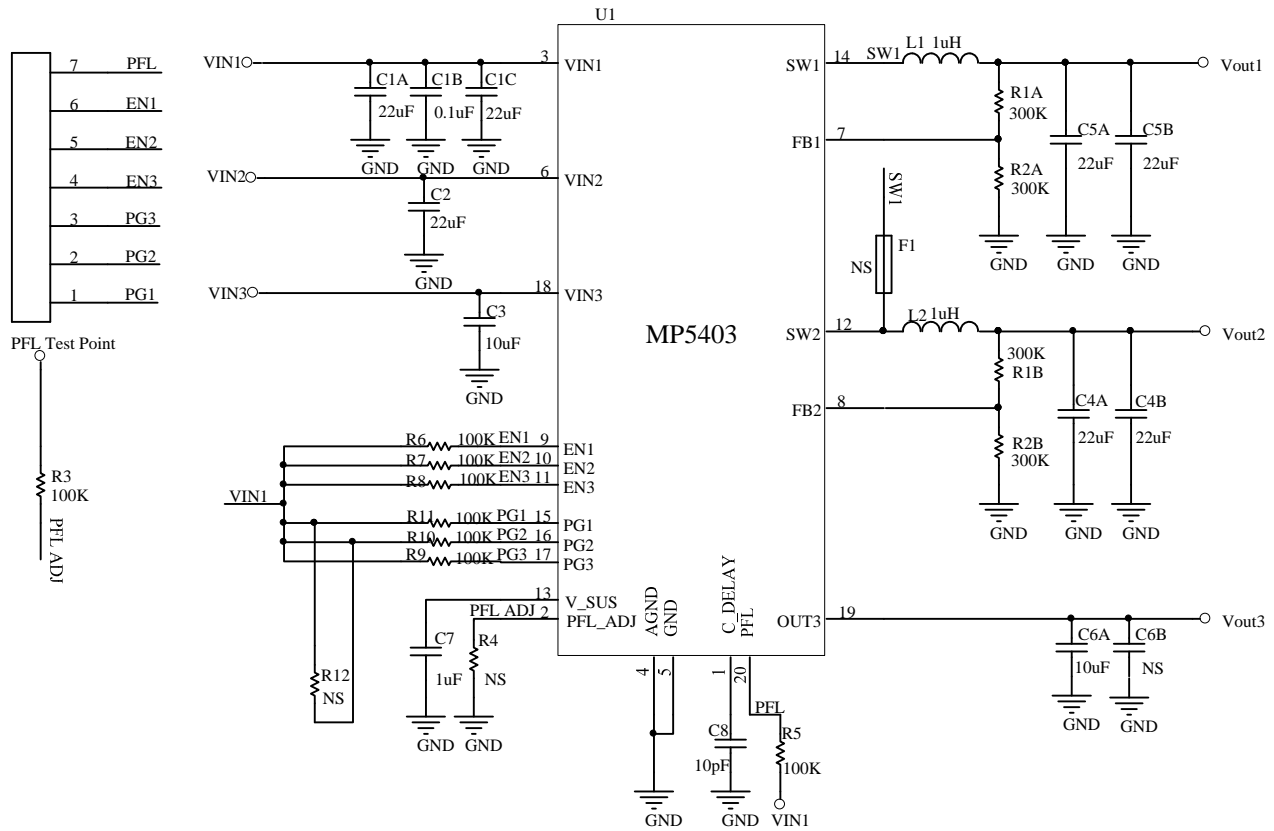

EV5403-QB-02A BILL OF MATERIALS

Qty	Ref	Value	Description	Package	Manufacturer	Part Number
2	L1, L2	1μH	Inductor, ±20%	SMD	Wurth	744 373 240 10
7	C1A, C1C, C2, C4A, C4B, C5A, C5B	22μF	Ceramic Capacitor, 10V, X5R	0805	muRata	GRM21BR61A226ME51L
2	C3, C6A	10μF	Ceramic Capacitor, 10V, X5R	0805	muRata	GRM21BR61A106KE19L
1	C7	1μF	Ceramic Capacitor, 16V, X7R	0603	muRata	GRM21BR71C105KA01L
1	C1B	0.1μF	Ceramic Capacitor, 16V, X7R	0603	muRata	GRM219R71C104KA01D
1	C8	10pF	Ceramic Capacitor, 50V, COG	0603	muRata	GRM1885C1H100JA01D
4	R1A, R1B, R2A, R2B	300kΩ	Film Res, 1%	0603	ROYAL	RL0603FR-07300KL
8	R3, R5, R6, R7, R8, R9, R10, R11	100kΩ	Film Res, 5%	0603	Any	Any
1	U1	MP5403	Dual buck and one load switch PWIC	QFN20	MPS	MP5403
1	CN1		1X7 PINS, 2.54mm		Any	Any

EVB TEST RESULTS

Performance waveforms are tested on the evaluation board.

$V_{IN1} = V_{IN2} = 5V$, $V_{OUT1} = V_{OUT2} = 1.2V$, $L1 = L2 = 1\mu H$, $T_A = 25^\circ C$, unless otherwise noted.

Output Ripple

$I_{OUT1} = I_{OUT2} = 0A$

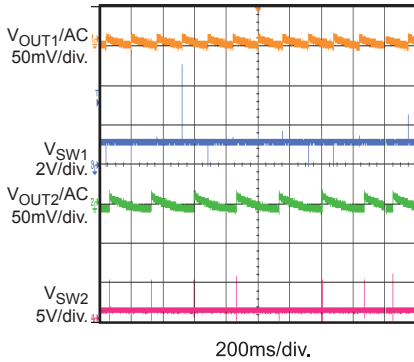

Output Ripple

$I_{OUT1} = 3.5A$, $I_{OUT2} = 2.5A$

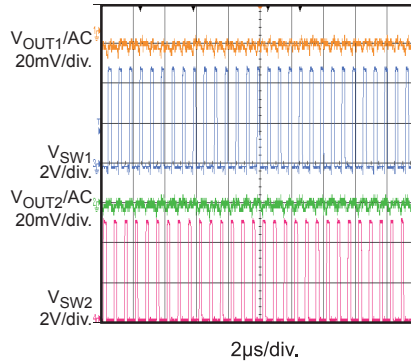

VIN Power Up without Load (CH1)

$I_{OUT1} = 0A$

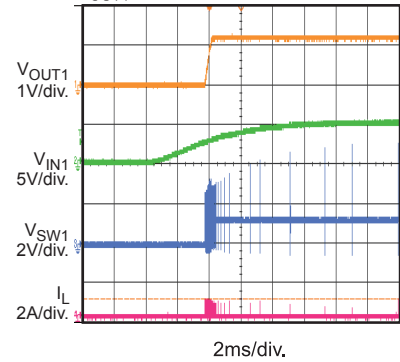

VIN Power Up with 3.5A Load (CH1)

$I_{OUT1} = 3.5A$

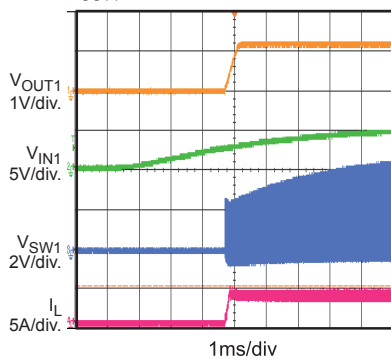

VIN Power Down without Load (CH1)

$I_{OUT1} = 0A$

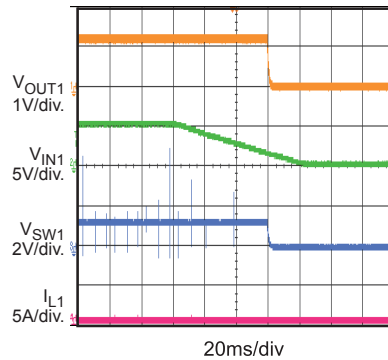

VIN Power Down with 3.5A Load (CH1)

$I_{OUT1} = 3.5A$

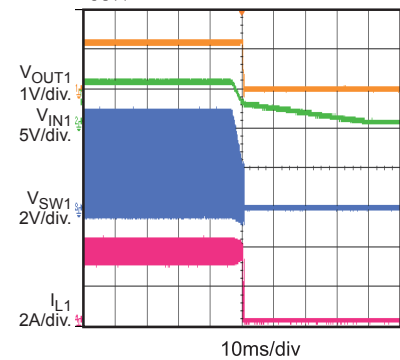

EN On without Load (CH1)

$I_{OUT1} = 0A$

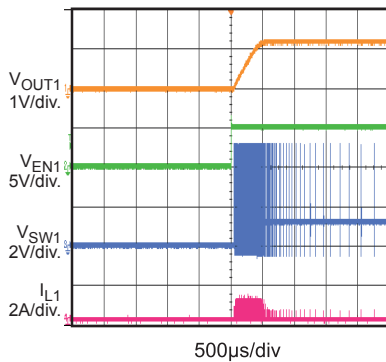

EN On with 3.5A Load (CH1)

$I_{OUT1} = 3.5A$

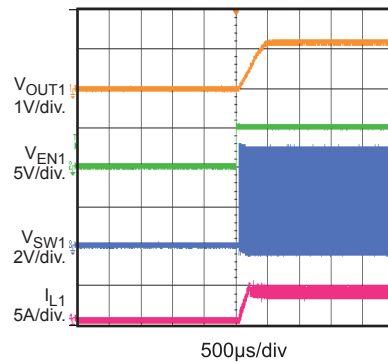

EN Down without Load (CH1)

$I_{OUT1} = 0A$

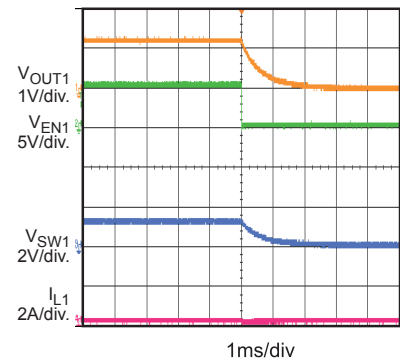

EVB TEST RESULTS (continued)

Performance waveforms are tested on the evaluation board.

$V_{IN1} = V_{IN2} = 5V$, $V_{OUT1} = V_{OUT2} = 1.2V$, $L1 = L2 = 1\mu H$, $T_A = 25^\circ C$, unless otherwise noted.

EN Down with 3.5A Load (CH1)

$V_{IN} = 5V$, $V_{OUT1} = 1.2V$, $I_{OUT1} = 3.5A$

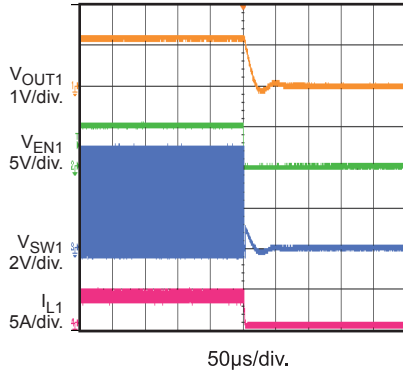

VIN Power On with 2.5A Load (CH2)

$V_{IN} = 5V$, $V_{OUT2} = 1.2V$, $I_{OUT2} = 2.5A$

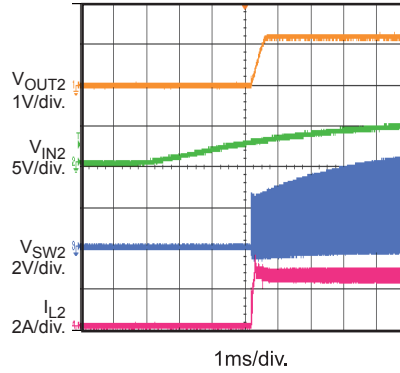

VIN Power Down with 2.5A Load (CH2)

$V_{IN} = 5V$, $V_{OUT2} = 1.2V$, $I_{OUT2} = 2.5A$

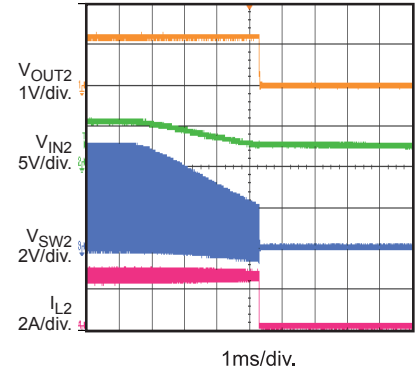

Enable On with 2.5A Load (CH2)

$V_{IN} = 5V$, $V_{OUT2} = 1.2V$, $I_{OUT2} = 2.5A$

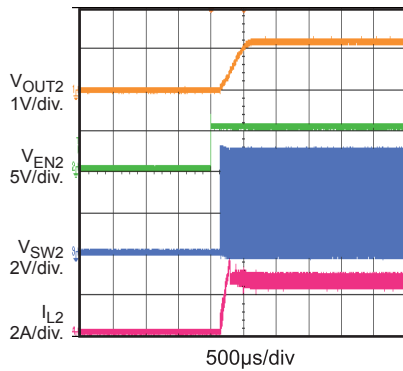

Enable Down with 2.5A Load (CH2)

$V_{IN} = 5V$, $V_{OUT2} = 1.2V$, $I_{OUT2} = 2.5A$

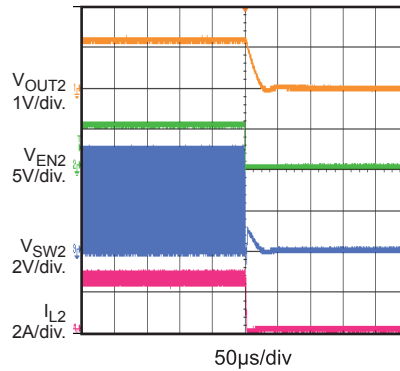

CH1 Transient

$V_{IN} = 5V$, $V_{OUT1} = 1.2V$, 1A Transient to 3.5A, 2.5A/µs Speed

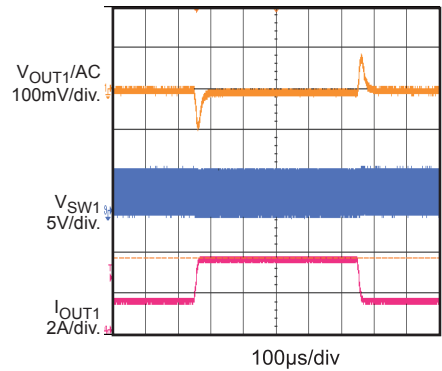

CH2 Transient

$V_{IN} = 5V$, $V_{OUT2} = 1.2V$, 1A Transient to 2.5A, 2.5A/µs Speed

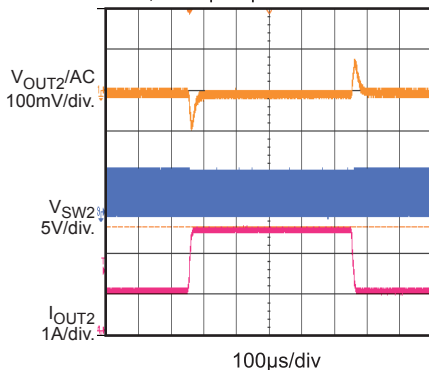

CH1 Short Enter

$V_{IN} = 5V$, $V_{OUT1} = 1.2V$, $I_{OUT1} = 0A$

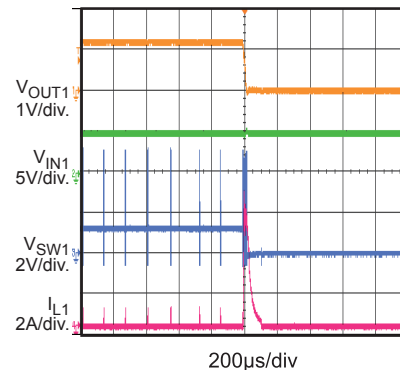

CH2 Short Enter

$V_{IN} = 5V$, $V_{OUT2} = 1.2V$, $I_{OUT2} = 0A$

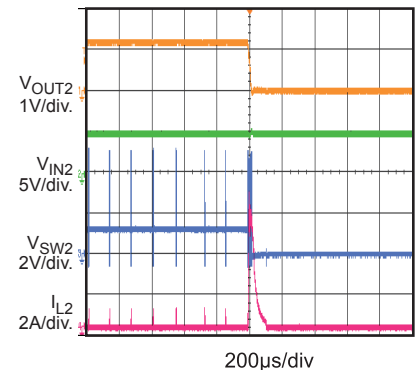

EVB TEST RESULTS (continued)

Performance waveforms are tested on the evaluation board.

$V_{IN1} = V_{IN2} = 5V$, $V_{OUT1} = V_{OUT2} = 1.2V$, $L1 = L2 = 1\mu H$, $T_A = 25^\circ C$, unless otherwise noted.

Output Ripple (Parallel)

$V_{IN} = 5V$, $V_{OUT} = 1.2V$, $I_{OUT} = 0A$

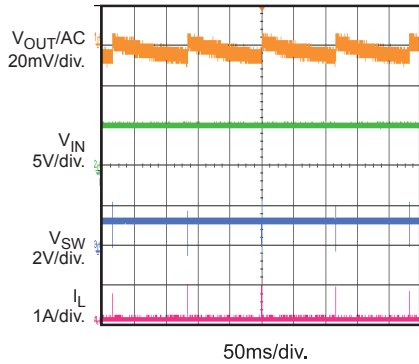

Output Ripple (Parallel)

$V_{IN} = 5V$, $V_{OUT} = 1.2V$, $I_{OUT} = 7A$

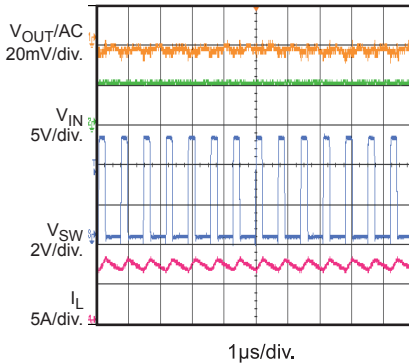

Short Enter (Parallel)

$V_{IN} = 5V$, $V_{OUT} = 1.2V$, $I_{OUT} = 0A$

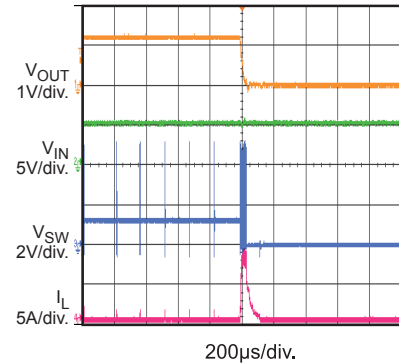

VIN Startup (Load Switch)

$V_{IN3} = 5V$, $V_{OUT3} = 5V$, $I_{OUT3} = 0A$

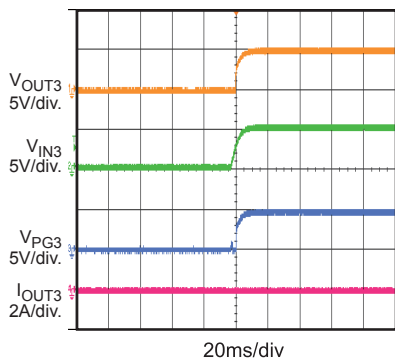

VIN Startup (Load Switch)

$V_{IN3} = 5V$, $V_{OUT3} = 5V$, $I_{OUT3} = 3A$

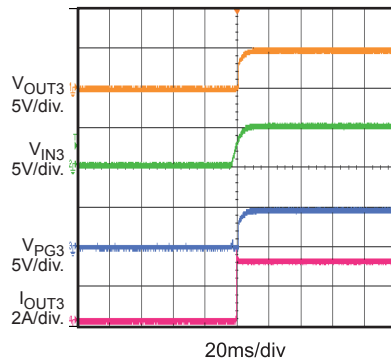

VIN Shutdown (Load Switch)

$V_{IN3} = 5V$, $V_{OUT3} = 5V$, $I_{OUT3} = 0A$

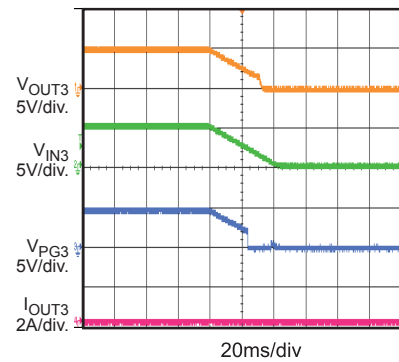

VIN Shutdown (Load Switch)

$V_{IN3} = 5V$, $V_{OUT3} = 5V$, $I_{OUT3} = 3A$

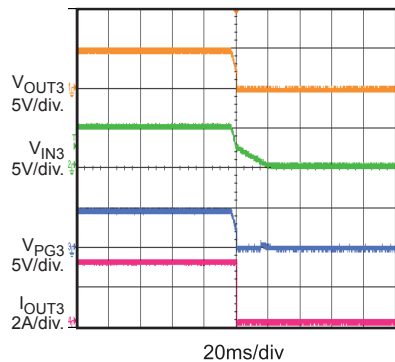

EN Startup (Load Switch)

$V_{IN3} = 5V$, $V_{OUT3} = 5V$, $I_{OUT3} = 0A$

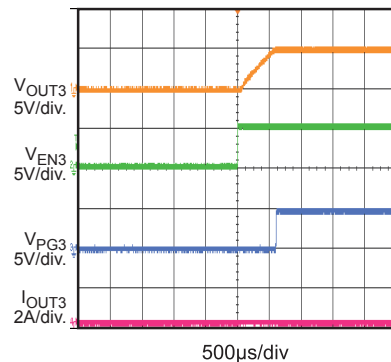

EN Startup (Load Switch)

$V_{IN3} = 5V$, $V_{OUT3} = 5V$, $I_{OUT3} = 3A$

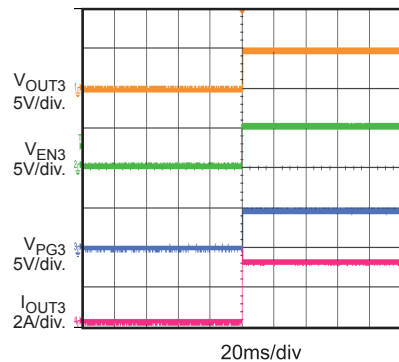

PRINTED CIRCUIT BOARD LAYOUT

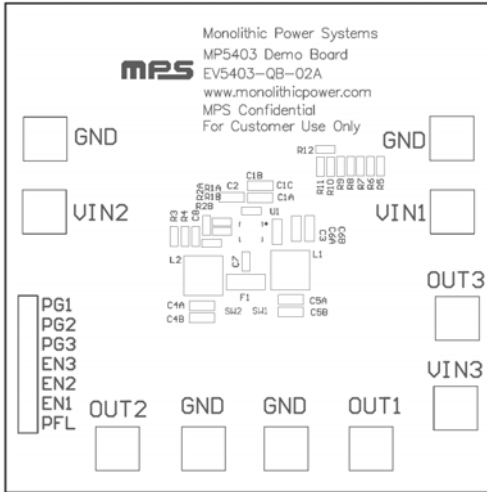

Figure 1—Top Silk Layer

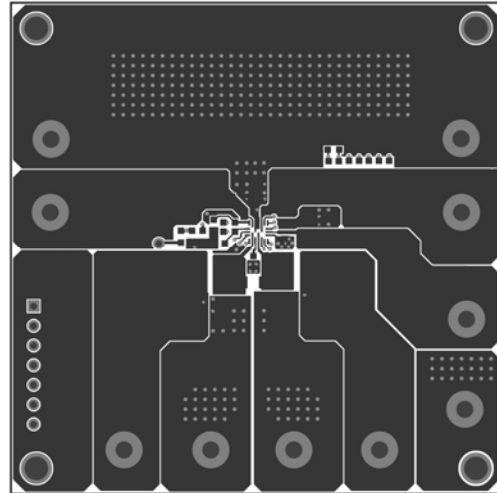

Figure 2—Top Layer

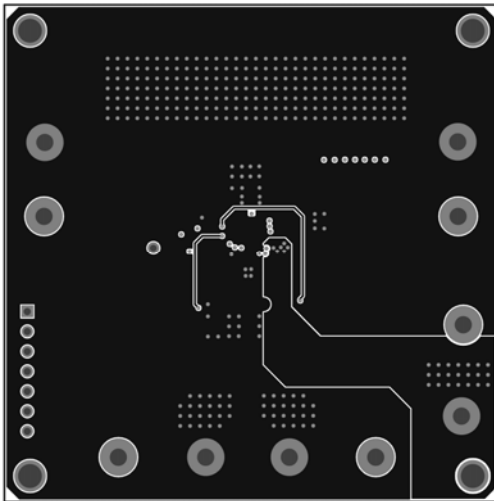

Figure 3—Bottom Layer

QUICK START GUIDE

The output voltage of this board is set externally by operating from +2.7V to +6V for V_{IN1} , +2V to +6V for V_{IN2} (if $V_{IN1} > 2.7V$) and +0.5V to +6V for V_{IN3} (if $V_{IN1} > 2.7V$). The default output voltage of this board is set to $V_{OUT1} = 1.2V$, $V_{OUT2} = 1.2V$.

1. Preset Power Supply to $2.7V \leq V_{IN1} \leq 6V$, $2V \leq V_{IN2} \leq 6V$, $0.5V \leq V_{IN3} \leq 6V$.
2. Turn Power Supply off.
3. Connect Power Supply terminals to:
 - a. Positive (+): V_{IN1} , V_{IN2} , V_{IN3} (connect to V_{IN1} or V_{IN2} or external power)
 - b. Negative (-): GND
4. Connect Load to:
 - a. Positive (+): VOUT1
 - b. Negative (-): GND
 - c. Positive (+): VOUT2
 - d. Negative (-): GND
 - e. Positive (+): VOUT3
 - f. Negative (-): GND
5. Turn Power Supply on after making connections.
6. To enable the MP5403, apply a voltage, $1.3V \leq V_{EN} \leq 6V$, to the EN pin. To disable the MP5403, apply a voltage, $V_{EN} < 0.4V$, to the EN pin. The EN pin can be connected to V_{IN} with a 100kΩ resistor for automatic startup.
7. The output voltage V_{OUT} can be changed by varying R2A or R2B. Calculate the new value by formula:

$$R2A(\text{or}R2B) = \frac{R1A(\text{or}R1B)}{\frac{V_{OUT}}{0.6V} - 1}$$

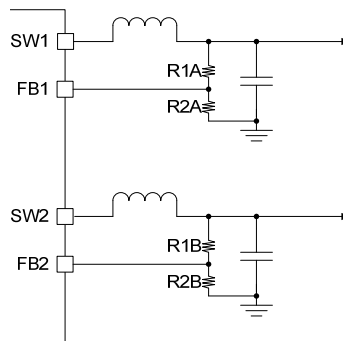

Figure 4

NOTICE: The information in this document is subject to change without notice. Please contact MPS for current specifications. Users should warrant and guarantee that third party Intellectual Property rights are not infringed upon when integrating MPS products into any application. MPS will not assume any legal responsibility for any said applications.