



The Future of Analog IC Technology®

EV4423-Q-00A

3A, 36V, Synchronous
Step Down Converter Evaluation Board

DESCRIPTION

The EV4423-Q-00A is an evaluation board for the MP4423/MPQ4423, a high-frequency, synchronous, rectified, step-down, switch-mode converter with build-in power MOSFETs. It offers a very compact solution to achieve a 3A continuous output current with excellent load and line regulation over a wide input supply range. The MP4423/MPQ4423 has synchronous mode operation for higher efficiency over the output current load range.

Current-mode operation provides fast transient response and eases loop stabilization.

Full protection features include over-current protection and thermal shut down.

The EV4423-Q-00A uses a minimal number of readily-available standard components, and is assembled and tested in space-saving QFN-8 (3mmx3mm) package.

ELECTRICAL SPECIFICATIONS

Parameter	Symbol	Value	Units
Input Voltage	V_{IN}	4-30(Continuous)/ 36(Transient)	V
Output Voltage	V_{OUT}	3.3	V
Output Current	I_{OUT}	3	A

FEATURES

- Wide 4V to 30V Continuous Operating Input Range
- 36V Input Transient Tolerance for Automotive Load Dump
- 85mΩ/55mΩ Low RDS(ON) Internal Power MOSFETs
- High-Efficiency Synchronous Mode Operation
- Default 410kHz Switching Frequency
- Synchronizes to a 200kHz to 2.2MHz External Clock
- High Duty Cycle for Automotive Cold-crank
- Power-Save Mode
- Internal Soft-Start
- Power Good
- OCP Protection and Hiccup
- Thermal Shutdown
- Output Adjustable from 0.8V
- Available in an QFN-8 (3mmx3mm) package
- Fully assembled and tested

APPLICATIONS

- Automotive
- Industrial Control System
- Distributed Power Systems

All MPS parts are lead-free and adhere to the RoHS directive. For MPS green status, please visit MPS website under Quality Assurance. "MPS" and "The Future of Analog IC Technology" are Registered Trademarks of Monolithic Power Systems, Inc.

EV4423-Q-00A EVALUATION BOARD



(L x W x H) 2.5" x 2.5" x 0.2"
(6.35cm x 6.35cm x 0.5cm)

Board Number	MPS IC Number
EV4423-Q-00A	MPQ4423GQ

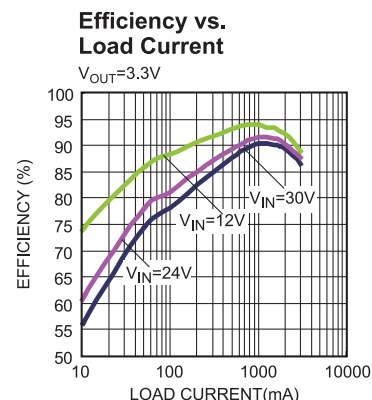

EVALUATION BOARD SCHEMATIC

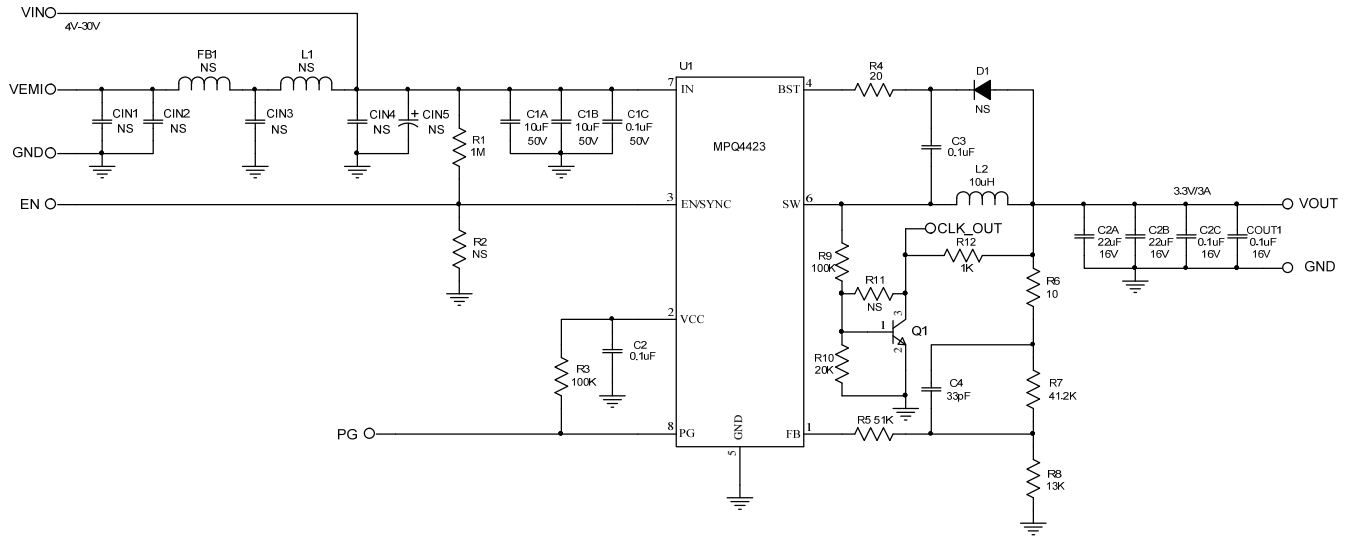

EV4423-Q-00A BILL OF MATERIALS

Qty	Ref	Value	Description	Package	Manufacture	Part Number
2	C1A,C1B	10µF	Ceramic Cap., 50V, X7R	1210	muRata	GRM32ER71H106KA12L
1	C1C	0.1µF	Ceramic Cap., 50V, X7R	0603	muRata	GRM188R71H104KA93D
2	C2A,C2B	22µF	Ceramic Cap., 16V, X7R	1210	muRata	GRM32ER71C226KE79
3	C2,C2C,C3	0.1µF	Ceramic Cap., 16V, X7R	0603	muRata	GRM188R71C104KA01D
1	C4	33pF	Ceramic Cap., 50V, C0G	0603	muRata	GRM1885C1H330JA01D
6	CIN1,CIN2, CIN3,CIN4, CIN5,COU1	NS				
1	D1	NS				
1	FB1	NS				
1	L1	NS				
1	L2	10µH	Inductor, 40.9mOhm DCR, 4.9A	SMD	Coilcraft	XAL5050-103ME
1	R1	1M	Film Res., 5%	0603	Yageo	RC0603JR-071ML
2	R3,R9	100k	Film Res., 1%	0603	Yageo	RC0603FR-07100KL
1	R4	20	Film Res., 1%	0603	Yageo	RC0603FR-0720RL
1	R5	51k	Film Res., 1%	0603	Yageo	RC0603FR-0751KL
1	R6	10	Film Res., 1%	0603	Yageo	RC0603FR-0710RL
1	R7	41.2k	Film Res., 1%	0603	Yageo	RC0603FR-0741K2L
1	R8	13k	Film Res., 1%	0603	Yageo	RC0603FR-0713KL
1	R10	20k	Film Res., 1%	0603	Yageo	RC0603FR-0720KL
1	R12	1k	Film Res., 1%	0603	Yageo	RC0603FR-071KL
2	R2,R11	NS				
1	Q1		Transistor, 40V, 0.2A	SOT-23	ON Semiconductor	MMBT3904LT1
1	U1		Step-Down Regulator	QFN3X3-8	MPS	MPQ4423GQ
5	VIN, VEMI, GND, VOUT, GND		2.0 Golden Pin		HZ	
5	EN/SYNC, GND,PG, GND, CLK_OUT		1.0 Golden Pin		HZ	

EVB TEST RESULTS

$V_{IN} = 12V$, $V_{OUT} = 3.3V$, $C_{OUT} = 2 \times 22\mu F$, $L = 10\mu H$, $T_A = +25^\circ C$, unless otherwise noted.

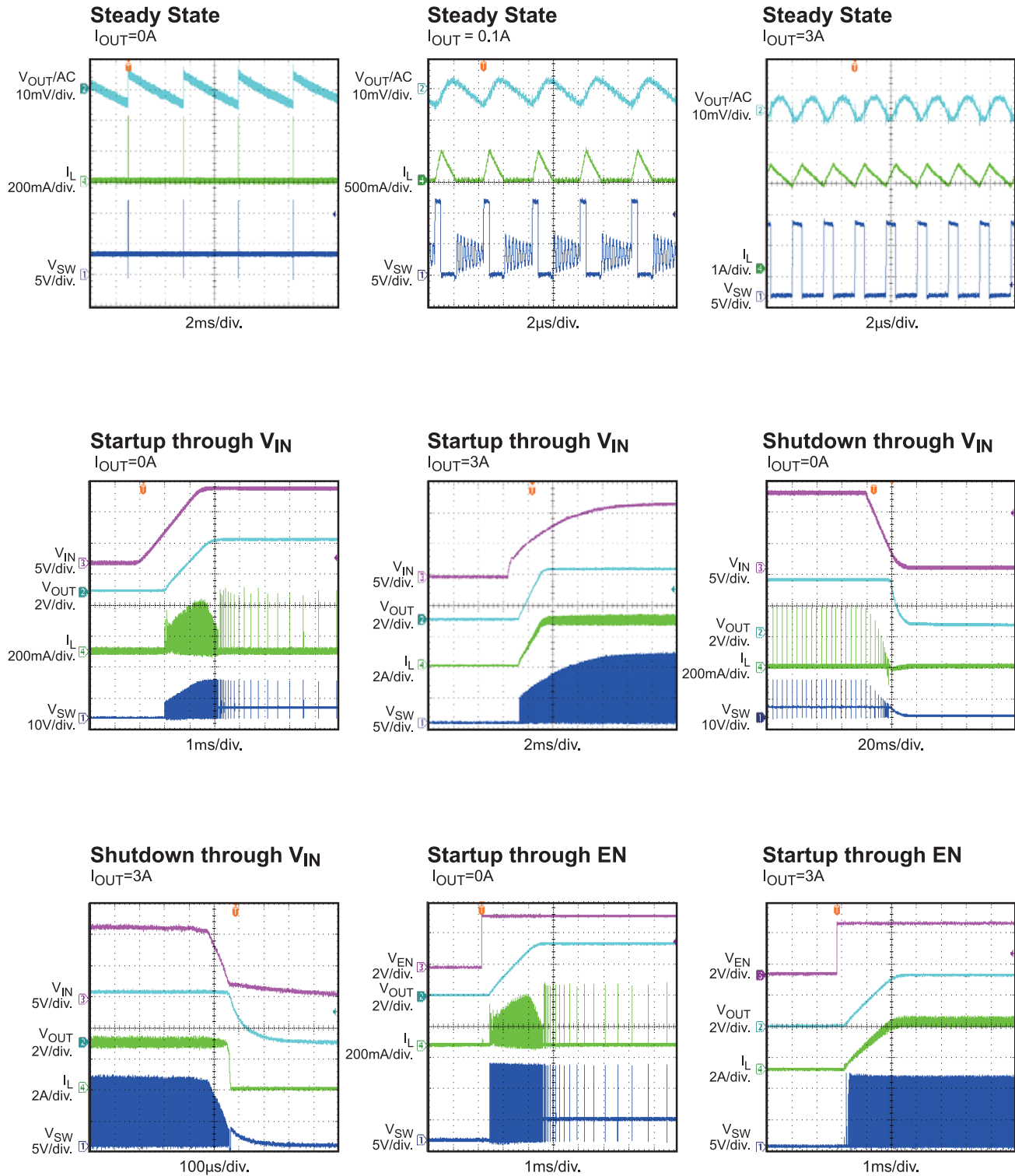

EVB TEST RESULTS (continued)

$V_{IN} = 12V$, $V_{OUT} = 3.3V$, $C_{OUT} = 2x22\mu F$, $L = 10\mu H$, $T_A = +25^\circ C$, unless otherwise noted.

Shutdown Through EN
 $I_{OUT} = 0A$

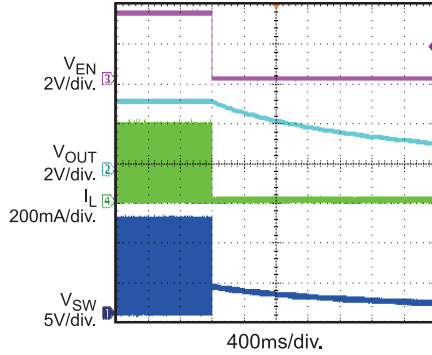

Shutdown Through EN
 $I_{OUT} = 3A$

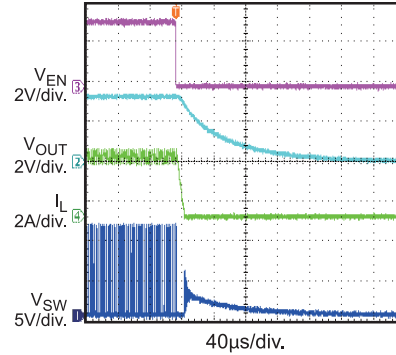

SCP Entry
 $I_{OUT} = 0A$ to Short Circuit

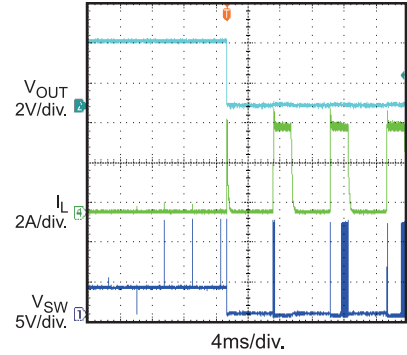

SCP Entry
 $I_{OUT} = 3A$ to Short Circuit

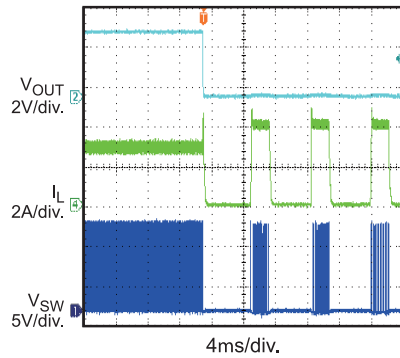

SCP Steady State

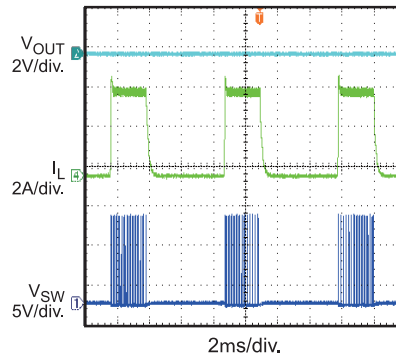

SCP Recovery
Short Circuit to $I_{OUT} = 0A$

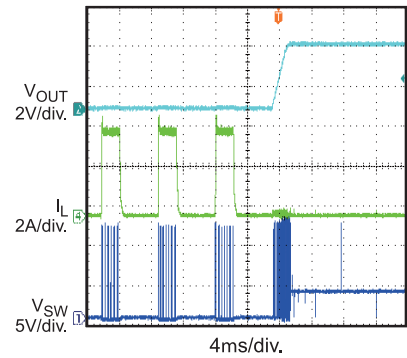

SCP Recovery
Short Circuit to $I_{OUT} = 3A$

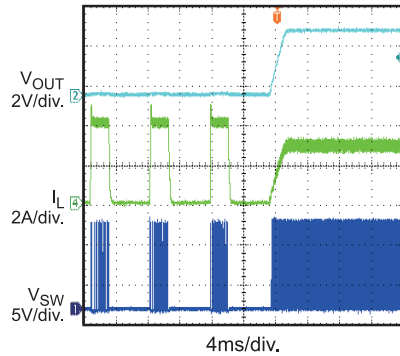

Load Transient
 $I_{OUT} = 1.5A \leftrightarrow 3A$, $1.6A/\mu s$

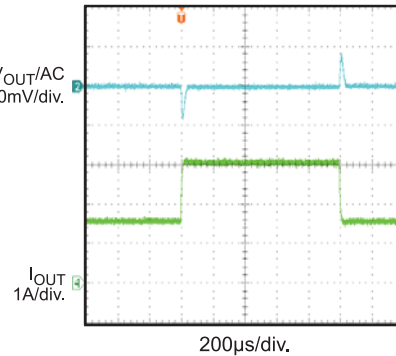

Load Dump
 $V_{IN} = 12V \leftrightarrow 36V$, $I_{OUT} = 3A$

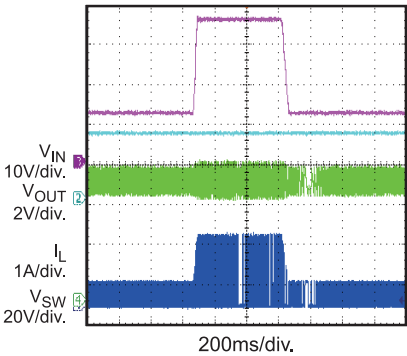

EVB TEST RESULTS (continued)

$V_{IN} = 12V$, $V_{OUT} = 3.3V$, $C_{OUT} = 2 \times 22\mu F$, $L = 10\mu H$, $T_A = +25^\circ C$, unless otherwise noted.

Cold-Crank

$V_{OUT} = 3.3V$, $I_{OUT} = 3A$

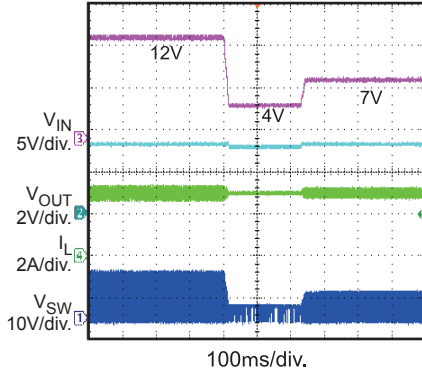

Cold-Crank

$V_{OUT} = 5V$, $I_{OUT} = 3A$

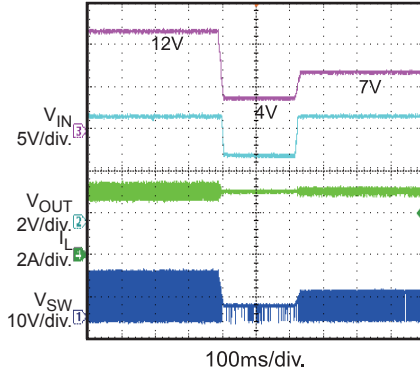

Power Good through EN Start-Up

$I_{OUT} = 0A$

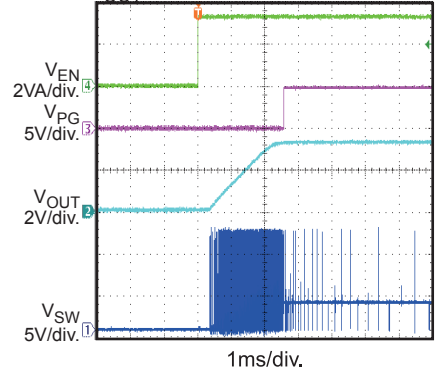

Power Good through EN Shut-Down

$I_{OUT} = 0A$

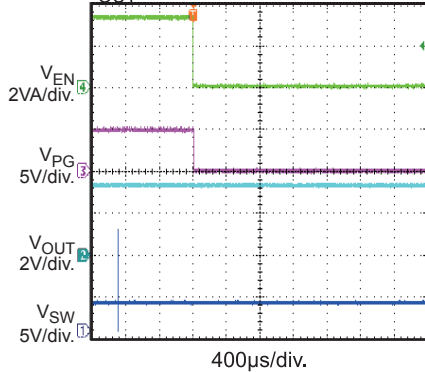

CLK_OUT Inverted from SW

$I_{OUT} = 3A$

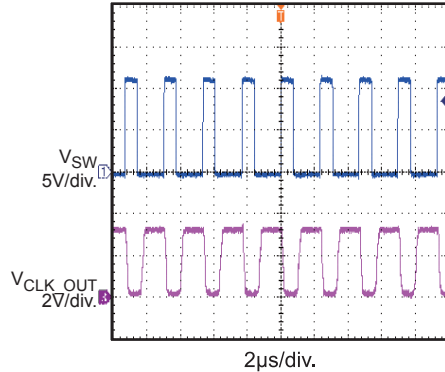

PRINTED CIRCUIT LAYOUT

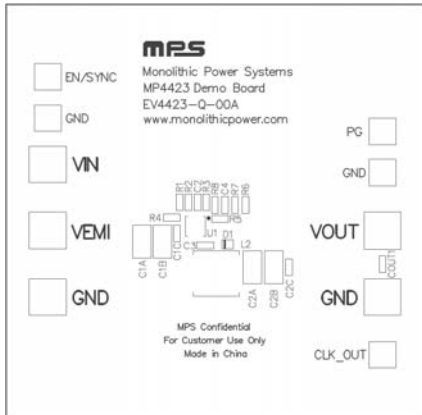

Figure1 – Top Silk Layer

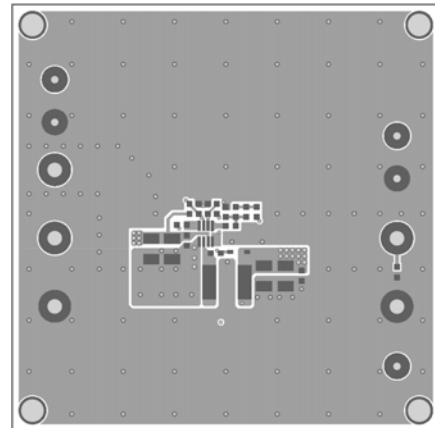

Figure 2 – Top Layer

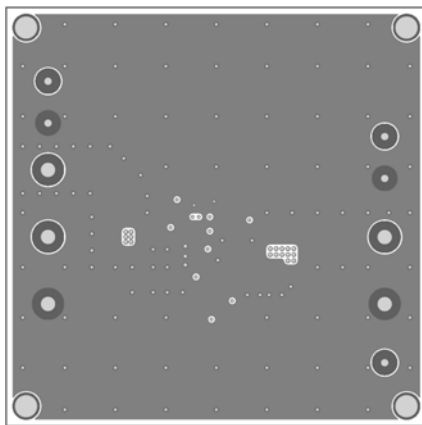

Figure3 – Inner Layer 1

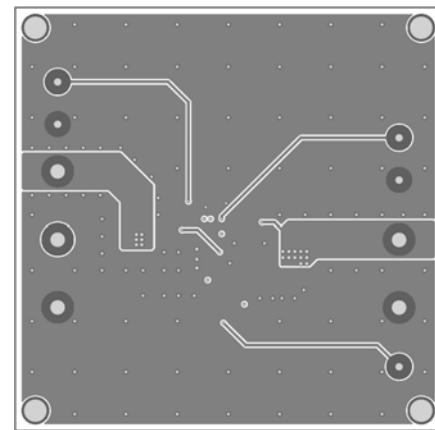

Figure 4 – Inner Layer 2

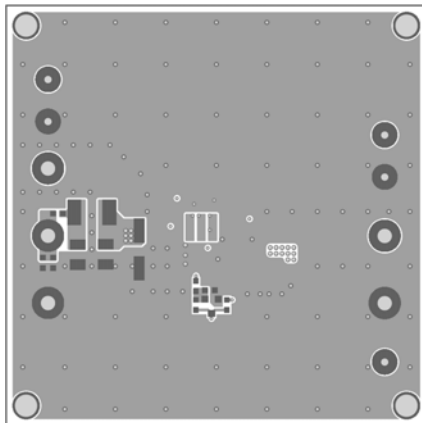

Figure5 – Bottom Layer

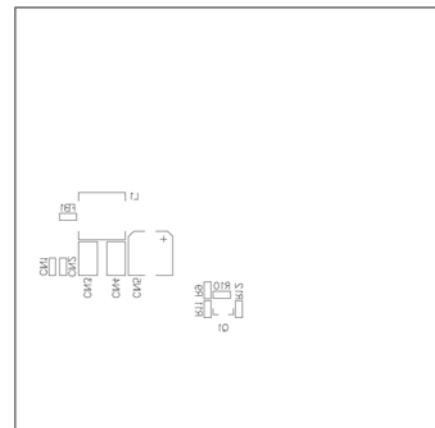

Figure 6 – Bottom Silk Layer

QUICK START GUIDE

1. Connect the positive and negative terminals of the load to the VOUT and GND pins respectively.
2. Preset the power supply output to between 4V to 30V and then turn it off.
3. Connect the positive and negative terminals of the power supply output to the VIN and GND pins respectively.
4. Turn the power supply on. The MP4423/MPQ4423 will automatically startup.
5. To use the Enable function, apply a digital input to the EN pin. Drive EN higher than 1.65V to turn on the regulator, drive EN less than 1.05V to turn it off.
6. Connect the EN input pin through a pull-up resistor to any voltage connected to the VIN pin. Make sure the pull-up resistor big enough to limit the EN input current to less than 150 μ A. For example, with 12V connected to V_{IN}, $R_{PULLUP} \geq (12V - 6.5V) \div 150\mu A = 36.7k\Omega$.
7. Connect the EN pin directly to a voltage source without any pull-up resistor requires limiting voltage amplitude to $\leq 6V$ to prevent damage to the Zener diode.
8. Connect the EN input pin with an external clock with a range of 200kHz to 2.2MHz after output voltage is set to synchronize the internal clock rising edge to the external clock rising edge. The pulse width of external clock signal should be less than 1.7 μ s.
9. Use R7 and R8 to set the output voltage with $V_{FB}=0.792V$. For R7=41.2k Ω , R8 can be determined by:

$$R8 = \frac{0.792 * 41.2}{V_{OUT} - 0.792} k\Omega$$

Follow the Application Information section in the device datasheet to recalculate the compensation, inductor and output capacitor values when output voltage is changed.

10. CLK_OUT is a signal inverted to SW and can be used as other buck's sync signal to get 180 degree out of phase. The high voltage of CLK_OUT is equal to the output voltage of the board, so make sure it is safe for the synchronized part when the output voltage setting value is high.

NOTICE: The information in this document is subject to change without notice. Please contact MPS for current specifications. Users should warrant and guarantee that third party Intellectual Property rights are not infringed upon when integrating MPS products into any application. MPS will not assume any legal responsibility for any said applications.