

DESCRIPTION

The EV4033-K-00A Evaluation Board is designed to demonstrate the capabilities of MP4033 with ripple suppressor. The MP4033 is a primary-side-control offline LED lighting controller which can achieve high power factor and accurate current for Triac dimmable LED lighting application. Its adaptive dimmer type detection and phase-cut-based dimming control can achieve good dimmer compatibility and deep dimming range.

It works in boundary conduction mode for reducing the MOSFET and Diode switching losses. The new ripple suppressor can obviously reduce the output current ripple and escape the flicker or shimmer happened in deep dimming situation with a little influence in efficiency.

The EV4033-K-00A is typically designed for driving a 10W Triac dimmable LED bulb with 24V_{TYP}, 420mA LED load from 198VAC to 265VAC, 50Hz.

The EV4033-K-00A has an excellent efficiency and meets IEC61547 surge immunity, IEC61000-3-2 Class C harmonics and EN55015 conducted EMI requirements. It has multi-protection function as over-voltage protection; winding short circuit protection; output short-circuit protection, cycle by cycle current limit, etc.

ELECTRICAL SPECIFICATION

Parameter	Symbol	Value	Units
Input Voltage	V _{IN}	198 to 265	VAC
Output Voltage	V _{OUT}	24	V
LED Current	I _{LED}	420	mA
Output Power	P _{OUT}	10	W
Efficiency (full load)	η	>83	%
Power Factor	PF	>0.8	
THD	THD	<28	%

FEATURES

- Fast Start up
- Adaptive Dimmer Type Detection and Phase-Cut-Based Dimming Control
- Triac Dimmable, with good dimmer compatibility and deep dimming range
- The dimming curve meets standard SSL6
- Direct PWM Dimming
- Real current control without secondary-feedback circuit
- Programmable Current Fold-back to Prolong the LED lifetime (NTC)
- Accurate Line & Load Regulation
- High power factor over 198VAC to 265VAC
- Boundary conduction mode improves efficiency
- Input UVLO
- Cycle-by-cycle current limit
- Over-voltage protection (OVP)
- Output Short-circuit protection (SCP)
- Winding short circuit protection
- ZCD Pin short circuit protection
- Over-temperature protection (OTP)
- Fit inside A19 bulb enclosure

APPLICATIONS

- Solid State Lighting
- Industrial & Commercial Lighting
- Residential Lighting

All MPS parts are lead-free and adhere to the RoHS directive. For MPS green status, please visit MPS website under Quality Assurance. "MPS" and "The Future of Analog IC Technology", are Registered Trademarks of Monolithic Power Systems, Inc.



Warning: Although this board is designed to satisfy safety requirements, the engineering prototype has not been agency approved. Therefore, all testing should be performed using an isolation transformer to provide the AC input to the prototype board.

EV4033-K-00A EVALUATION BOARD

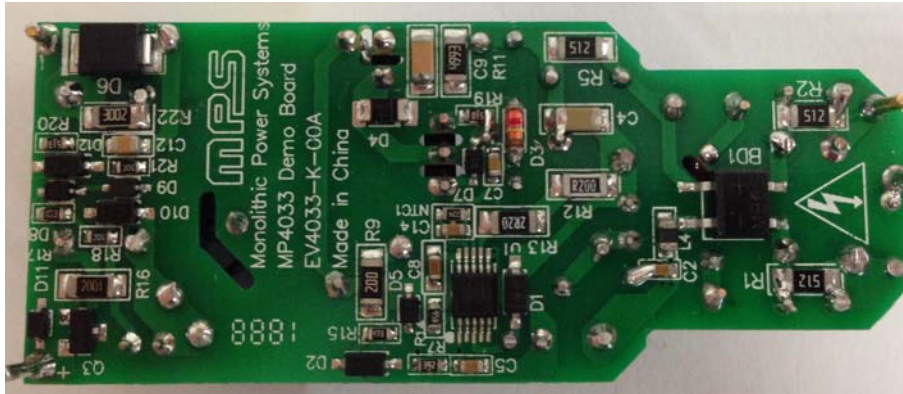

(L x W x H) 62mm x 25mm x 23mm

Board Number	MPS IC Number
EV4033-K-00A	MP4033GK

EVALUATION BOARD SCHEMATIC

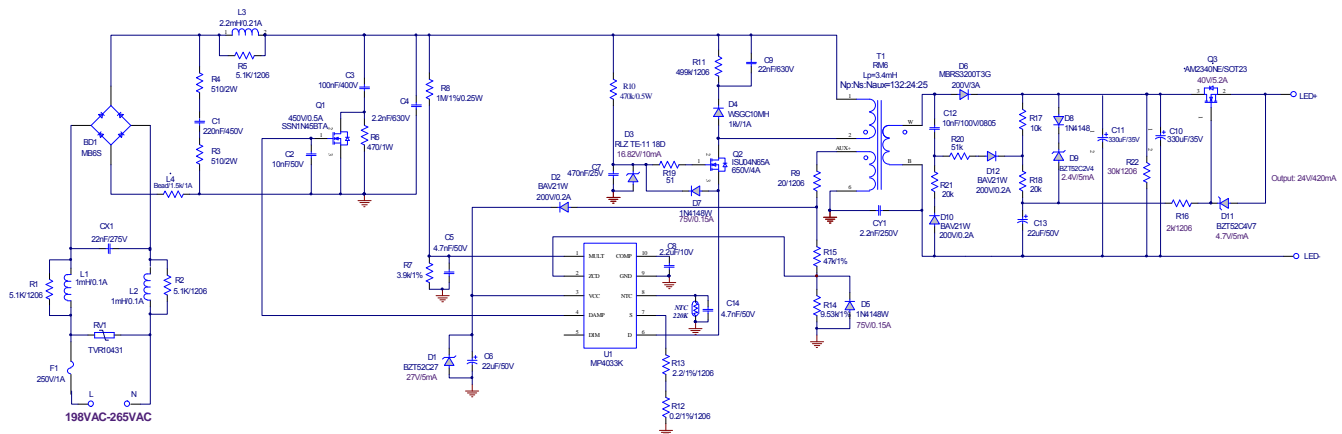

Figure 1—Schematic

CIRCUIT DESCRIPTION

The EV4033-K-00A is configured in a single-stage Flyback topology; it uses primary-side-control which can mostly simplify the schematic and get a cost effective BOM. It can also achieve high power factor and accurate LED current.

F1, RV1, L1, L2, L3, L4, R1, R2, R5, CX1, BD1, C4 and C3 compose the input stage. F1 fuses the AC input to protect for the component failure or some excessive short events. RV1 is used for surge test. L1, L2, L3, L4, R1, R2, R5, CX1, C3 and C4 associated with CY1 form the EMI filter which can meet the standard EN55015. The diode rectifier BD1 rectifies the input line voltage. Small bulk CBB capacitor C3 is used for a low impedance path for the primary switching current, to maintain high power factor, the capacitance of C3 should be selected with low value.

R6, Q1 with C2 compose the damping circuit for reducing the inrush current at the dimmer turning on time. The circuit let the inrush current flow through R6 at first when triac dimmer turns on. Then Q1 turns on and shorts R6, this can save power from R6.

R4, R3, C1 are used as a bleeder circuit which keeping the triac current above the minimum holding current after triac turns on.

R8, R7, C5 provide sine wave reference for the primary peak current to get an active PFC function. The divided voltage should be lower than the max voltage rating of MULT pin.

R9, D1, C6 and D2 are used to supply the power for MP4033. A 22 μ F bulk capacitor C6 is selected to maintain the supply voltage. At

start-up, C6 is first charged up through the external MOSFET Q2 and internal charging circuit, when the VCC voltage reaches 10V, the internal charging circuit stops charging. Then the power supply is taken over by the auxiliary winding through R9, D2.

R10, C7, R19, D3 and D7 are used for the gate drive of the external MOSFET Q2.

R15, R14 and D5 are used to detect the auxiliary winding to get the transformer magnetizing current zero crossing signal for realizing the boundary conduction operation, and also monitor the output OVP condition. The OVP voltage is set by the divider ratio of R15 and R14.

R12, R13 are primary sensing resistors for primary side current control. The value of R12, R13 set the output LED current. C9, R11, D4 are used to damp the leakage inductance energy so the drain voltage can be suppressed at a safe level.

Diode D6 rectifies the secondary winding voltage and the capacitor C10, C11 are the output filter. The resistor R22 is placed as pre-load to limit the output voltage rise too high in open load condition.

R16, R17, R18, R20, R21, C12, D8, D9, D10, D11, D12, C13 and Q3 compose the ripple suppressor. R17, R18 and C13 offer a stable drive voltage to Q3. D8 and D9 compose the fast start up circuit, which help charge C13 quickly at the moment power on. D10, R21, R20, C12, D12 and R17 add a bias voltage to the gate of Q3, which will help save the power loss of the ripple suppressor obviously.

EV4033-K-00A BILL OF MATERIALS

Qty	Des	Value	Description	Package	Manufacturer	Manufacturer_P/N
1	BD1	MB6S	Bridge, 600V, 0.5A	SOIC-4	Taiwan Semiconductor	MB6S
1	C1	220nF/450V	CBB,450V	DIP	Fala	C222S224K31C000
1	C2	10nF/50V	Ceramic Cap,X7R,50V	0603	muRata	GRM188R71H103KA01D
1	C3	100nF/450V	104/450V	DIP	Fala	C222S104K30C000
1	C4	2.2nF/630V	Ceramic Cap, X7R	1206	muRata	GRM31BR72J222KW01L
1	C5	4.7nF/50V	Ceramic Cap,X7R,50V	0603	muRata	GRM188R71H472KA01D
1	C6	22uF/50V	Electrolytic Capacitor; 50V;Electrolytic	DIP	Jianghai	CD281L-50V22
1	C7	470nF/50V	Ceramic Cap,X7R,50V	0603	muRata	GRM188R71E474KA12D
1	C8	2.2uF/10V	Ceramic Cap, 10V,X7R	0603	muRata	GRM188R71A225KE15D
1	C9	22nF/630V	Ceramic Cap, 630V, X7R	1206	TDK	C3216X7R2J223K
2	C10, C11	330uF/35V	Electrolytic Capacitor, 35V, Electrolytic	DIP	JiangHai	CD263-35V330
1	C14	4.7nF/50V	Ceramic Cap,50V,X7R	0603	muRata	GRM188R71H472KA01D
1	CX1	22nF/275V	X Capacitor,275V	DIP	Kaili	PX223K3IB19L270D9R
1	CY1	2.2nF/4000V	Y Capacitor,4000V	DIP	Hongke	JNK12E222MY02N
1	D1	BZT52C27	Zener Diode, 27V, 2mA	SOD-123	Diodes	BZT52C27
1	D2	BAV21W	Diode;200V;0.2A;	SOD-123	Diodes	BAV21W-7-F
1	D3	RLZ TE-11 18D	Zener DIODES 16.82V, 10mA	SOD-123	ROHM	RLZ TE-11 18D
1	D4	WSGC10MH	Diodes,1000V,1A	SOD-123	ZOWIE	WSGC10MH
2	D5, D7	1N4148WS	Diode;75V;0.15A;	SOD-323	Diodes	1N4148WS-7-F
1	D6	MBRS320T3 G	Diode;200V;3A	SMB	Qianlongxin	MBRS320T3G
1	F1	250V/1A	Fuse	DIP	any	
2	L1, L2	Inductor,1mH	Inductor,1mH/0.1A	DIP	Bangdayuan	CKL0410-102
1	L3	Inductor,2.2mH	Inductor,2.2mH/0.21A	DIP	Wurth	744741222
1	L4	BEAD	Magnetic Bead 1.5k/1A	0805	Wurth	742792097
1	NTC	220kΩ	Thermistor	0603	muRata	MCP13WM224E03R8
1	Q1	SSN1N45BTA	N-Channel Mosfet 450V;4250/10V;8.5	TO-92	Fairchild	SSN1N45BTA
1	Q2	ISU04N65A	N-Channel MOSFET, 650V, 4A	TO-251	IPS	ISU04N65A

EV4033-K-00A BILL OF MATERIALS (continued)

Qty	Des	Value	Description	Package	Manufacturer	Manufacturer_P/N
3	R1, R2, R5	5.1kΩ	Film Resistor;1%;1/4W	1206	Yageo	RC1206FR-075K1L
2	R3, R4	510Ω	DIP,2W RESISTOR	DIP	any	510Ω/2W
1	R6	470Ω	DIP,1W RESISTOR	DIP	any	470Ω/1W
1	R7	3.9kΩ	Film RES, 1%	0603	Yageo	RC0603FR-073K9L
1	R8	1MΩ	DIP,0.25W RESISTOR	DIP	any	1MΩ/0.25W
1	R9	20Ω	Film RES;1%	1206	Yageo	RC1206FR-0720RL
1	R10	470kΩ/0.5W	Resistor;5%;0.5W	DIP	any	470kΩ/0.5W
1	R11	499kΩ	Film RES, 1%	1206	Yageo	RC1206FR-07499KL
1	R12	200mΩ	Film RES, 1%	1206	Yageo	RC1206FR-070R2L
1	R13	2.2Ω	Film RES, 1%	1206	Royalohm	1206TF2R20
1	R14	9.53kΩ	Film RES, 1%	0603	Yageo	RC0603FR-079K53L
1	R15	47kΩ	Film RES, 1%	0603	Yageo	RC0603FR-0747kL
1	R19	51Ω	Film RES,1%	0603	Yageo	RC0603FR-0751RL
1	R22	30kΩ	Resistor;1%	1206	Yageo	RC1206FR-0730kL
1	RV1	TVR10431KS Y	430V/2500A	DIP	TKS	TVR10431KSY
1	T1	RM6	RM6, Lp=3.4mH Np:Ns:Naux=132:24: 25,	RM6	Emei	FX0342
1	U1	MP4033GK	MP4033GK	MSOP10	MPS	MP4033GK
1	C12	10nF/250V	Ceramic Cap,X7R,250V	0805	TDK	C2012X7R2E103K
1	C13	22uF/50V	Electrolytic Capacitor; 50V;Electrolytic	DIP	Jianghai	CD281L-50V22
2	D10, D12	BAV21W	Diode;200V;0.2A;	SOD-123	Diodes	BAV21W-7-F
1	D11	BZT52C4V7 S	Zener Diode, 4.7V, 5mA	SOD-323	Diodes	BZT52C4V7S
1	D9	BZT52C2V4 S	Zener Diode, 2.4V, 5mA	SOD-323	Diodes	BZT52C2V4S
1	D8	1N4148WS	Diode;75V;0.15A;	SOD-323	Diodes	1N4148WS-7-F
1	Q3	AM2340NE	N-channel MOSFET, 40V,5.2A	SOT23	Analog Power	AM2340NE
1	R16	2kΩ	Film RES;1%	1206	Yageo	RC1206FR-072KL
1	R17	10kΩ	Film RES;1%	0603	Yageo	RC0603FR-0710KL
2	R18, R21	20kΩ	Film RES;1%	0603	Yageo	RC0603FR-0720KL
1	R20	51kΩ	Film RES;1%	0603	Yageo	RC0603FR-0751KL

Note: the components in **blue** compose the ripple suppressor. It is optional.

TRANSFORMER SPECIFICATION

Electrical Diagram

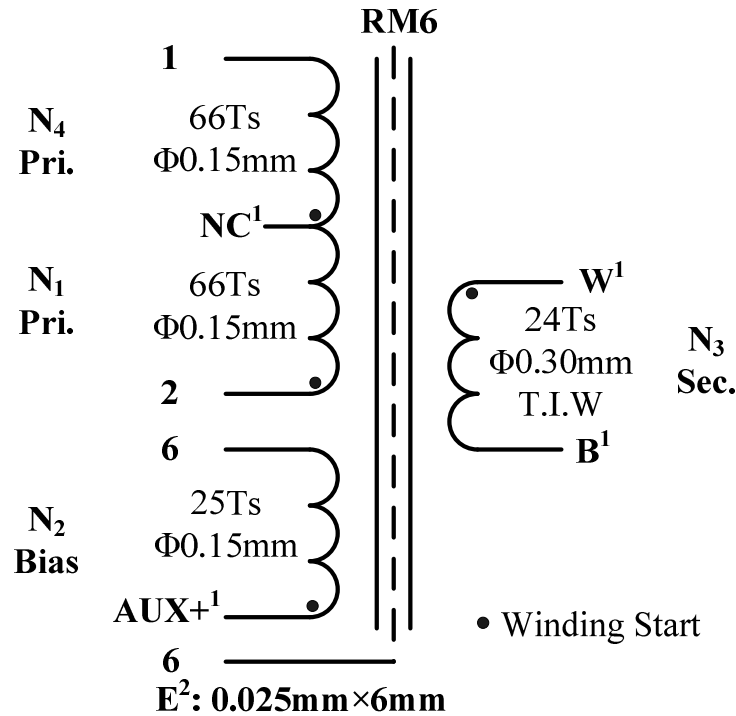

Figure 4—Transformer Electrical Diagram

Notes:

1. Don't connect Y to any pin of Bobbin.
2. W and B are pulled out and marked with different Teflon tube.
3. E₁ is one layer of cooper foil applied to core, and connected to PIN3 by a wire.

Winding Diagram

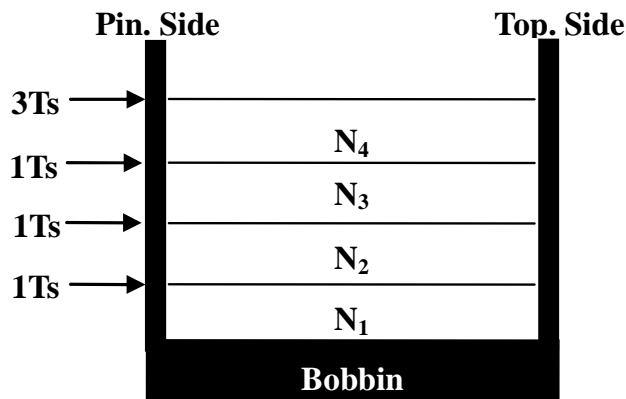

Figure 5—Winding Diagram

Winding Order

Winding No.	Tape Layer Number	Start & End	Magnet Wire Φ (mm)	Turns
N ₁	0	2→NC	0.15mm * 1	66
N ₂	1	Aux+→6	0.15mm * 1	25
N ₃	1	W→B	0.30mm (T.I.W)	24
N ₄	1	NC→1	0.15mm * 1	66
E ₁	3		One layer Cooper foil	

Electrical Specifications

Electrical Strength	60 second, 60Hz, from PRI. to SEC.	2500VAC
	60 second, 60Hz, from PRI. to CORE.	1000VAC
	60 second, 60Hz, from SEC. to CORE.	1000VAC
Primary Inductance	Pins 1 - 2, all other windings open, measured at 100kHz, 0.1 VRMS	3.4mH±8%
Primary Leakage Inductance	Pins 1 - 2 with all other pins shorted, measured at 100kHz, 0.1 VRMS	43μH±10%

Materials

Item	Description
1	Core: RM6, UI=2500±25%, AL=221.5H/N ² ±2% GAP, ACME P4 or equivalent
2	Bobbin: RM6, 3+3PIN RMMOVE PIN6 1SECT TH, PM9630 UL94V-0
3	Wire: Φ 0.16mm, 2UEW, CLASS F or equivalent
4	Triple Insulation Wire: great Φ 0.30mm, TRW(B) or equivalent
5	TEFLON TUBE: TFL AWG#30
6	TEFLON TUBE: TFL AWG#24
7	Tape: 6.5mm(W)×0.06mm(TH)
8	Tape: 4.0mm(W)×0.06mm(TH)
9	Varnish: JOHN C. DOLPH CO, BC-346A or equivalent
10	Solder Bar: CHEN NAN: SN99.5/Cu0.5 or equivalent

EVB TEST RESULTS

Performance Data

Efficiency, PF and THD

f (Hz)	Vin(V)	Pin(W)	Vo(V)	Io(mA)	Po(W)	Efficiency(%)	PF	THD(%)
50	198	11.53	23.24	419	9.74	84.45	0.938	17.00
	210	11.55	23.24	420	9.76	84.51	0.925	19.00
	220	11.57	23.23	421	9.78	84.53	0.914	20.10
	230	11.61	23.23	422	9.80	84.44	0.902	21.10
	240	11.65	23.23	422	9.80	84.15	0.890	22.60
	250	11.70	23.23	423	9.83	83.99	0.877	23.40
	260	11.75	23.23	424	9.85	83.83	0.864	24.80
	265	11.78	23.23	424	9.85	83.61	0.857	25.50

Dimming Compatibility (No Flicker with these 19 different Dimmers)

Manufacturer	Part No.	Power Stage	Dimming Type	I _{max} (mA)	I _{min} (mA)	Dimming ratio
GIRA	0302 00/101	60-600W	Leading	533	30	5.63%
MIKA	433/4	60-400W	Leading	531	91	17.14%
Berker	283010	60-400W	Leading	531	43	8.10%
JUNG	225 NV DE	20-500W/VA	Leading	531	22	4.14%
JUNG	225 NV DE	20-500W/VA	Leading	532	105	19.74%
Berker	286610	20-500W	Leading	531	40	7.53%
JUNG	266 GDE	60-600W	Leading	527	33	6.26%
EMC	PROP400U	40-400W	Leading	531	28	5.27%
Busch	2247U	500W/VA	Leading	531	50	9.42%
Busch	2200..	60-400W	Leading	530	54	10.19%
Busch	6513 U-102	420W/VA	Trailing	531	50	9.42%
Grundtyp	ET1_53850	25~300W	Trailing	445	40	8.99%
MIKA	433 HAB	20-315W	Trailing	406	46	11.33%
MIKA?	EIM-585	20-300W	Trailing	458	1	0.22%
Busch	6591U-101	420W/VA	Trailing	462	39	8.44%
Busch	6519U	550W/VA	Trailing	527	50	9.49%
JUNG	225 TDE	20-525W	Trailing	504	44	8.73%
SIEMENS	5TC8 284	20-600W	Trailing	481	30	6.24%
LICHTREGLER	T46s	20~315W	Trailing	514	61	11.87%
JUNG	254 UDIE 1	50-420W/VA	Trailing	527	71	13.47%
Berker	286110	50-420W	Trailing	526	72	13.69%

Electric Strength Test

Primary circuit to secondary circuit electric strength testing was completed according to IEC61347-1 and IEC61347-2-13.

Input and output was shorted respectively. 3750VAC/50Hz sine wave applied between input and output for 1min, and operation was verified.

Surge Test

Line to Line 500V and Line to Power Earth 1kV surge testing was completed according to IEC61547. Input voltage was set at 230VAC/50Hz. Output was loaded at full load and operation was verified following each surge event.

Surge Level (V)	Input Voltage (VAC)	Injection Location	Injection Phase (°)	Test Result (Pass/Fail)
500	230	L to N	90	Pass
-500	230	L to N	270	Pass
1000	230	L to PE	90	Pass
-1000	230	L to PE	270	Pass
1000	230	N to PE	90	Pass
-1000	230	N to PE	270	Pass

Thermal Test

Test without dimmer and with dimmer at 90% dimming on phase.

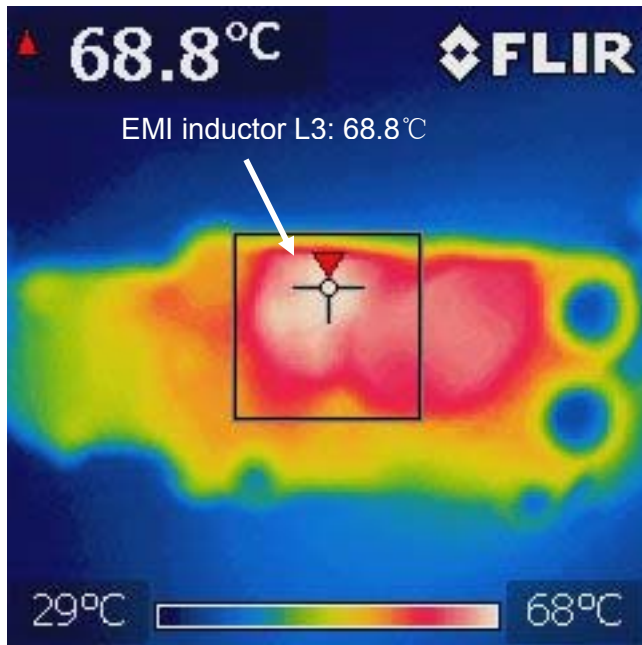

Without dimmer

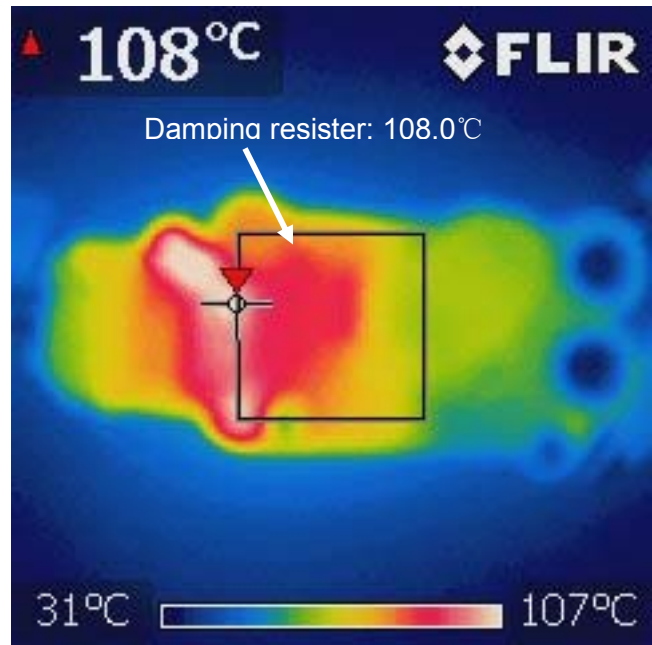

With dimmer at 90% dimming on phase

EVB TEST RESULTS

Performance waveforms are tested on the evaluation board.

$V_{IN}=230V_{AC}/50Hz$, 8 LEDs in series, $I_{LED}=420mA$, $V_{OUT}=24V$, $L_P=3.4mH$, $N_P:N_S:N_{AUX} = 132:24:25$

Conducted EMI L-Line

$V_{IN} = 230V_{AC}/50Hz$, Full Load,
RBW = 9kHz, MT = 20ms

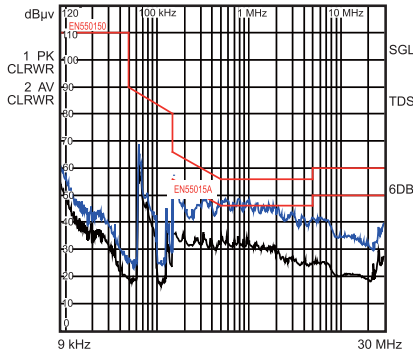

Conducted EMI N-Line

$V_{IN} = 230V_{AC}/50Hz$, Full Load,
RBW = 9kHz, MT = 20ms

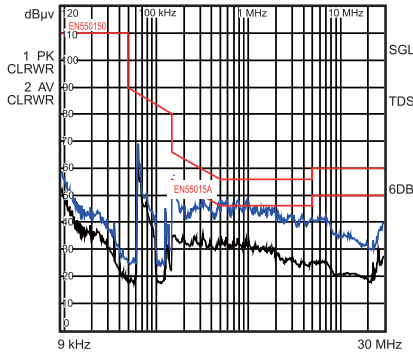

Radiated EMI

Tested by CDN,
 $V_{IN}=230V_{AC}/50Hz$, Full Load

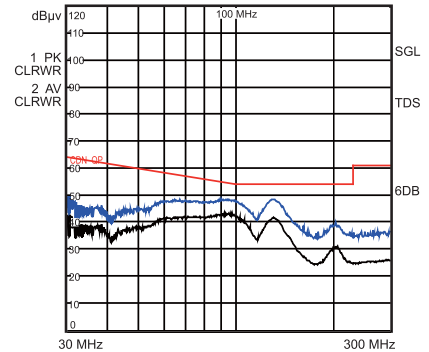

Dimming Curve

$V_{IN}=120V_{AC}/60Hz$, Full Load,
with Different Dimmers

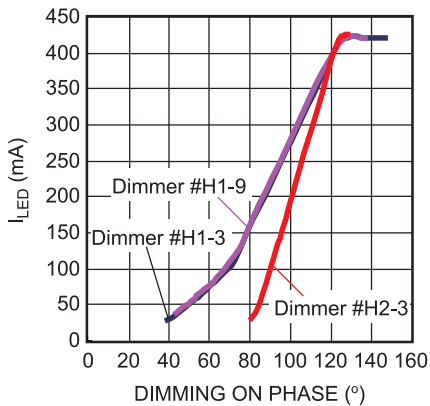

Line Regulator

Full Load

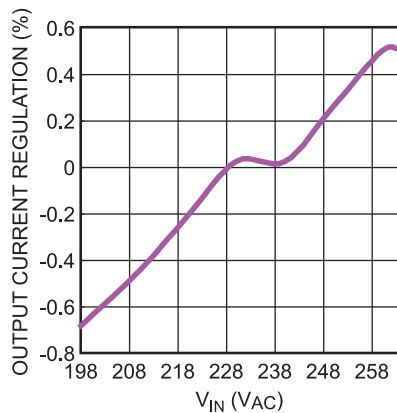

Efficiency vs. V_{IN}

$V_{IN}=(198-265)V_{AC}/50Hz$, Full Load

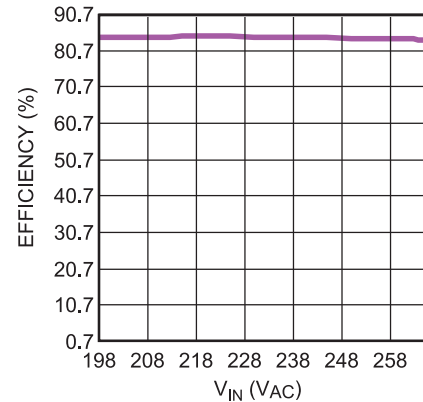

PF vs. V_{IN}

$V_{IN}=(198-265)V_{AC}/50Hz$, Full Load

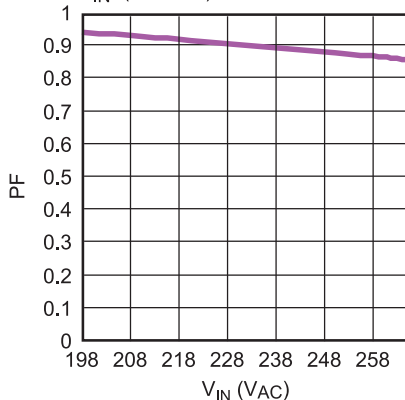

THD vs. V_{IN}

$V_{IN}=108-132V_{AC}/60Hz$, Full Load

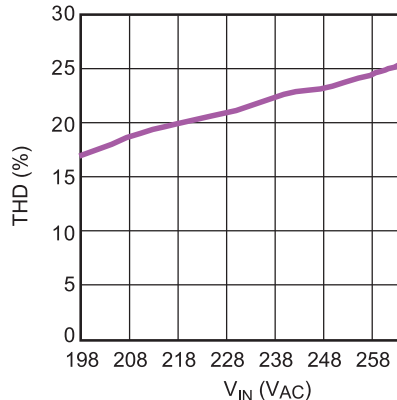

EVB TEST RESULTS *(continued)*

Performance waveforms are tested on the evaluation board.

$V_{IN}=230VAC/50Hz$, 8 LEDs in series, $I_{LED}=420mA$, $V_{OUT}=24V$, $L_P=3.4mH$, $N_P:N_S:N_{AUX} = 132:24:25$.

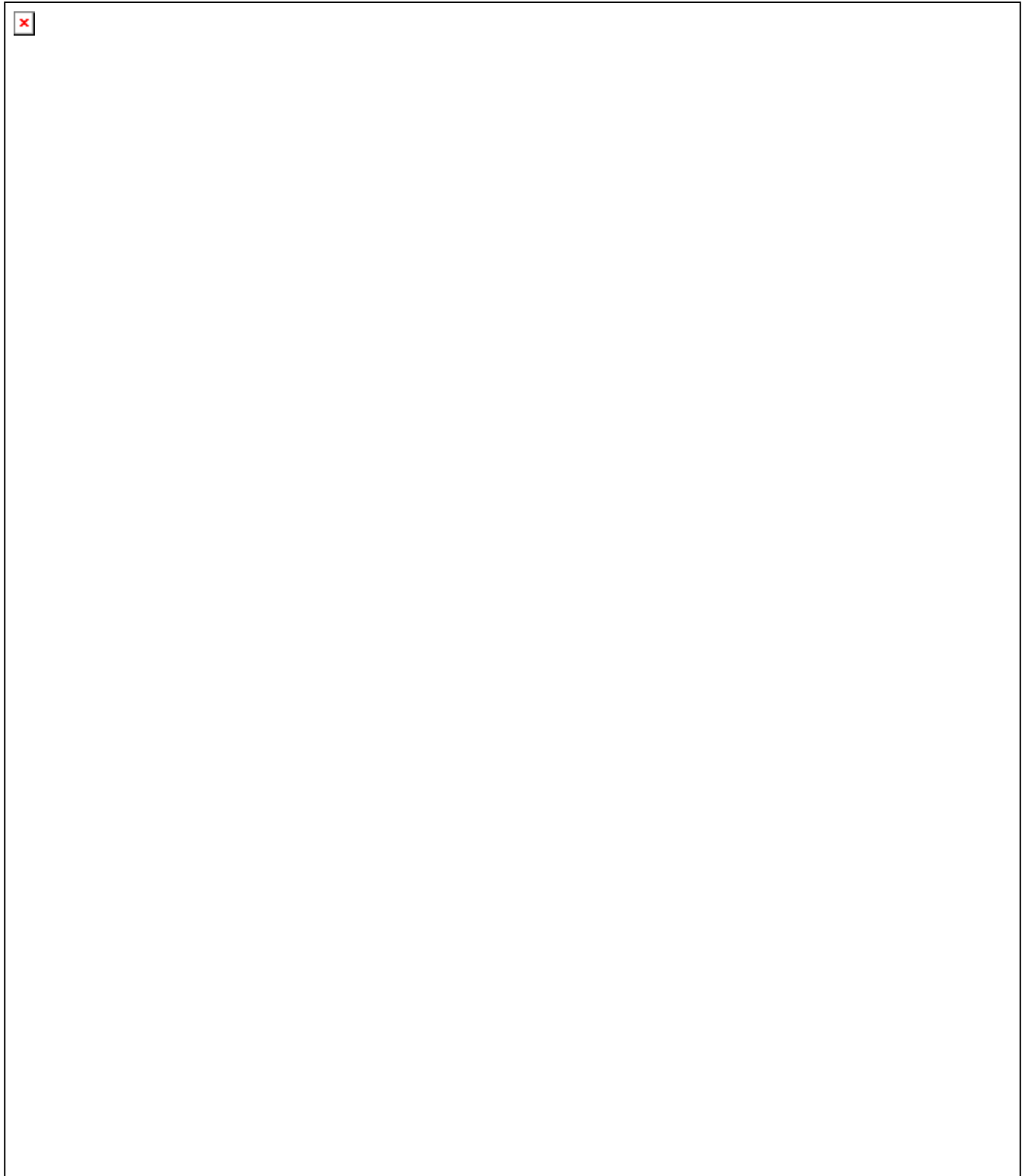

EVB TEST RESULTS (continued)

Performance waveforms are tested on the evaluation board.

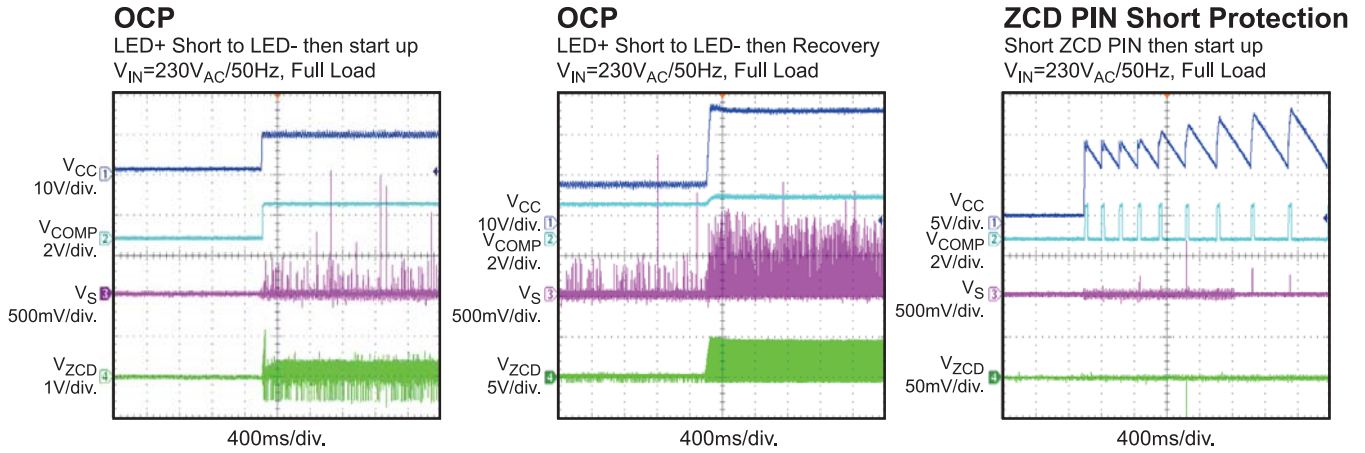
 $V_{IN}=230V_{AC}/50Hz$, 8 LEDs in series, $I_{LED}=420mA$, $V_{OUT}=24V$, $L_P=3.4mH$, $N_P:N_S:N_{AUX} = 132:24:25$.

QUICK START GUIDE

1. Preset AC Power Supply to $198\text{VAC} \leq V_{\text{IN}} \leq 265\text{VAC}$.
2. Turn Power Supply off.
3. Connect the LED string between “LED+” (anode of LED string) and “LED-” (cathode of LED string).
4. Connect Power Supply terminals to AC V_{IN} terminals as shown on the board.
5. Turn AC Power Supply on after making connections.