



The Future of Analog IC Technology®

# EV4032-1-S-00A

108V<sub>AC</sub> to 132V<sub>AC</sub>/60Hz, 18V<sub>OUT</sub>/350mA

Primary-Side-Control with Active PFC

Off-Line Dimmable LED Driver Evaluation Board

## DESCRIPTION

The EV4032-1-S-00A Evaluation Board is designed to demonstrate the capabilities of MP4032-1. The MP4032-1 is a TRIAC-dimmable, primary-side-controlled, offline, LED lighting driver with an integrated 500V MOSFET. It can achieve a high power factor and accurate LED current control for lighting applications in a single-stage converter. It works in boundary conduction mode for reducing the MOSFET and Diode switching losses.

The EV4032-1-S-00A is typically designed for driving a 6.5W Triac dimmable LED bulb with 18V<sub>TYP</sub>, 350mA LED load from 108V<sub>AC</sub> to 132V<sub>AC</sub>, 60Hz.

The EV4032-1-S-00A has an excellent efficiency and meets IEC61547 surge immunity, IEC61000-3-2 Class C harmonics and EN55015 conducted EMI requirements. It has multi-protection function as over-voltage protection, short-circuit protection, cycle by cycle current limit, etc.

## ELECTRICAL SPECIFICATION

| Parameter              | Symbol           | Value      | Units           |
|------------------------|------------------|------------|-----------------|
| Input Voltage          | V <sub>IN</sub>  | 108 to 132 | V <sub>AC</sub> |
| Output Voltage         | V <sub>OUT</sub> | 18         | V               |
| LED Current            | I <sub>LED</sub> | 350        | mA              |
| Output Power           | P <sub>OUT</sub> | 6.5        | W               |
| Efficiency (Full Load) | η                | >82        | %               |
| Power Factor           | PF               | >0.95      |                 |
| THD                    | THD              | <15        | %               |

## FEATURES

- Fast Start Up
- Triac Dimmable, with 1% to 100% Dimming Range and the Dimming Curve Meets Standard SSL6
- Real Current Control without Secondary-Feedback Circuit
- Internal MOSFET with 500V High Voltage Rating
- Unique Architecture for Superior Line Regulation
- High Power Factor >0.95 over 108V<sub>AC</sub> to 132V<sub>AC</sub>
- Boundary Conduction Mode Improves Efficiency
- Input UVLO
- Cycle-by-Cycle Current Limit
- Over-Voltage Protection (OVP)
- Short-Circuit Protection (SCP)
- Over-Temperature Protection (OTP)

## APPLICATIONS

- Solid State Lighting
- Industrial & Commercial Lighting
- Residential Lighting

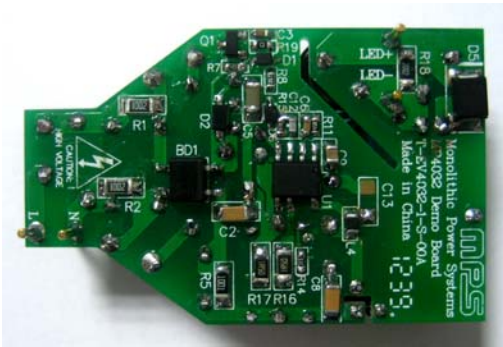
All MPS parts are lead-free and adhere to the RoHS directive. For MPS green status, please visit MPS website under Quality Assurance. "MPS" and "The Future of Analog IC Technology", are Registered Trademarks of Monolithic Power Systems, Inc.



High Voltage

**Warning:** Although this board is designed to satisfy safety requirements, the engineering prototype has not been agency approved. Therefore, all testing should be performed using an isolation transformer to provide the AC input to the prototype board.

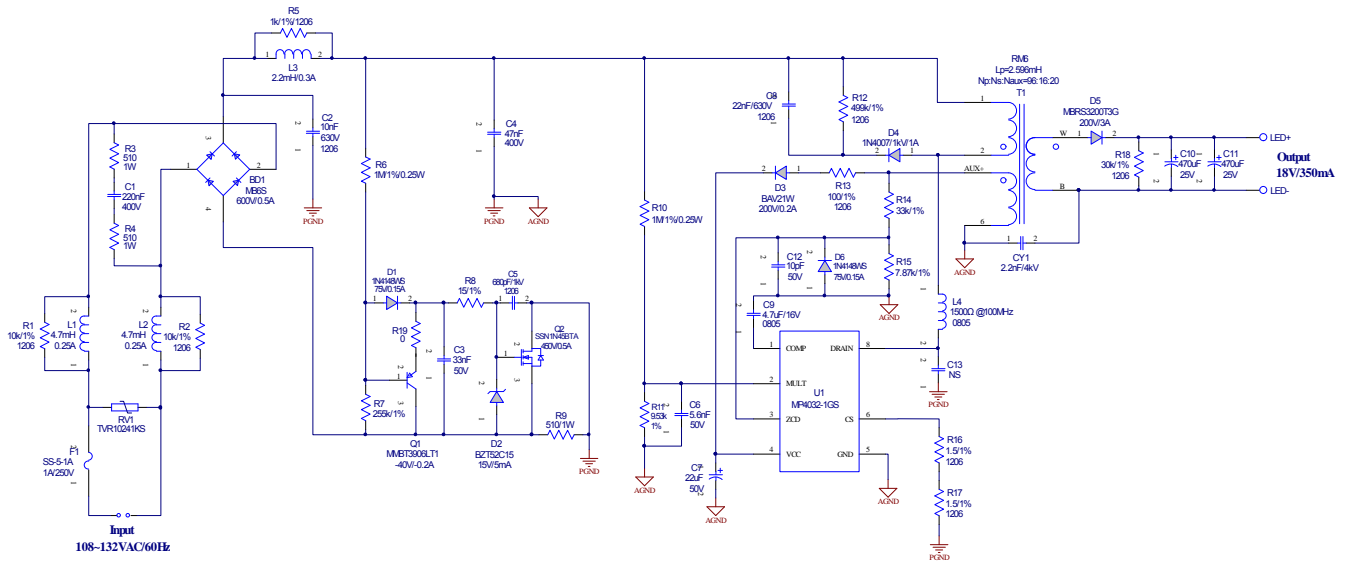
**EV4032-1-S-00A EVALUATION BOARD**



(L x W x H) 50mm x 32mm x 15mm

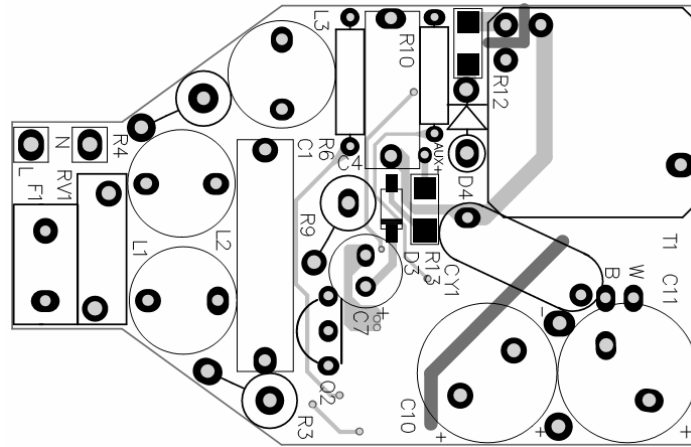
| Board Number   | MPS IC Number |
|----------------|---------------|
| EV4032-1-S-00A | MP4032-1      |

**EVALUATION BOARD SCHEMATIC**

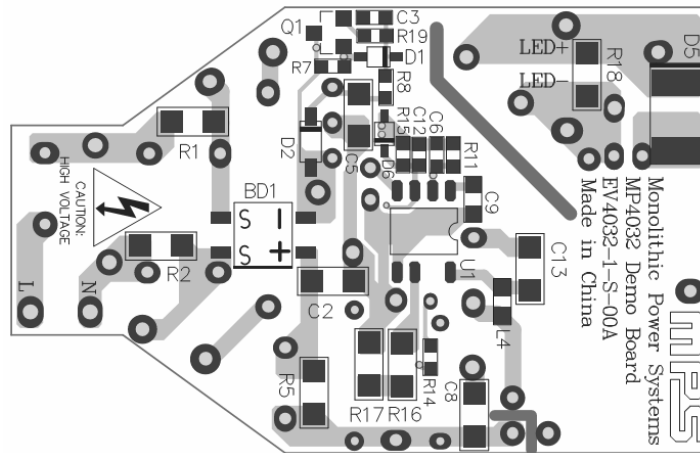


**Figure 1—Schematic**

**PCB LAYOUT (SINGLE-SIDED)**



**Figure 2—Top Layer**



**Figure 3—Bottom Layer**

## CIRCUIT DESCRIPTION

The EV4032-1-S-00A is configured in a single-stage Flyback topology, it uses primary-side-control which can mostly simplify the schematic and get a cost effective BOM. It can also achieve high power factor and accurate LED current.

F1, RV1, L1, L2, R1, R2, BD1, C2, L3, R5 and C4 compose the input stage. F1 fuses the AC input to protect for the component failure or some excessive short events. RV1 is used for surge test. L1, L2, R1, R2, C2, L3, R5 and C4 associated with CY1 form the EMI filter which can meet the standard EN55015. The diode rectifier BD1 rectifies the input line voltage. Small bulk CBB capacitor C4 is used for a low impedance path for the primary switching current, to maintain high power factor, the capacitance of C4 should be selected with low value.

R6, R7, R8, C3, C5, D1, D2, Q1, Q2 with R9 compose the damping circuit for reducing the inrush current at the dimmer turning on time. The circuit let the inrush current flow through R9 at first when triac dimmer turns on. Then Q2 turns on and shorts R9, this can save power from R9. Q1 is used to discharge C3 when the triac is off. D2 is used to clamp the gate voltage of Q2 to 15V.

R3, R4, C1 are used as a bleeder circuit which keeping the triac current above the minimum holding current after triac turns on.

R10, R11, C6 provide sine wave reference for the primary peak current to get an active PFC function. The divided voltage should be lower than the max voltage rating of MULT pin.

R13, D3, C7 are used to supply the power for MP4032-1. A 22 $\mu$ F bulk capacitor C7 is selected to maintain the supply voltage. At start-up, C7 is first charged up from the DRAIN pin through an internal high-voltage DRAIN charger. Once the VCC voltage reaches 13.8V, the control logic initiates and the gate drive signal forces the integrated high-voltage power MOSFET to begin switching for normal operation. Meanwhile, the DRAIN charger stops, and the power supply is taken over by the auxiliary winding through R13, D3.

R14, R15 are used to detect the auxiliary winding to get the transformer magnetizing current zero crossing signal for realizing the boundary conduction operation, and also monitor the output OVP condition. The OVP voltage is set by the divider ratio of R14, R15. C12 is used to restrain the oscillation caused by the leakage inductor and the parasitical capacitor to avoid mis-triggering OVP. D6 is used to clamp the negative voltage on ZCD Pin when switch on.

R16, R17 are primary sensing resistors for primary side current control. The value of R16, R17 set the output LED current. C8, R12, D4 are used to damp the leakage inductance energy so the drain voltage can be suppressed at a safe level.

Diode D5 rectifies the secondary winding voltage and the capacitor C10, C11 are the output filter. The resistor R18 is placed as pre-load to limit the output voltage rise too high in open load condition.

**EV4032-1-S-00A BILL OF MATERIALS**

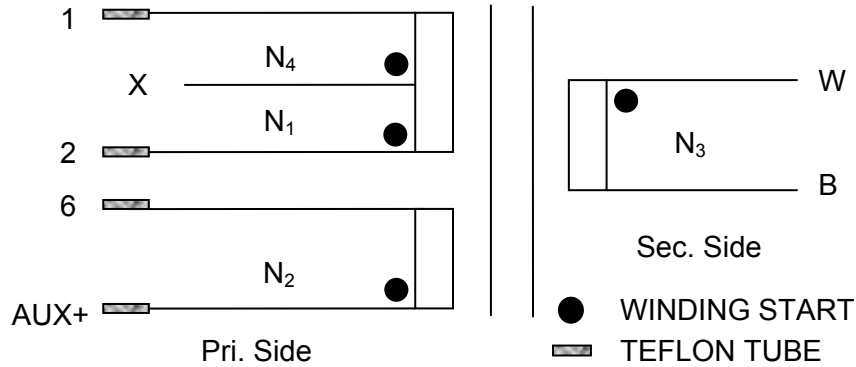
| Qty | Ref         | Value            | Description                                     | Package | Manufacturer         | Manufacturer_P/N    |
|-----|-------------|------------------|---|---------|----------------------|---------------------|
| 1   | BD1         | MB6S             | Diode;600V;0.5A;                                | SOIC-4  | TaiWan Semiconductor | MB6S                |
| 1   | C1          | 220nF            | Capacitor;400V;CBB                              | DIP     | Panasonic            | ECQE4224KF          |
| 1   | C2          | 10nF             | Ceramic Capacitor;<br>630V;X7R;1206;            | 1206    | TDK                  | C3216X7R2J103K      |
| 1   | C3          | 33nF             | Ceramic Capacitor;<br>50V;X7R;0603;             | 0603    | muRata               | GRM188R71H333KA61D  |
| 1   | C4          | 47nF             | Capacitor;400V;CBB                              | DIP     | Panasonic            | ECQE4473KF          |
| 1   | C5          | 680pF            | Ceramic Capacitor;<br>1000V;U2J;1206;           | 1206    | muRata               | GRM31B7U3A681JW31L  |
| 1   | C6          | 5.6nF            | Ceramic Capacitor;<br>50V;X7R;0603;             | 0603    | muRata               | GRM188R71H562KA01D  |
| 1   | C7          | 22uF             | Electrolytic Capacitor;<br>50V;Electrolytic;DIP | DIP     | Jianghai             | CD281L-50V22        |
| 1   | C8          | 22nF             | Ceramic Capacitor;<br>630V;X7R;1206             | 1206    | TDK                  | C3216X7R2J223K      |
| 1   | C9          | 4.7uF            | Ceramic Capacitor;<br>16V;X7R;0805              | 0805    | muRata               | GRM21BR71C475KA73L  |
| 2   | C10,<br>C11 | 470uF            | Electrolytic Capacitor;<br>25V;Electrolytic     | DIP     | Rubycon              | 25ZLF470MEFC10X12.5 |
| 1   | C12         | 10pF             | Ceramic Capacitor;<br>50V;C0G;0603;             | 0603    | TDK                  | C1608COG1H100D      |
| 1   | C13         | NS               |   |         |                      |                     |
| 1   | CY1         | 2.2nF            | Capacitor;4000V;20%                             | DIP     | Hongke               | JNK12E222MY02N      |
| 2   | D1,<br>D6   | 1N4148WS         | Diode;75V;0.15A;                                | SOD-323 | Diodes               | 1N4148WS-7-F        |
| 1   | D2          | BZT52C15         | Zener Diode;<br>15V;5mA/500mW;                  | SOD-123 | Diodes               | BZT52C15            |
| 1   | D3          | BAV21W           | Diode;200V;0.2A;                                | SOD-123 | Diodes               | BAV21W-7-F          |
| 1   | D4          | 1N4007           | Diode;1000V;1A                                  | DO-41   | Diodes               | 1N4007              |
| 1   | D5          | MBRS3200<br>T3G  | Diode;200V;3A;                                  | SMB     | ON                   | MBRS3200T3G         |
| 1   | F1          | SS-5-1A          | Fuse;250V;1A                                    | DIP     | COOPER<br>BUSSMANN   | SS-5-1A             |
| 2   | L1,<br>L2   | 4.7mH            | Inductor;<br>4.7mH;9.5;250mA                    | DIP     | Würth                | 744772472           |
| 1   | L3          | 2.2mH            | Inductor;<br>2200uH;4.73 Ohm;0.3A               | DIP     | Würth                | 7447720222          |
| 1   | L4          | 1500Ω<br>@100MHz | Magnetic Bead;<br>1500Ω @100MHz;<br>0.3Ω, 100mA | 0805    | Würth                | 742792097           |

**EV4032-1-S-00A BILL OF MATERIALS (continued)**

| Qty | Ref              | Value           | Description                                 | Package  | Manufacturer        | Manufacturer_P/N |
|-----|------------------|-----------------|---|----------|---------------------|------------------|
| 1   | Q1               | MMBT3906L<br>T1 | Transistor;-40V;-0.2A;                      | SOT-23   | ON<br>Semiconductor | MMBT3906LT1      |
| 1   | Q2               | SSN1N45BT<br>A  | Mosfet;450V;0.5A                            | TO-92    | Fairchild           | SSN1N45BTA       |
| 2   | R1,<br>R2        | 10kΩ            | Film Resistor;1%                            | 1206     | Yageo               | RC1206FR-0710K   |
| 3   | R3,<br>R4,<br>R9 | 510Ω            | Resistor;5%;1W                              | DIP      | any                 | any              |
| 1   | R5               | 1kΩ             | Resistor;1%                                 | 1206     | Hottechohm          | RI1206L1001FT    |
| 2   | R6,<br>R10       | 1MΩ             | Resistor;1%;1/4W                            | DIP      | any                 | any              |
| 1   | R7               | 255kΩ           | Film Resistor;1%                            | 0603     | Yageo               | RC0603FR-07255KL |
| 1   | R8               | 15Ω             | Film Resistor;1%                            | 0603     | Yageo               | RC0603FR-0715RL  |
| 1   | R11              | 9.53kΩ          | Film Resistor;1%                            | 0603     | Yageo               | RC0603FR-079K53L |
| 1   | R12              | 499kΩ           | Film Resistor;1%;                           | 1206     | Yageo               | RC1206FR-07499KL |
| 1   | R13              | 100Ω            | Resistor;1%;1/4W                            | 1206     | Yageo               | RC1206FR-07100RL |
| 1   | R14              | 33kΩ            | Film Resistor;1%;                           | 0603     | Yageo               | RC0603FR-0733KL  |
| 1   | R15              | 7.87kΩ          | Film Resistor;1%                            | 0603     | Yageo               | RC0603FR-077K87L |
| 2   | R16,<br>R17      | 1.5Ω            | Resistor;1%                                 | 1206     | Royalohm            | 1206F150KT5E     |
| 1   | R18              | 30kΩ            | Resistor;1%                                 | 1206     | Yageo               | RC1206FR-0730KL  |
| 1   | R19              | 0               | Film Resistor;5%;                           | 0603     | Yageo               | RC0603JR-070RL   |
| 1   | RV1              | TVR10241K<br>S  | Metal Oxide Varistor;<br>10mm; 240V; 4000A  | DIP      | TKS                 | TVR10241KS       |
| 1   | T1               | FX0281          | RM6; Lp=2.596mH;<br>Np:Ns:Naux=96:16:2<br>0 | RM6      | Emei                | RM6P6M2.6-00     |
| 1   | U1               | MP4032-1        | Offline LED Lighting<br>Driver              | SOIC8-7A | MPS                 | MP4032-1GS-Z     |

## TRANSFORMER SPECIFICATION

### Electrical Diagram

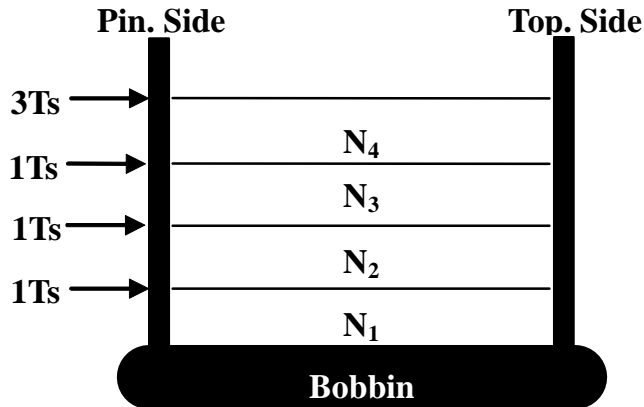


**Figure 4—Transformer Electrical Diagram**

### Notes:

1. Don't connect X to any pin of Bobbin.
2. Don't connect AUX+, W and B to any pin of Bobbin, add black Teflon tube to B, white tube to W.

### Winding Diagram



**Figure 5—Winding Diagram**

**Winding Order**

| Tape Layer Number | Winding No     | Start & End | Magnet Wire $\Phi$ (mm) | Turns |
|-------------------|----------------|-------------|-------------------------|-------|
| 1                 | N <sub>1</sub> | 2—> X       | 0.18*1                  | 48    |
| 1                 | N <sub>2</sub> | AUX+—> 6    | 0.15*1                  | 20    |
| 1                 | N <sub>3</sub> | W—> B       | 0.35*1(T.I.W)           | 16    |
| 3                 | N <sub>4</sub> | X—> 1       | 0.18*1                  | 48    |

**Electrical Specifications**

| Item                                 | Measurements          | Characteristics       | Test Conditions<br>T=25±4°C;<br>HR(%)=45±15 | REMARK                        |
|--------------------------------------|-----------------------|-----------------------|---|-------------------------------|
| Primary Inductance (L <sub>p</sub> ) | PIN(2-1)              | 2.596mH±8%            | f(KHz)=70<br>U <sub>g</sub> (V)=0.25        | SERIAL MODE                   |
| DCR                                  | PIN(2-1)              | 3.0Ω MAX.             | /   | 4 WIRES MODE                  |
| Turn Ratio                           | (2-1):(AUX-6):(W-B)   | 96Ts:20Ts:16Ts±0.5Ts  | f(KHz)=20<br>U <sub>g</sub> (V)=1           | U <sub>g</sub> apply pin(2-1) |
| Electrical Strength                  | Pri. Side ~ Sec. Side | NO BREAKDOWN (≤1.0mA) | V <sub>AC</sub> =3500V                      | 1SEC.<br>F(Hz)=60             |
|                                      | Pri. Side ~ Core      | NO BREAKDOWN (≤1.0mA) | V <sub>AC</sub> =2000V                      |                               |
|                                      | Sec. Side ~ Core      | NO BREAKDOWN (≤1.0mA) | V <sub>AC</sub> =2000V                      |                               |

**Materials**

| Item | Description   |
|------|---|
| 1    | Core: RM6, UI=2500±25%, AL=184.5H/N <sup>2</sup> ±3% GAP, ACME P4 or equivalent |
| 2    | Bobbin: RM6, 3+3PIN RMMOVE PIN6 1SECT TH, PM9630 UL94V-0                        |
| 3    | Wire: $\Phi$ 0.15 & 0.18mm, 2UEW, CLASS B or equivalent                         |
| 4    | Triple Insulation Wire: $\Phi$ 0.35mm, TRW(B) or equivalent                     |
| 5    | Tape: 6.5mm(W)×0.06mm(TH)   |
| 6    | Tape: 3.5mm(W)×0.06mm(TH)   |
| 7    | Varnish: JOHN C. DOLPH CO, BC-346A or equivalent                                |
| 8    | Adhesive: 400-36 or equivalent  |
| 9    | Solder Bar: CHEN NAN: SN99.5/Cu0.5 or equivalent                                |



## EVB TEST RESULTS

### Performance Data

#### Efficiency, PF and THD

| $f$<br>(Hz) | $V_{IN}$<br>(V <sub>AC</sub> ) | $I_{IN}$<br>(mA) | $P_{IN}$<br>(W) | $V_{OUT}$<br>(V) | $I_{OUT}$<br>(mA) | $P_{OUT}$<br>(W) | Efficiency<br>(%) | PF    | THD<br>(%) |
|-------------|--------------------------------|------------------|-----------------|------------------|-------------------|------------------|-------------------|-------|------------|
| 60          | 108                            | 74               | 7.97            | 18.46            | 354.5             | 6.544            | 82.11             | 0.991 | 8.9        |
|             | 110                            | 72               | 7.92            | 18.44            | 353.6             | 6.520            | 82.33             | 0.990 | 8.9        |
|             | 115                            | 69               | 7.86            | 18.43            | 353.3             | 6.511            | 82.84             | 0.987 | 9.0        |
|             | 120                            | 66               | 7.81            | 18.42            | 353.3             | 6.508            | 83.33             | 0.984 | 9.1        |
|             | 125                            | 63               | 7.79            | 18.42            | 353.4             | 6.510            | 83.56             | 0.981 | 9.2        |
|             | 130                            | 61               | 7.76            | 18.41            | 353.4             | 6.506            | 83.84             | 0.977 | 9.2        |
|             | 132                            | 60               | 7.75            | 18.41            | 353.3             | 6.504            | 83.93             | 0.975 | 9.2        |

#### Dimming Compatibility (No Flicker with these 27 different Dimmers)

| Manufacturer | Part No.       | Power Stage | $I_{MAX}$ (mA) | $I_{MIN}$ (mA) | Dimming Ratio | Min Start Current (mA) |
|--------------|----------------|-------------|----------------|----------------|---------------|------------------------|
| LUTRON       | 6B38-DVLV-600P | 600W        | 333            | 6              | 1.80%         | 6                      |
| LUTRON       | 6B38-DV-603PG  | 600W        | 241            | 5              | 2.07%         | 5                      |
| LUTRON       | 6B38-S-600P    | 600W        | 330            | 1              | 0.30%         | 1                      |
| LUTRON       | 6B38-S-603PG   | 600W        | 246            | 2              | 0.81%         | 2                      |
| LUTRON       | S-600          | 600W        | 357            | 1              | 0.28%         | 1                      |
| LUTRON       | SLV-600P       | 600W        | 341            | 6              | 1.76%         | 6                      |
| LUTRON       | 6B38-GL-600-IV | 600W        | 356            | 8              | 2.25%         | 8                      |
| LUTRON       | NTLV-600-AL    | 600W        | 355            | 6              | 1.69%         | 6                      |
| LUTRON       | AY-600P        | 600W        | 342            | 8              | 2.34%         | 8                      |
| LUTRON       | TG-603GH-WH    | 600W        | 221            | 9              | 4.07%         | 9                      |
| LUTRON       | TG-600PH-WH    | 600W        | 341            | 11             | 3.23%         | 11                     |
| LUTRON       | CN-600P        | 600W        | 334            | 5              | 1.50%         | 5                      |
| LEVITON      | RPI06          | 600W        | 357            | 0              | 0.00%         | 11                     |
| LEVITON      | 6633-P-1G1005  | 600W        | 357            | 0              | 0.00%         | 1                      |
| LUTRON       | 6B38-Q-600P    | 600W        | 341            | 9              | 2.64%         | 9                      |
| LUTRON       | 6B38-DV-600P   | 600W        | 329            | 2              | 0.61%         | 2                      |
| COOPER       | 6B28           | 600W        | 357            | 0              | 0.00%         | 10                     |
| LUTRON       | LG-600P        | 600W        | 337            | 3              | 0.89%         | 3                      |
| LEVITON      | 1G4005         | 600W        | 347            | 0              | 0.00%         | 4                      |
| LEVITON      | 6615-P0W       | 300W        | 355            | 54             | 15.21%        | 54                     |
| LEVITON      | C20-6684-IW    | 600W        | 356            | 0              | 0.00%         | 5                      |
| LUTRON       | DVELV-303P-WH  | 300W        | 355            | 8              | 2.25%         | 8                      |
| LUTRON       | DV-600P-BR     | 600W        | 333            | 3              | 0.90%         | 3                      |
| LUTRON       | DVPDC-203P-WH  | 200W        | 355            | 50             | 14.08%        | 50                     |
| LUTRON       | MAELV-600-WH   | 600W        | 344            | 0              | 0.00%         | 13                     |
| LUTRON       | AY-600P-LA     | 600W        | 350            | 13             | 3.71%         | 13                     |
| LUTRON       | GL-600H-DK     | 600W        | 355            | 2              | 0.56%         | 2                      |

**Electric Strength Test**

Primary circuit to secondary circuit electric strength testing was completed according to IEC61347-1 and IEC61347-2-13.

Input and output was shorted respectively. 3750V<sub>AC</sub>/50Hz sine wave applied between input and output for 1min, and operation was verified.

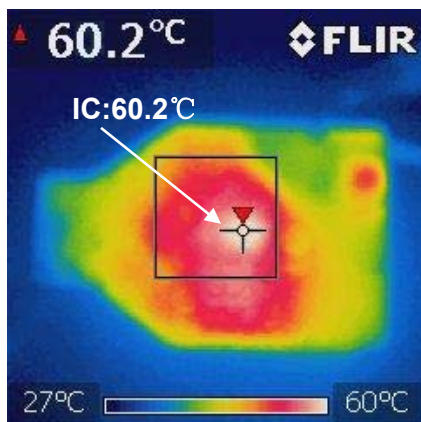
**Surge Test**

Line to Line 1kV surge testing was completed according to IEC61547.

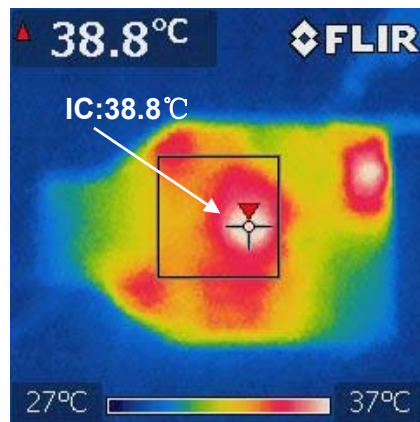
Input voltage was set at 110V<sub>AC</sub>/60Hz. Output was loaded at full load and operation was verified following each surge event.

| Surge Level (V) | Input Voltage (V <sub>AC</sub> ) | Injection Location | Injection Phase (°) | Test Result (Pass/Fail) |
|-----------------|----------------------------------|--------------------|---------------------|-------------------------|
| +1000           | 110                              | L to N             | 0                   | Pass                    |
| -1000           | 110                              | L to N             | 0                   | Pass                    |
| +1000           | 110                              | L to N             | 90                  | Pass                    |
| -1000           | 110                              | L to N             | 270                 | Pass                    |

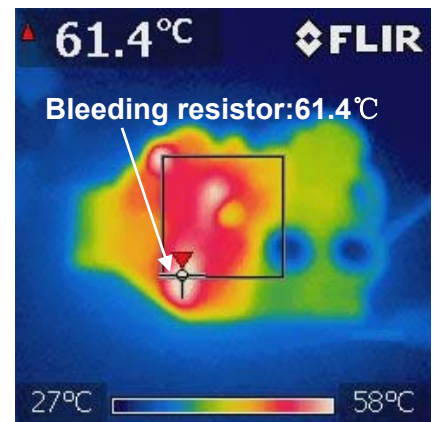
**Thermal Test**



Without dimmer @ V<sub>IN</sub>=108V<sub>AC</sub>



Output short without dimmer @ V<sub>IN</sub> =132V<sub>AC</sub>



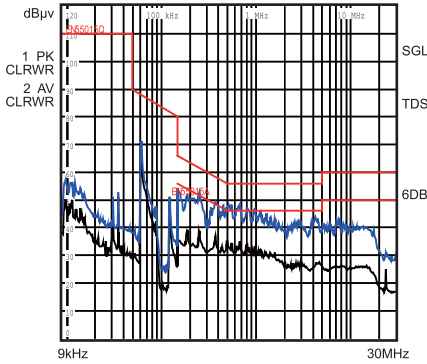
50% dimming @ Vin=120V<sub>AC</sub>

## EVB TEST RESULTS

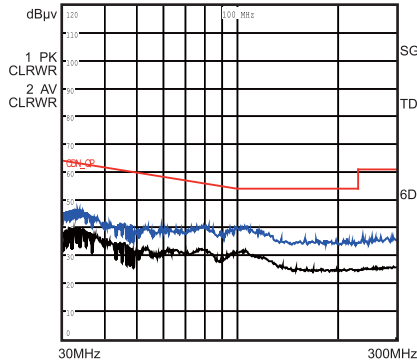
Performance waveforms are tested on the evaluation board.

$V_{IN}=120V_{AC}/60Hz$ , 6 LEDs in series,  $I_{LED}=350mA$ ,  $V_{OUT}=18V$ ,  $L_P=2.6mH$ ,  $N_P:N_S:N_{AUX}=96:16:20$

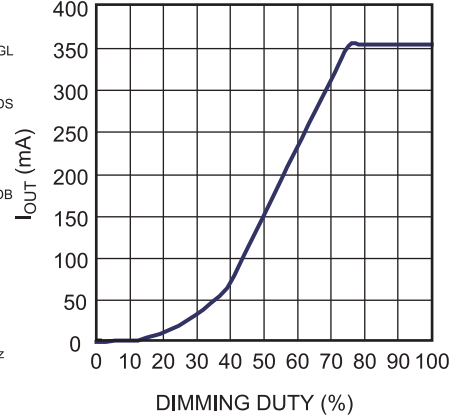
**Conducted EMI**



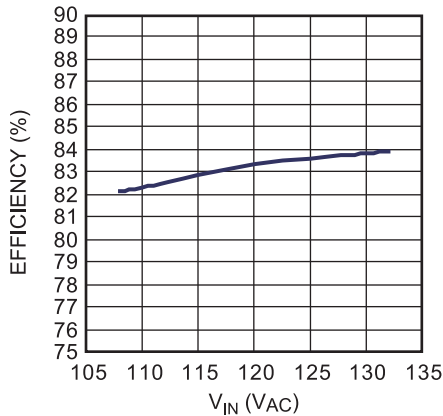
**CDN**



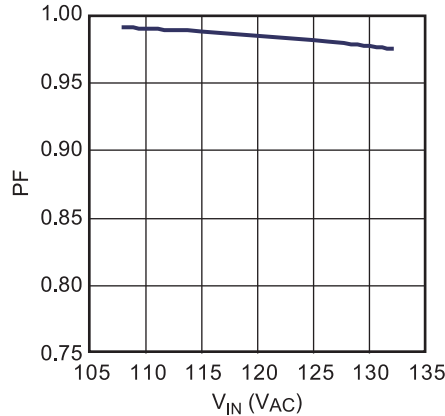
**Dimming Curve**



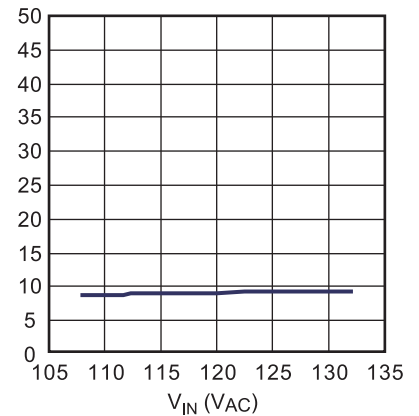
**Efficiency vs.  $V_{IN}$**



**PF vs.  $V_{IN}$**



**THD vs.  $V_{IN}$**

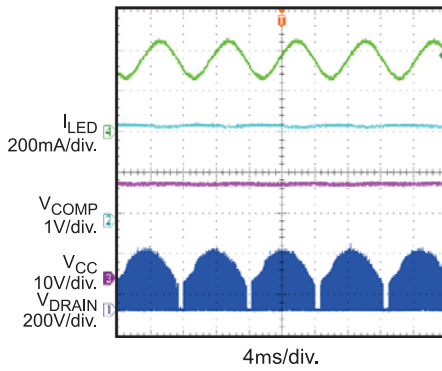


**EVB TEST RESULTS** *(continued)*

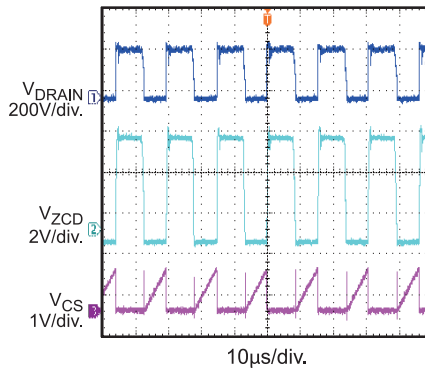
Performance waveforms are tested on the evaluation board.

$V_{IN}=120V_{AC}/60Hz$ , 6 LEDs in series,  $I_{LED}=350mA$ ,  $V_{OUT}=18V$ ,  $L_P=2.6mH$ ,  $N_P:N_S:N_{AUX}=96:16:20$

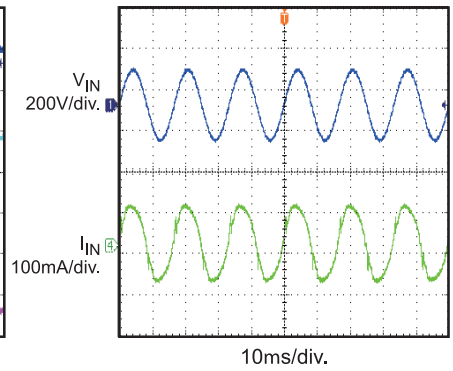
Steady State



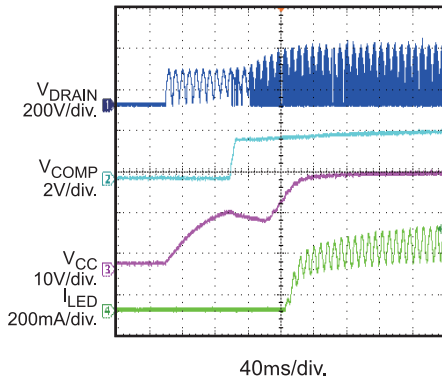
Steady State



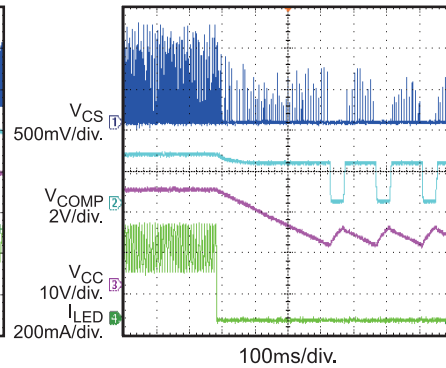
Steady State



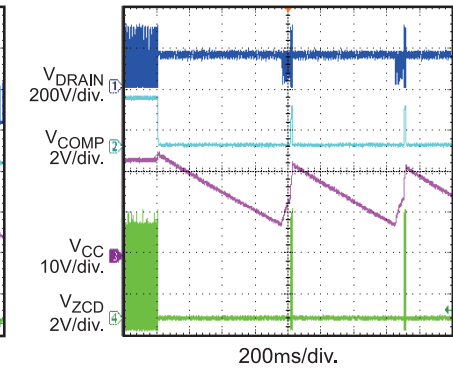
$V_{IN}$  Start-Up



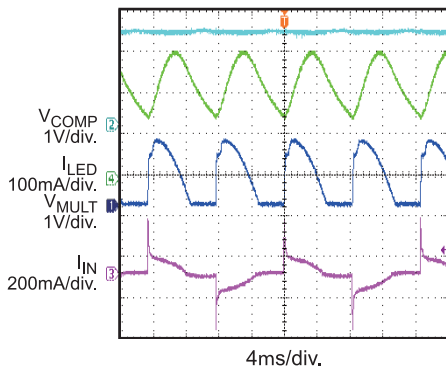
Short Circuit Protection  
LED+ Short to LED- When Working



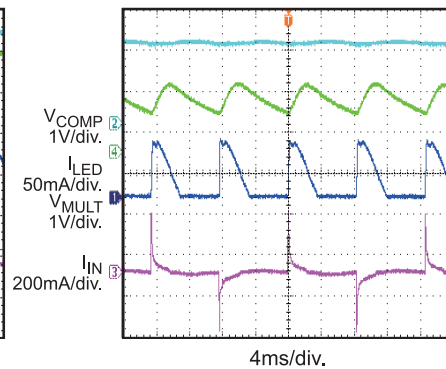
Over Voltage Protection  
LED Load Open When Working



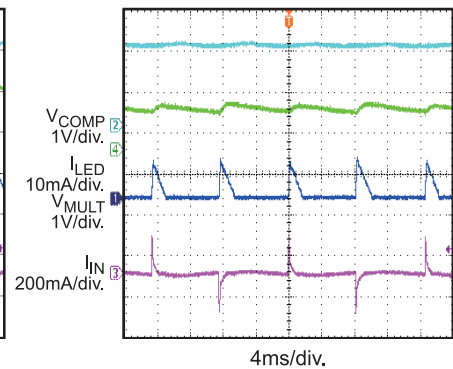
Triac Dimming  
Duty=60%



Triac Dimming  
Duty=40%



Triac Dimming  
Duty=20%



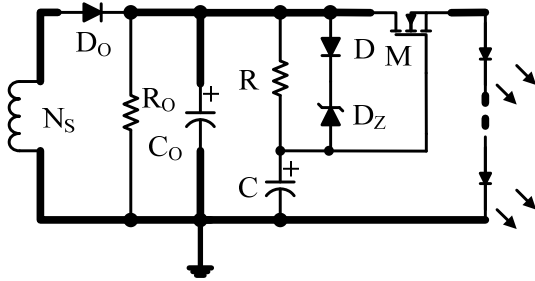
## QUICK START GUIDE

1. Preset AC Power Supply to  $108V_{AC} \leq V_{IN} \leq 132V_{AC}$ .
2. Turn Power Supply off.
3. Connect the LED string between “LED+” (anode of LED string) and “LED-” (cathode of LED string).
4. Connect Power Supply terminals to AC  $V_{IN}$  terminals as shown on the board.
5. Turn AC Power Supply on after making connections.
6. For Triac dimming LED lighting application, especially in deep dimming situation, the LED would shimmer caused by the dimming on duty which is not all the same in every line cycle. What's more, the Grid has noise or inrush which would bring out shimmer even flicker. The suppressor circuit would help to improve this. For detailed information please refer to appendix.

**APPENDIX**  
**RIPPLE SUPPRESSOR**

(Innovative Proprietary)

For dimming LED lighting application, a single stage PFC converter needs large output capacitor to reduce the ripple whose frequency is double of the Grid. And in deep dimming situation, the LED would have shimmer caused by the dimming on duty which is not all the same in every line cycle. What’s more, the Grid has noise or inrush which would bring out shimmer even flicker. Figure 9 shows a ripple suppressor, which can shrink the LED current ripple obviously.



**Figure6—Ripple Suppressor**

**Principle**

Shown in Figure 6, Resistor R, capacitor C, and MOSFET M compose the ripple suppressor. Through the RC filter, C gets the mean value of the output voltage  $V_{Co}$  to drive the MOSFET M. M works in variable resistance area. C’s voltage  $V_C$  is steady makes the LEDs voltage is steady, so the LEDs current will be smooth. MOSFET M holds the ripple voltage  $v_{Co}$  of the output.

Diode D and Zener diode  $D_Z$  are used to restrain the overshoot at start-up. In the start-up process, through D and  $D_Z$ , C is charged up quickly to turn on M, so the LED current can be built quickly. When  $V_C$  rising up to about the steady value, D and  $D_Z$  turn off, and C combines R as the filter to get the mean voltage drop of  $V_{Co}$ .

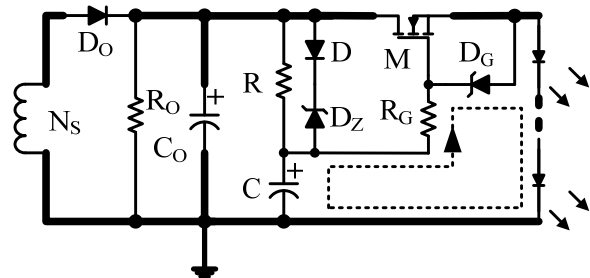
The most important parameter of MOSFET M is the threshold voltage  $V_{th}$  which decides the power loss of the ripple suppressor. Lower  $V_{th}$  is better if the MOSFET can work in variable resistance area. The BV of the MOSFET can be selected as double as  $V_{Co}$  and the Continuous Drain current level can be selected as decuple as the LEDs’ current at least.

About the RC filter, it can be selected by  $\tau_{RC} \geq 50/f_{LineCycle}$ . Diode D can select 1N4148, and the Zener voltage of  $D_Z$  is as small as possible when guarantee  $V_D + V_{DZ} > 0.5 \cdot V_{Co\_PP}$ .

**Optional Protection Circuit**

In large output voltage or large LEDs current application, MOSFET M may be destroyed by over-voltage or over-current when LED+ shorted to LED- at working.

**Gate-Source(GS) Over-voltage Protection**



**Figure 7—Gate-Source OVP Circuit**

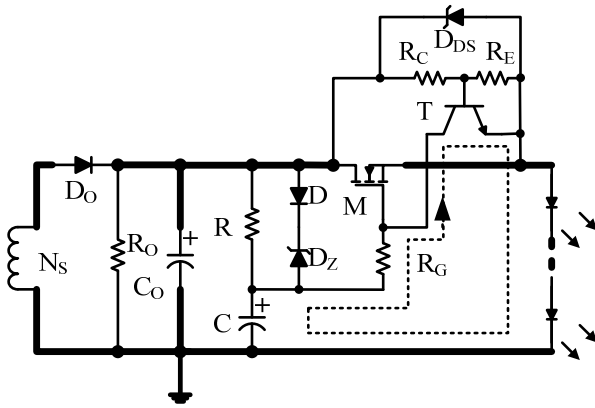
Figure 7 shows GS over-voltage protection circuit. Zener diode  $D_G$  and resistor  $R_G$  are used to protect MOSFET M from GS over-voltage damaged. When LED+ shorted to LED- at normal operation, the voltage drop on capacitor C is high, and the voltage drop on Gate-Source is the same as capacitor C. The Zener diode  $D_G$  limits the voltage  $V_{GS}$  and  $R_G$  limits the charging current to protect  $D_G$ .  $R_G$  also can limit the current of  $D_Z$  at the moment when LED+ shorted to LED-.  $V_{DG}$  should bigger than  $V_{th}$ .

**Drain-Source Over-voltage and Over-current Protection**

As Figure 8 shows, NPN transistor T, resistor  $R_C$  and  $R_E$  are set up to protect MOSFET M from over-current damaged when output short occurs at normal operation. When LED+ shorted to LED-, the voltage  $v_{DS}$  of MOSFET is equal to the  $v_{Co}$  which has a high surge caused by the parasitic parameter. Zener Diode  $D_{DS}$  protects MOSFET

from over-voltage damaged. Transistor T is used to pull down the  $V_{GS}$  of M. When M turns off, the load is opened, then the OVP mode is triggered, and the IC functions in quiescent. The pull down point is set by  $R_C$  and  $R_E$ :

$$R_C/R_E \cdot \frac{V_{CO}}{2} = 0.7V.$$



**Figure 8—Drain-Source OVP and OCP Circuit**

**MOSFET LIST**

In the Table 1, there are some recommended MOSFET for ripple suppressor.

**Table 1: MOSFET LIST**

| Manufacture P/N | Manufacture | $V_{DS}/I_D$ | $V_{th}(V_{DS}=V_{GS}@T_J=25^{\circ}C)$ | Package | Power Stage |
|-----------------|-------------|--------------|---|---------|-------------|
| Si4446DY        | Vishay      | 40V/3A       | 0.6-1.6V@ $I_D=250\mu A$                | SO-8    | <10W        |
| FTD100N10A      | IPS         | 100V/17A     | 1.0-2.0V@ $I_D=250\mu A$                | TO-252  | 5-15W       |
| P6015CDG        | NIKO-SEM    | 150V/20A     | 0.45-1.20V@ $I_D=250\mu A$              | TO-252  | 10-20W      |

**NOTICE:** The information in this document is subject to change without notice. Please contact MPS for current specifications. Users should warrant and guarantee that third party Intellectual Property rights are not infringed upon when integrating MPS products into any application. MPS will not assume any legal responsibility for any said applications.