



The Future of Analog IC Technology®

EV4008-S-00A

High-Brightness High-Current Accuracy WLED Controller

DESCRIPTION

The EV4008-S-00A is designed to demonstrate the capabilities of MP4008. The MP4008 is a current mode controller designed for driving the high brightness Light Emitting Diodes (LEDs) with wide input voltage 9V-28V. It can be used both in Boost and SEPIC topologies.

With a 20-48V power supply PVIN and a 9-28V IC supply for MP4008, The evaluation board can drive a single LED string with the LED current regulated to 350mA and VLED voltage up to 70V. Apply a PWM dimming signal to do PWM dimming. The Over-Voltage protection, short LED protection, short inductor/diode protection and over current protection are integrated.

ELECTRICAL SPECIFICATION

Parameter	Symbol	Value	Units
Power Supply Voltage	PVIN	20-48	V
IC Supply Voltage	VIN	9-28	V
LED Voltage	V _{LED}	70(max)	V
LED Current	I _{LED}	350	mA
Switching Frequency	fs	180	kHz
Over Voltage Protection Point	V _{OV} P	81	V

FEATURES

- Constant-current WLED Driver Controller
- 280mV Feedback Voltage with ±1.8% Accuracy
- 9V-28V Input Voltage
- Leading Edge Blanking for Current Sense
- Frequency Fixed 180kHz
- Fast PWM Dimming
- Soft Start
- Over Voltage Protection
- Short LED Protection
- Short Output Protection
- Over Current Protection
- Short Inductor/Diode Protection
- VIN UVLO
- Thermal Shutdown
- Available in SOIC-8 package

APPLICATIONS

- LCD Backlighting
- DC/DC LED Driver
- General Illumination

All MPS parts are lead-free, halogen free, and adhere to the RoHS directive. For MPS green status, please visit MPS website under Quality Assurance.

"MPS" and "The Future of Analog IC Technology" are Registered Trademarks of Monolithic Power Systems, Inc.



Warning: Although this board is designed to satisfy safety requirements, the engineering prototype has not been agency approved. Therefore, all testing should be performed using an isolation transformer to provide the AC input to the prototype board.

EV4008-S-00A EVALUATION BOARD

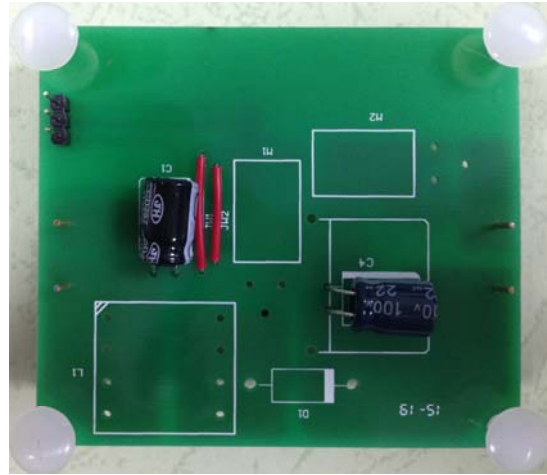

(L x W x H) 7.5cm x 6.5cm x 1.5cm

Board Number	MPS IC Number
EV4008-S-00A	MP4008GS

EVALUATION BOARD SCHEMATIC

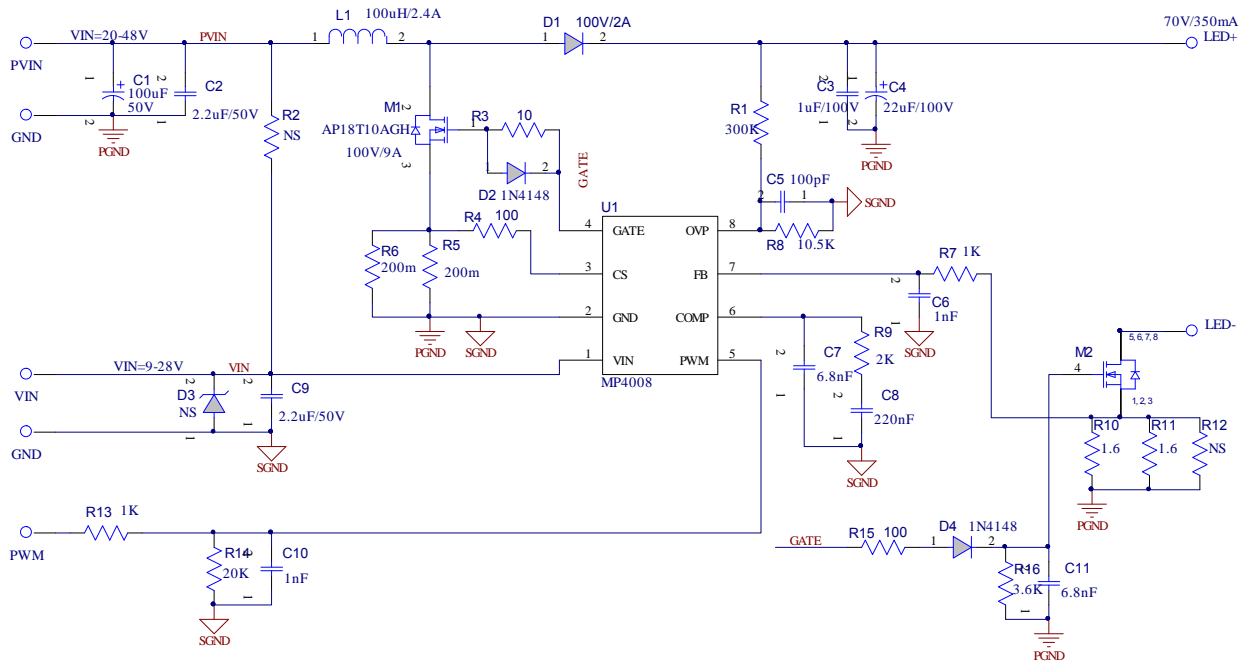

BILL OF MATERIALS

Qty	Ref	Value	Description	Package	Manufacture	Manufacture_PN
1	C1	100μF	Electrolytic Capacitor;50V	DIP	江海	CD287-50V100
2	C2	2.2μF/50V	Ceramic Capacitor; 50V;X7R; 1206	1210	TDK	C3225X7R1H225K
1	C3	1μF/100V	Ceramic Capacitor; 100V;X7R; 1210	1210	muRata	GRM32ER72A105KA01L
1	C4	22μF/100V	Electrolytic Capacitor;100V	DIP	江海	CD263-100V22
1	C5	100pF	Ceramic Capacitor; 50V;C0G; 0603	0603	TDK	C1608COG1H101J
2	C6, C10	1nF	Ceramic Capacitor; 50V;X7R; 0603;	0603	TDK	C1608X7R1H102K
2	C7, C11	6.8nF	Ceramic Capacitor; 50V;X7R; 0603	0603	LION	0603B682K500T
1	C8	220nF	Ceramic Capacitor; 16V;X7R; 0603;	0603	muRata	GRM188R71C224KA01D
1	C9	2.2μF/50V	Ceramic Capacitor; 50V;X7R; 1206	1206	muRata	GRM31CR71H225KA88L
1	D1	B2100	Shottky Diode;100V;2A;	SMB	Diodes	B2100
2	D2, D4	1N4148W	Diode;75V;0.15A;	SOD-123	Diodes	1N4148W
1	D3	NS				
2	JR1,JR2	0	Film Resistor;5%	1206	Yageo	RC1206JR-070R
1	L1	100μH/2.4A	Inductor;100μH;220m;2.4A	SMD	Würth	74477020
1	M1	AP18T10AGH	Mosfet;100V;160;9.6;9	TO-252	APEC	AP18T10AGH
1	M2	AM4490N	N-Channel Mosfet;100V;92;12.5; 5.2	SO-8	Analog Power	AM4490N
1	R1	300k	Resistor;1%;1/4W	1206	Yageo	RC1206FR-07300KL
2	R2, R12	NS				
1	R3	10	Film Resistor;5%;	0603	Yageo	RC0603JR-0710RL
2	R4, R15	100	Film Resistor;1%	0603	Yageo	RC0603FR-07100RL
2	R5, R6	200m	Film Resistor;1%;	1206	Yageo	RL1206FR-070R2L
2	R7, R13	1k	Film Resistor;5%;	0603	Yageo	RC0603FR-071KL
1	R8	10.5k	Film Resistor;1%	0603	Yageo	RC0603FR-0710K5L
1	R9	2k	Film Resistor;1%;	0603	Yageo	RC0603FR-072KL
2	R10, R11	1.6	Film Resistor;1%	1206	Yageo	RC1206FR-071R6L
1	R14	20k	Film Resistor;1%;1/10W;	0603	Yageo	RC0603FR-0720KL
1	R16	3.6k	Film Resistor;5%;1/10W	0603	LIZ	CR0603JA0362G
1	U1	MP4008GS	MP4008	SO-8	MPS	MP4008GS

EVB TEST RESULTS

PVIN=20-48V, VIN = 12V, VLED= 70V, ILED=350mA, TA = 25°C, unless otherwise noted.

PWM Dimming Curve

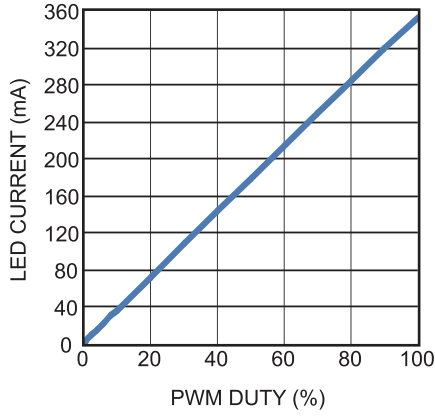

Efficiency vs. PVIN

VIN=12V, VLED=70V

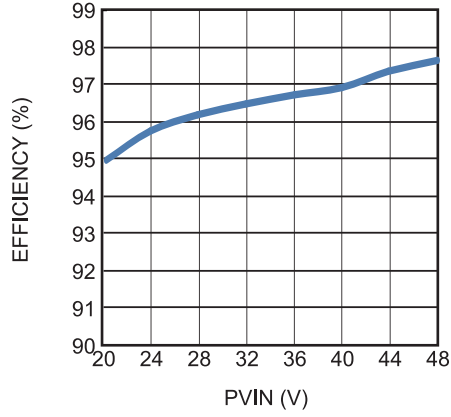

Efficiency vs. VLED

VIN=12V, PVIN=20V

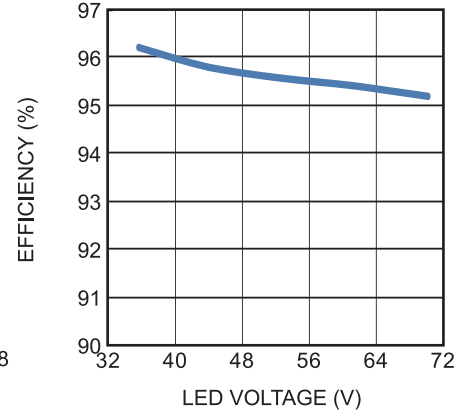

TYPICAL PERFORMANCE CHARACTERISTICS (continued)
 $V_{IN}=12V, PV_{IN}=20V, V_{LED}=70V, I_{LED}=350mA, L=100\mu H, T_A=25^\circ C$, unless otherwise noted.

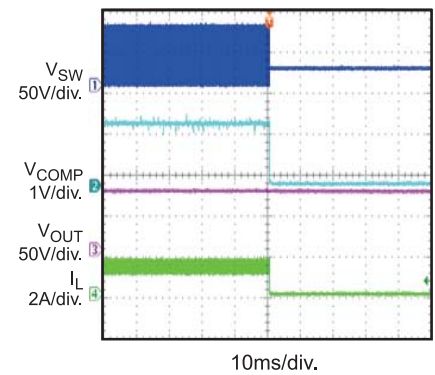
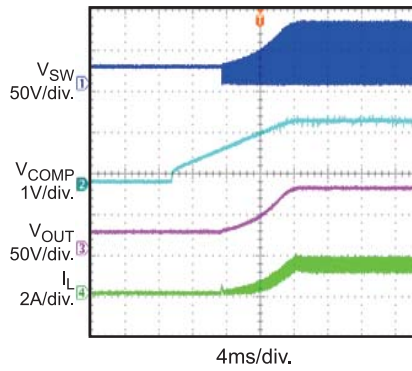
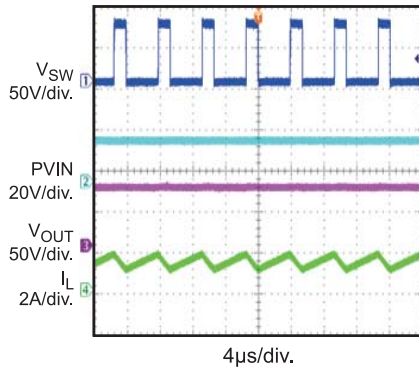
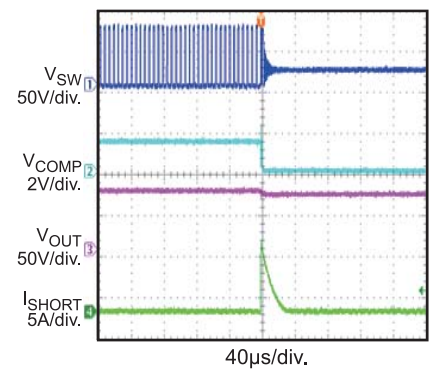
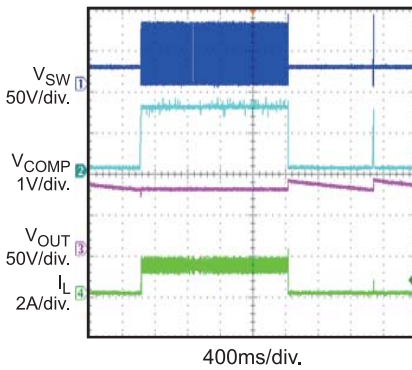
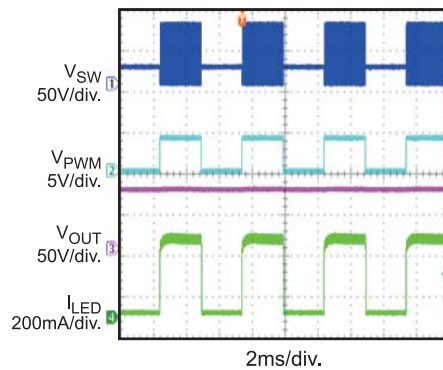
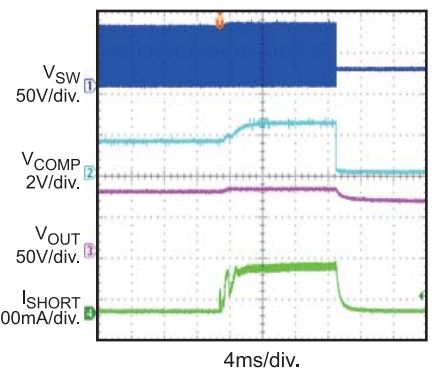
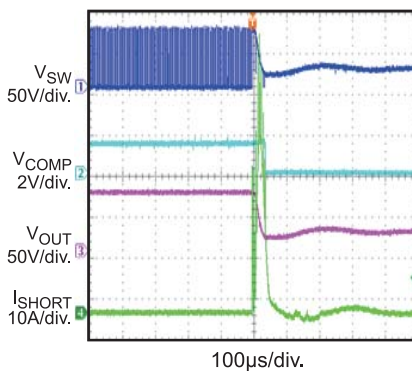
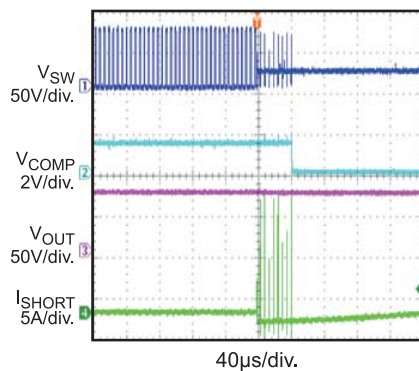
Steady State
 V_{IN} Start-Up
 V_{IN} OFF

PWM Dimming
 $f_{PWM}=200Hz, Duty=50\%$
Open-Load Protection
Short-Load Protection

Short-Inductor Protection
Short-Diode Protection
Short LED- to GND Protection

PRINTED CIRCUIT BOARD LAYOUT

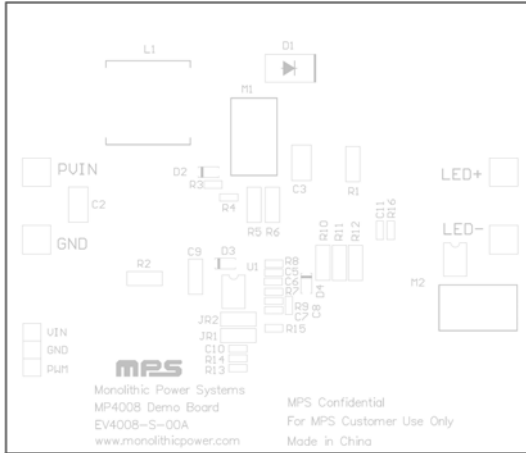

Figure 1—Top Silk Layer

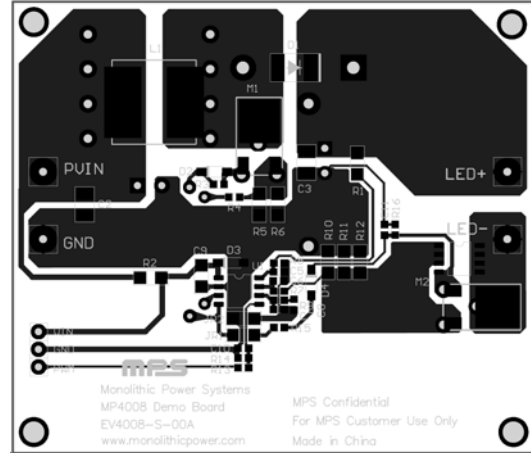

Figure 2—Top Layer

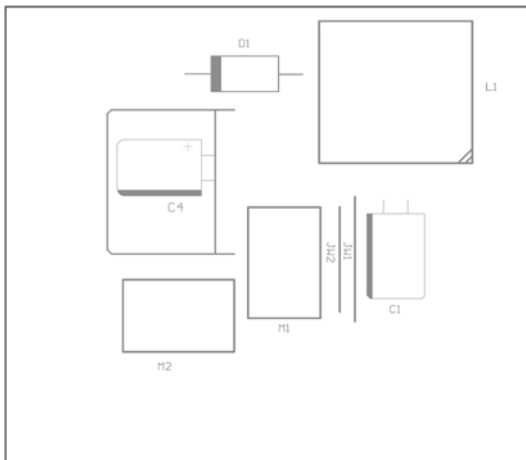

Figure 3—Bottom Silk Layer

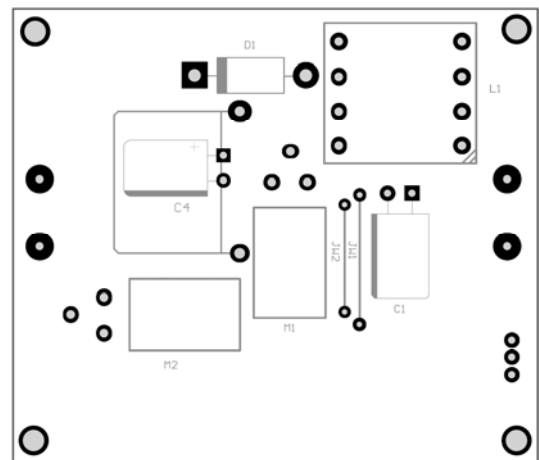

Figure 4—Bottom Layer

QUICK START GUIDE

1. Preset the LED string forward voltage to 70V, connect the anode of LED string to 'LED+' and the cathode of LED string to 'LED-';
2. Preset the PVIN supply voltage to 20-48V, turn off the power supply, connect the power supply to 'PVIN';
3. Preset the VIN supply voltage 9-28V, turn off the power supply, connect the power supply to 'VIN';
4. Connect the 'PWM' connector to the PWM dimming signal; the high level of PWM signal is in the range of 1.5V-5V, and the low level is in the range of 0-0.4V;
5. Turn on PVIN supply, set PWM signal to high level, turn on VIN supply, the LED string should be ignited.
6. To demo the PWM dimming function: connect the 'PWM' connector to an PWM signal; the frequency of the PWM signal is in the range of 100Hz to 2kHz, the high level of the PWM signal is 1.5V-5V and low level is 0-0.8V. Adjust the duty of the PWM signal; the LED current will follow the duty of the PWM dimming signal.

NOTICE: The information in this document is subject to change without notice. Please contact MPS for current specifications. Users should warrant and guarantee that third party Intellectual Property rights are not infringed upon when integrating MPS products into any application. MPS will not assume any legal responsibility for any said applications.