



The Future of Analog IC Technology®

EV3429-L-00A

21A High Efficiency Fully-Integrated Synchronous Boost Converter EV Board

DESCRIPTION

EV3429-L-00A Evaluation Board is designed to demonstrate the capability of MP3429. The MP3429 is a 600kHz fixed frequency, wide input range, highly integrated boost converter. It starts from an input voltage as low as 2.7V, and supports up to 30W load power from 1-cell battery.

MP3429 adopts constant-off-time (COT) control topology providing fast transient response. One MODE pin supports mode selection of PSM, FCCM and USM in light load condition. And the integrated LS and HS MOSFET simplify the design and save BOM cost.

The MP3429 also features with programmable input UVLO and over temperature protection.

The MP3429 is available in a 13-pin 3mmx4mm QFN package.

Electrical Specification

Parameter	Symbol	Value	Units
Input Voltage	V_{IN}	2.7-8.4	V
Output Voltage	V_{OUT}	9	V
Output Current	I_{OUT}	3.5 ⁽¹⁾	A

Note:

1) When $V_{IN}=2.7V$, $I_{OUT}=3.5A$, the case temperature should be high, It is limited by PCB size. Please decrease the load based the permitted temperature performance.

FEATURES

- 2.7V-to-13V Startup Voltage
- 0.8V-to-13V Operation Voltage
- Up to 16V Output Voltage
- Support 30W Average Power Load and 40W Peak Power Load from 3.3V
- 21.5A Internal Switch Current Limit
- Integrated 6.5mΩ & 10mΩ Power MOSFET
- >95% Efficiency for 3.6V V_{IN} to 9V/3A
- Selectable PSM, >23kHz USM, and FCCM Mode in Light Load Condition
- 600kHz Fixed Switching Frequency
- Adaptive COT for Fast Transient Response
- External Soft Start and Compensation Pin
- Programmable UVLO and Hysteresis
- 150°C Over Temperature Protection
- Available in 3x4mm QFN-13 Package

APPLICATIONS

- Notebook
- Bluetooth Speaker
- Portable POS System
- Quick Charger Power Bank

All MPS parts are lead-free and adhere to the RoHS directive. For MPS green status, please visit MPS website under Products, Quality Assurance page.

"MPS" and "The Future of Analog IC Technology" are Registered Trademarks of Monolithic Power Systems, Inc.

EV3429-L-00A EVALUATION BOARD



(L x W x H) 6.35cm x 6.35cm x 0.6cm

Board Number	MPS IC Number
EV3429-L-00A	MP3429GL

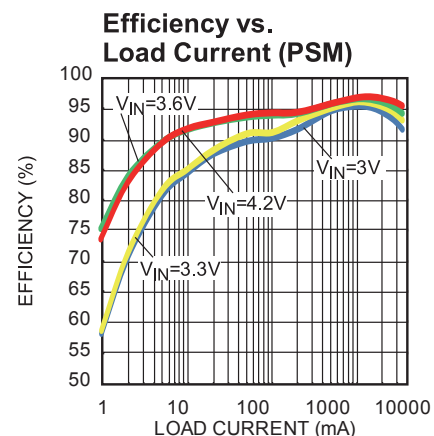

EVALUATION BOARD SCHEMATIC

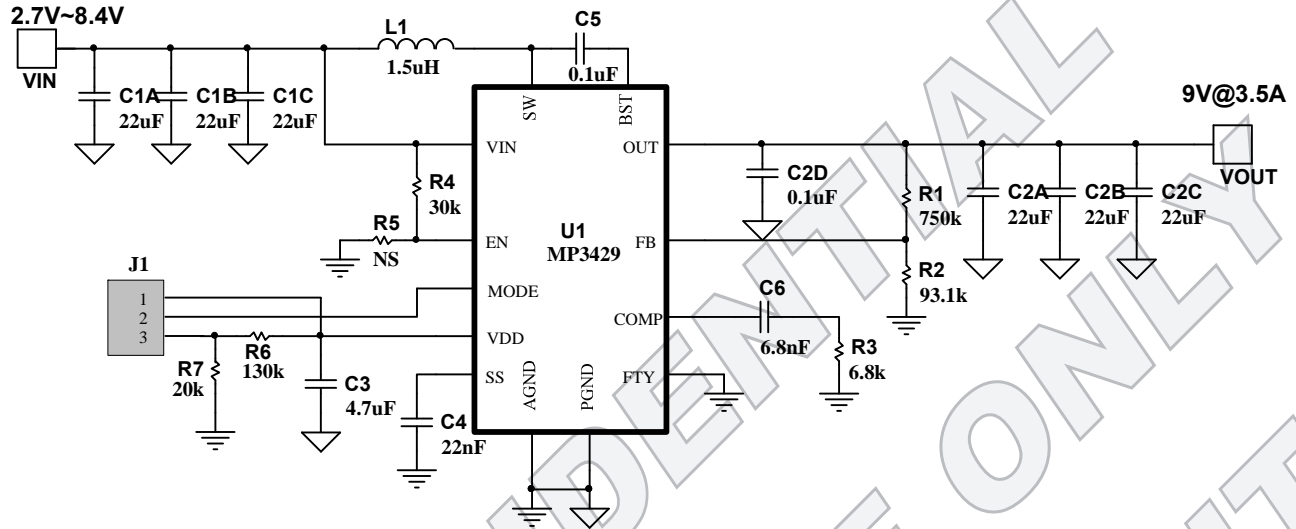

EV3429-L-00A BILL OF MATERIALS

Qty	Ref	Value	Description	Package	Manufacturer	Part Number
6	C1A, C1B, C1C, C2A, C2B, C2C	22 μ F	Ceramic Cap,25V,X5R	1210	MuRata	GRM32ER61E226KE15L
2	C2D, C5	0.1 μ F	Ceramic Cap,25V,X7R	0603	MuRata	GRM188R71E104KA01D
1	C3	4.7 μ F	Ceramic Cap,6.3V,X5R	0603	MuRata	GRM188R71J475KA01D
1	C4	22nF	Ceramic Cap,16V,X7R	0603	MuRata	GRM188R71C223KA01D
1	C6	6.8nF	Ceramic Cap,50V,X7R	0603	MuRata	GRM188R71H682KA01D
1	R1	750K	Film Res,1%	0603	ROYAL	RL0603FR-07750KL
1	R2	93.1K	Film Res,1%	0603	ROYAL	RL0603FR-0793K1L
1	R3	6.8K	Film Res,1%	0603	ROYAL	RL0603FR-076K8L
1	R4	30K	Film Res,1%	0603	ROYAL	RL0603FR-0730KL
0	R5	NC				
1	R6	130K	Film Res,1%	0603	ROYAL	RL0603FR-07130KL
1	R7	20K	Film Res,1%	0603	ROYAL	RL0603FR-0720KL
1	L1	1.5 μ H	$I_{RMS}=19A$, $R_{DC}=3.3m\Omega$	11.5x10mm	Sumida	104CDMCCDS-1R5MC-ND
1	J1	Jumper	Short Jumper, 2.54mm			Jumper
1	U1	MP3429	Boost converter	QFN 3X4mm	MPS	MP3429GL

EVB TEST RESULTS

$V_{IN} = 3.3V$, $V_{OUT} = 9V$, $L = 1.5\mu H$, $I_{OUT} = 3.5A$, PSM, $T_A = 25^\circ C$, unless otherwise noted.

Efficiency vs. Load Current (PSM)

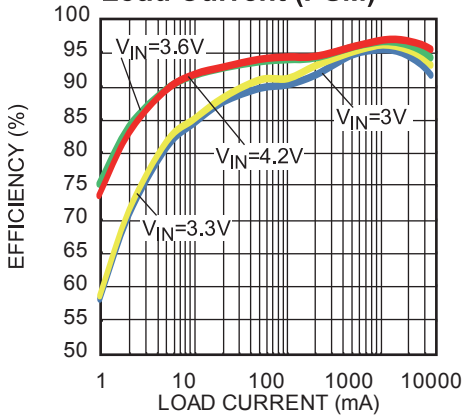

Load Regulation (PSM)

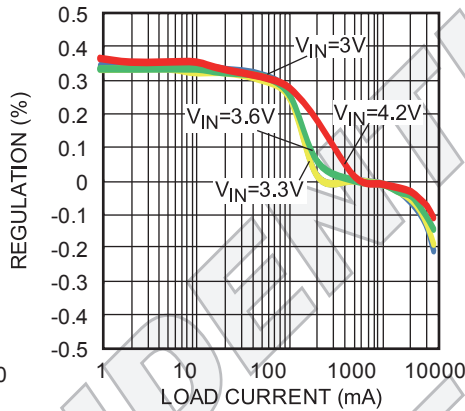

Line Regulation (PSM)

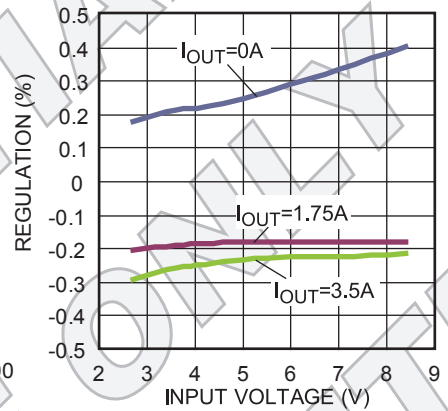

Bode Plot

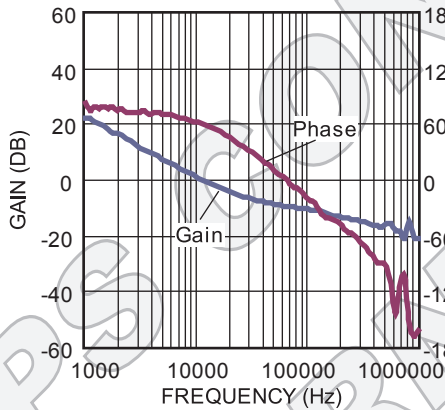

Case Temperature Rising

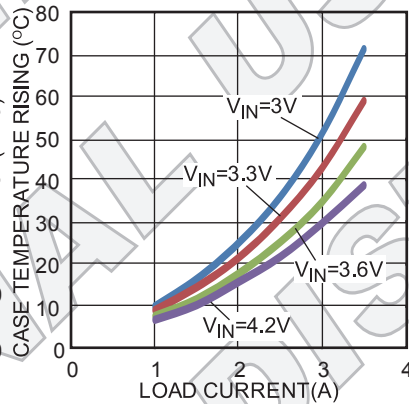

EVB TEST RESULTS (continued)

$V_{IN} = 3.3V$, $V_{OUT} = 9V$, $L = 1.5\mu H$, $I_{OUT} = 3.5A$, PSM, $T_A = 25^\circ C$, unless otherwise noted.

Steady State
 $I_{OUT} = 0A$, USM

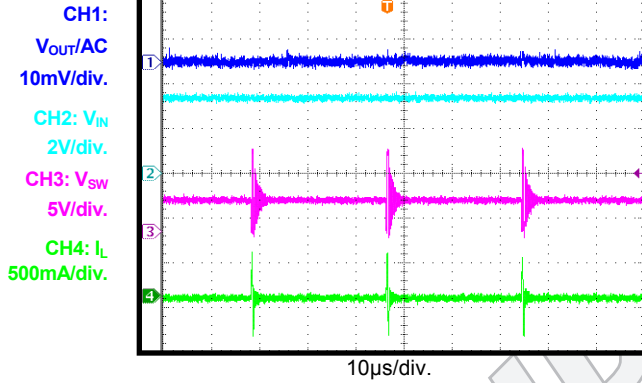

Steady State
 $I_{OUT} = 0A$, PSM

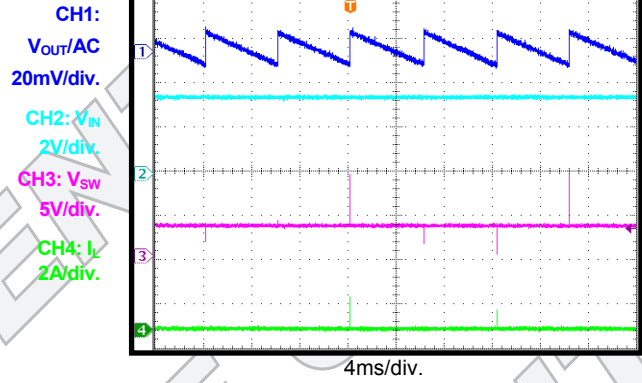

Steady State
 $I_{OUT} = 0A$, FCCM

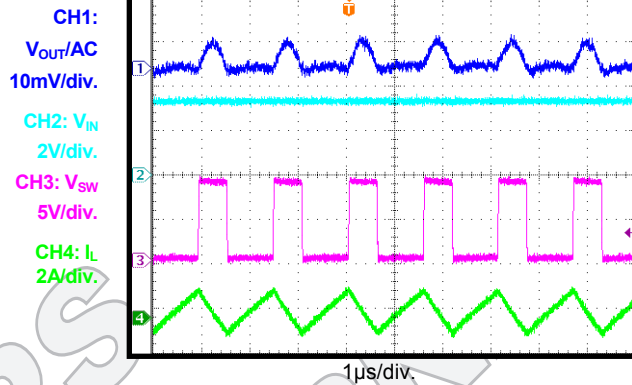

Steady State
 $I_{OUT} = 3.5A$

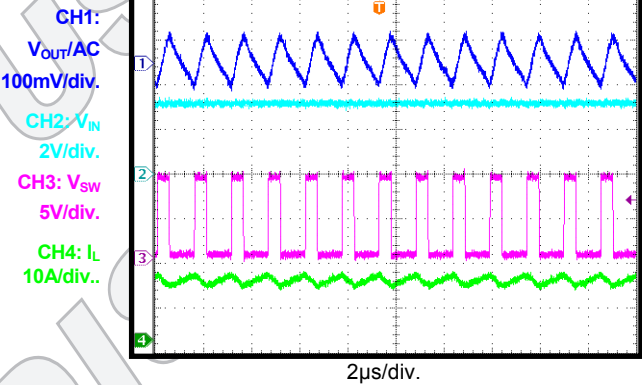

V_{IN} Start-Up
 $I_{OUT} = 0A$

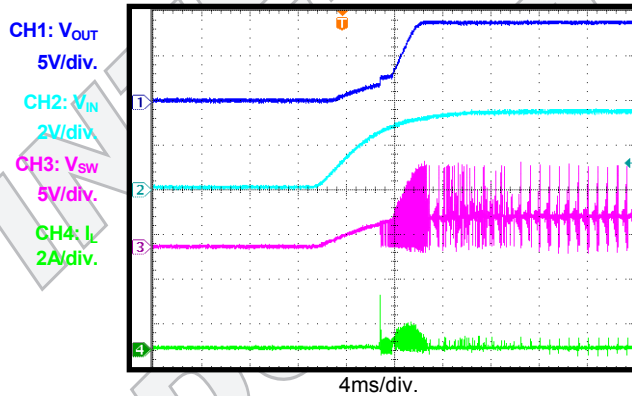

V_{IN} Start-Up
 $I_{OUT} = 3.5A$

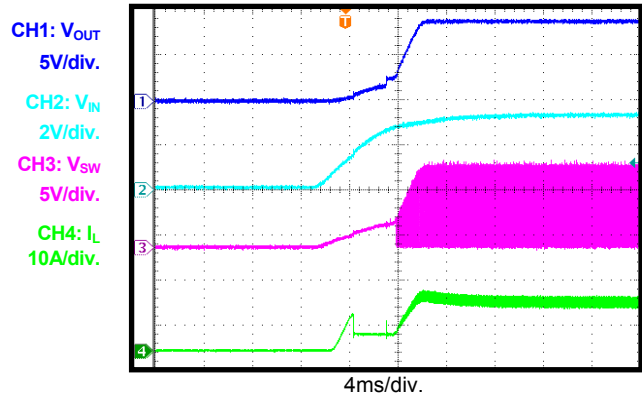

EVB TEST RESULTS (continued)

$V_{IN} = 3.3V$, $V_{OUT} = 9V$, $L = 1.5\mu H$, $I_{OUT} = 3.5A$, PSM, $T_A = 25^\circ C$, unless otherwise noted.

V_{IN} Shutdown
 $I_{OUT} = 0A$

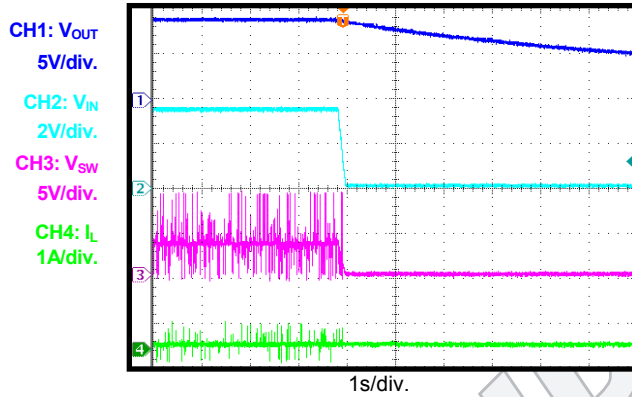

V_{IN} Shutdown
 $I_{OUT} = 3.5A$

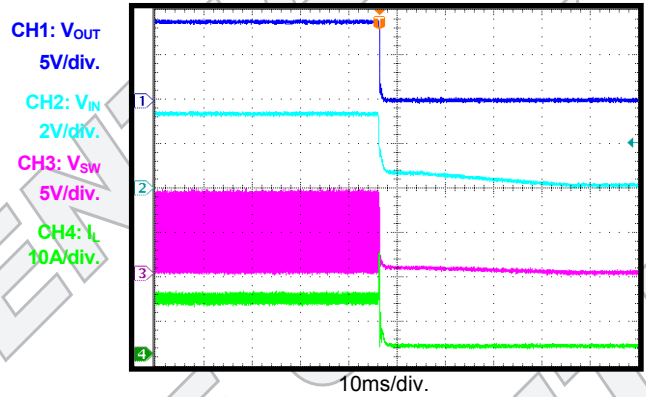

EN Start-Up
 $I_{OUT} = 0A$

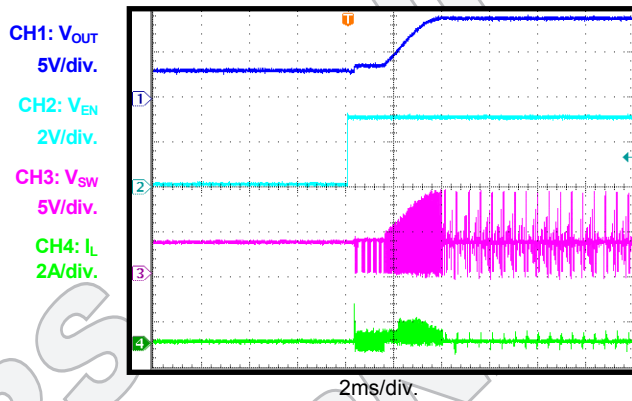

EN Start-Up
 $I_{OUT} = 3.5A$

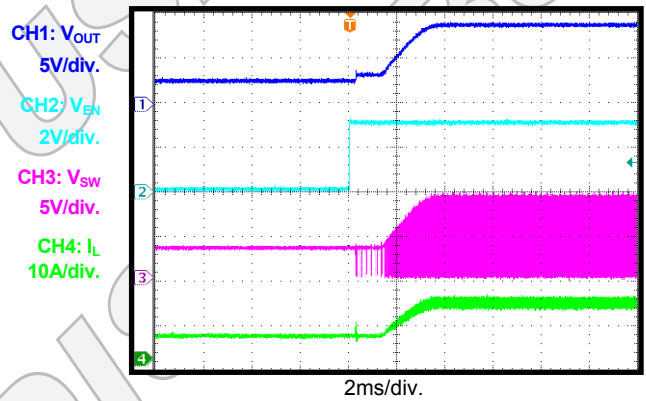

EN Shutdown
 $I_{OUT} = 0A$

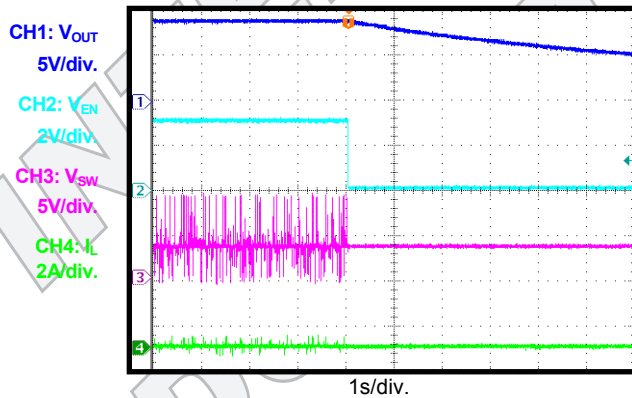

EN Shutdown
 $I_{OUT} = 3.5A$

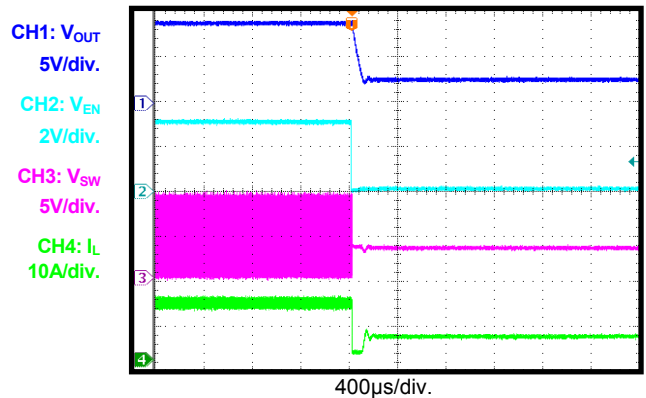

EVB TEST RESULTS (continued)

$V_{IN} = 3.3V$, $V_{OUT} = 9V$, $L = 1.5\mu H$, $I_{OUT} = 3.5A$, PSM, $T_A = 25^\circ C$, unless otherwise noted.

Load Transient

$I_{OUT} = 0A \rightarrow 1.75A$, $I_{RAMP} = 25mA/\mu s$, USM

CH1:
 V_{OUT}/AC
500mV/div.
CH4: I_{OUT}
2A/div.

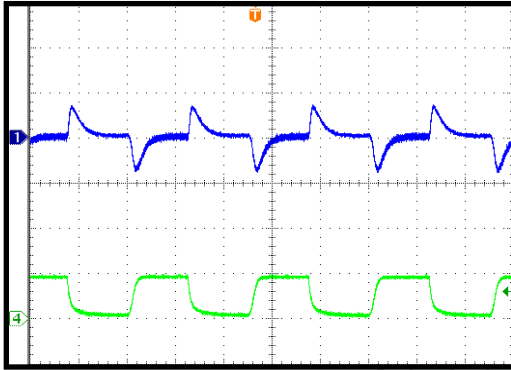

400µs/div.

Load Transient

$I_{OUT} = 3.5A \rightarrow 1.75A$, $I_{RAMP} = 25mA/\mu s$

CH1:
 V_{OUT}/AC
500mV/div.
CH4: I_{OUT}
2A/div.

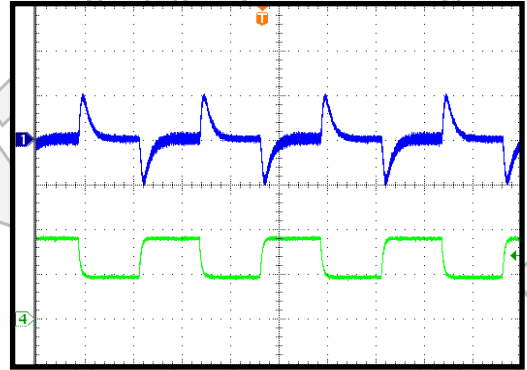

400µs/div.

Load Transient

$I_{OUT} = 0A \rightarrow 1.75A$, $I_{RAMP} = 25mA/\mu s$, PSM

CH1:
 V_{OUT}/AC
500mV/div.
CH4: I_{LOAD}
2A/div.

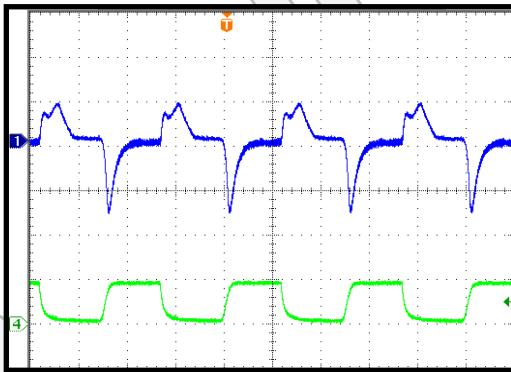

400µs/div.

Load Transient

$I_{OUT} = 0A \rightarrow 1.75A$, $I_{RAMP} = 25mA/\mu s$, FCCM

CH1:
 V_{OUT}/AC
500mV/div.
CH4: I_{LOAD}
2A/div.

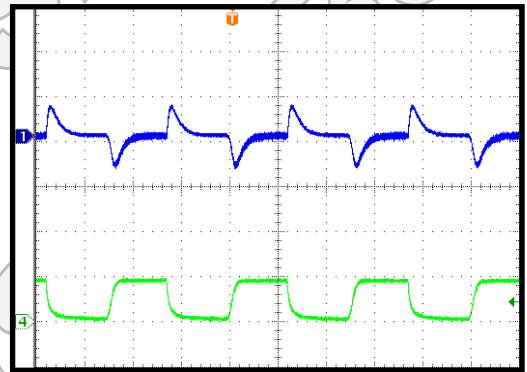

400µs/div.

PRINTED CIRCUIT BOARD LAYOUT

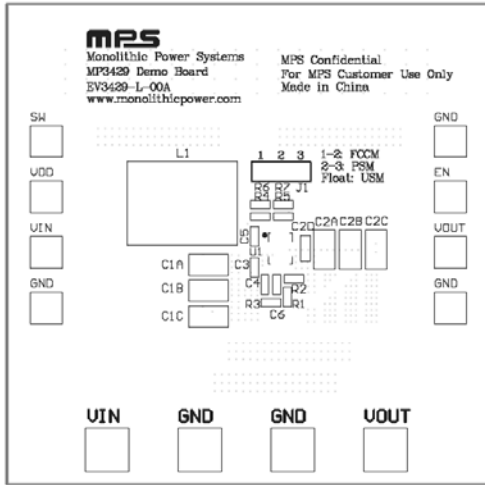

Figure 1—Top Silk Layer

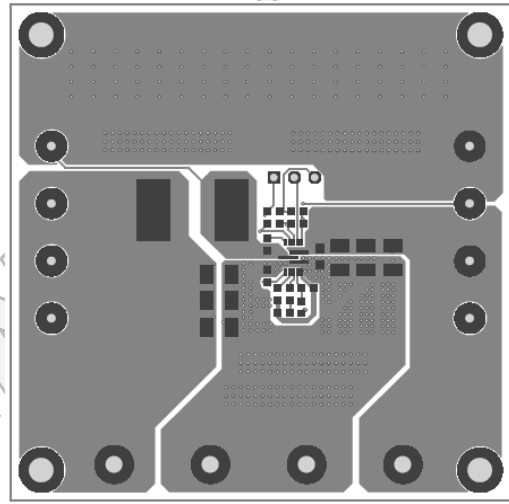

Figure 2—Top Layer

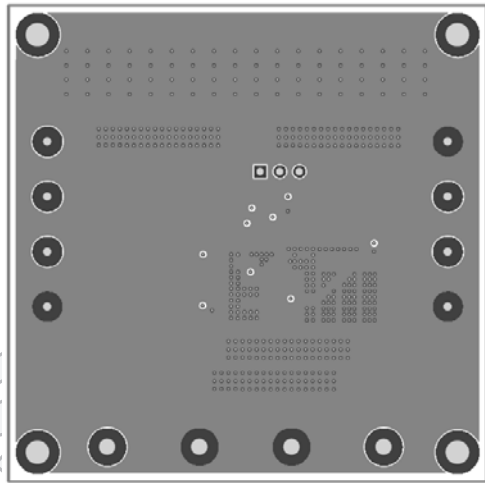

Figure 3—Inner Layer 1

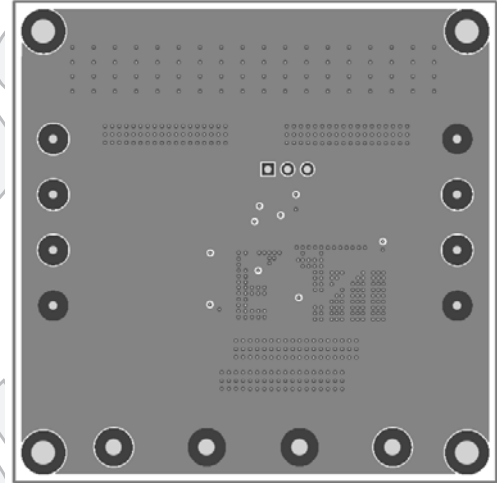

Figure 4—Inner Layer 2

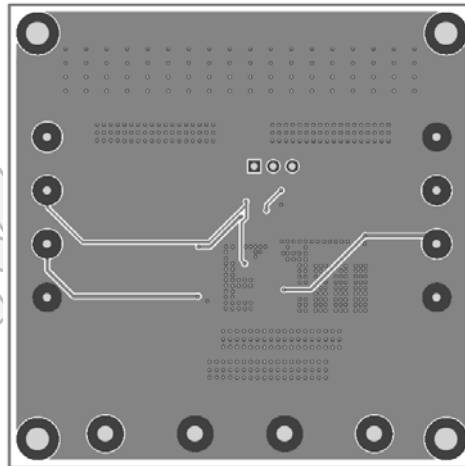

Figure 5—Bottom Layer

QUICK START GUIDE

The output voltage of this board is set to 9V. The board layout accommodates most commonly used components. Following are steps to quick start EV3429-L-00A.

1. Preset Power Supply to $2.7V \leq V_{IN} \leq 8.4V$.
2. Turn Power Supply off.
3. Connect Power Supply terminals to:
 - a. Positive (+): VIN
 - b. Negative (-): GND
4. Connect Load to:
 - a. Positive (+): VOUT
 - b. Negative (-): GND
5. Turn Power Supply on after making connections.
6. The MP3429 is enabled on the evaluation board once VIN is applied.
7. The output voltage VOUT can be changed by varying R2. Calculate the new value using the formula:

$$V_{OUT} = V_{FB} \times \left(1 + \frac{R1}{R2}\right)$$

Where $V_{FB} = 1V$ and $R1 = 750k\Omega$.

8. If USM and FCCM is needed, following below steps:
 - a. Turn Power Supply off.
 - b. Change J1 connection. Connect 1 to 2 for FCCM, connect 2 to 3 for PSM, and float 2 for USM.
 - c. Turn the power on. IC will work with the mode which is set by step b.

NOTICE: The information in this document is subject to change without notice. Please contact MPS for current specifications. Users should warrant and guarantee that third party Intellectual Property rights are not infringed upon when integrating MPS products into any application. MPS will not assume any legal responsibility for any said applications.