

DESCRIPTION

The MP3385 is a step-up controller with 4 regulated current channels designed to drive WLED arrays for middle and large-size LCD panel backlighting applications.

The MP3385 uses peak current mode, PWM control architecture for system loop regulation. It drives an external MOSFET to boost up the output voltage from a 4.5V to 33V input supply.

It employs an I²C digital interface and can flexibly set the operation and protection modes, including dimming mode, dimming current and dimming ratio, OCP, OVP, LED short protection threshold, and the switching frequency. For easy application use and board debugging, the MP3385 detects and automatically disables the unused LED strings during start-up to avoid charging the output to the OVP threshold.

The MP3385 achieves 1.8% current matching between each string. The low regulation voltage on the LED current sources improves efficiency and reduces power loss in order to achieve a higher current output.

The MP3385 supports analog, PWM, and combined analog and PWM dimming modes to meet different application requirements. Full protection features include OCP, OTP, UVP, OVP, LED short/open protection, and inductor/diode short protection.

The MP3385 is available in a QFN-20 4mm x 4mm and a TSSOP20-EP package.

ELECTRICAL SPECIFICATIONS

Parameter	Symbol	Value	Units
Input Voltage	V _{IN}	4.5 – 33	V
Output Voltage	V _{LED}	<80	V
LEDs #		4 string	
LED Current	I _{LED}	120/string	mA

FEATURES

- 4-String, Max 300mA/String WLED Driver
- 4.5V to 33V Input Voltage Range
- 80V Abs. Rating for Each String
- 1.8% Current Matching Accuracy for Each String
- Unused Channel Auto-Detection Function during Start-Up
- 100kHz-900kHz Programmable Switching Frequency
- Multiple Dimming Modes Selected by I²C Interface:
 1. Direct PWM Dimming Mode
 2. Internal Fixed 23kHz PWM Dimming Mode
 3. Analog Dimming Mode by Input Pulse
 4. Internal Analog Dimming Mode
 5. Mixed Dimming Mode by Input Pulse
 6. Internal Mixed Dimming Mode
- 2%-100% Programmable Full Scale Current with 8-Bit Resolution
- 0%-100% LED Dimming Range with 10-Bit Resolution for Internal Dimming Mode
- Cascading Capability with a Single Power Source
- 18V to 80V Over-Voltage Protection, 2V/Step
- 0.15V to 0.5V Latch-Off/Recoverable OCP Protection Threshold, 50mV/Step
- Recoverable Thermal Shutdown Protection

APPLICATIONS

- Desktop LCD Flat Panel Displays
- All In One
- 2D/3D LCD TVs

All MPS parts are lead-free and adhere to the RoHS directive. For MPS green status, please visit MPS website under Products, Quality Assurance page.

"MPS" and "The Future of Analog IC Technology" are registered trademarks of Monolithic Power Systems, Inc.

EV3385-R-00A EVALUATION BOARD

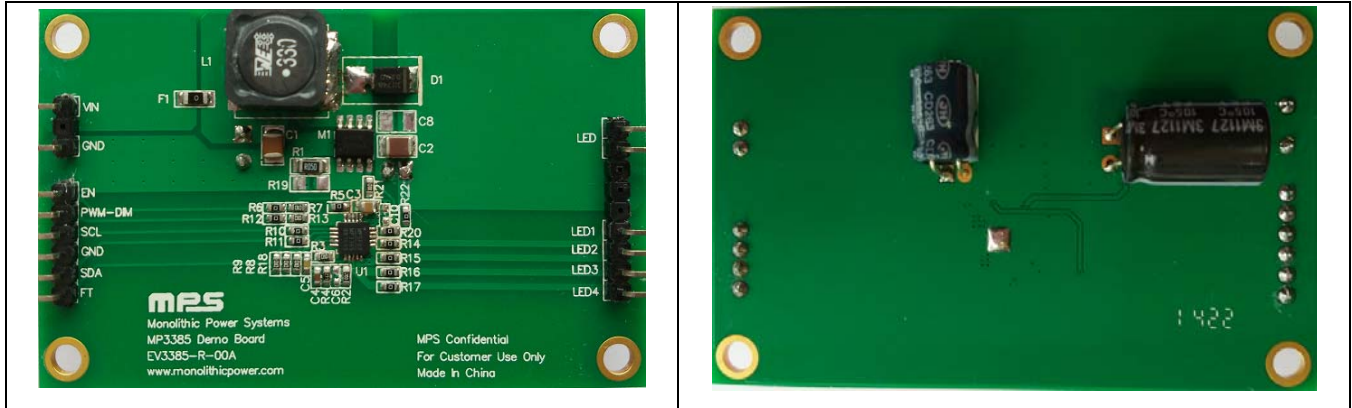

(L x W x H) 7.75cm x 4.88cm x 1.56cm

Board Number	MPS IC Number
EV3385-R-00A	MP3385GR

EVALUATION BOARD SCHEMATIC

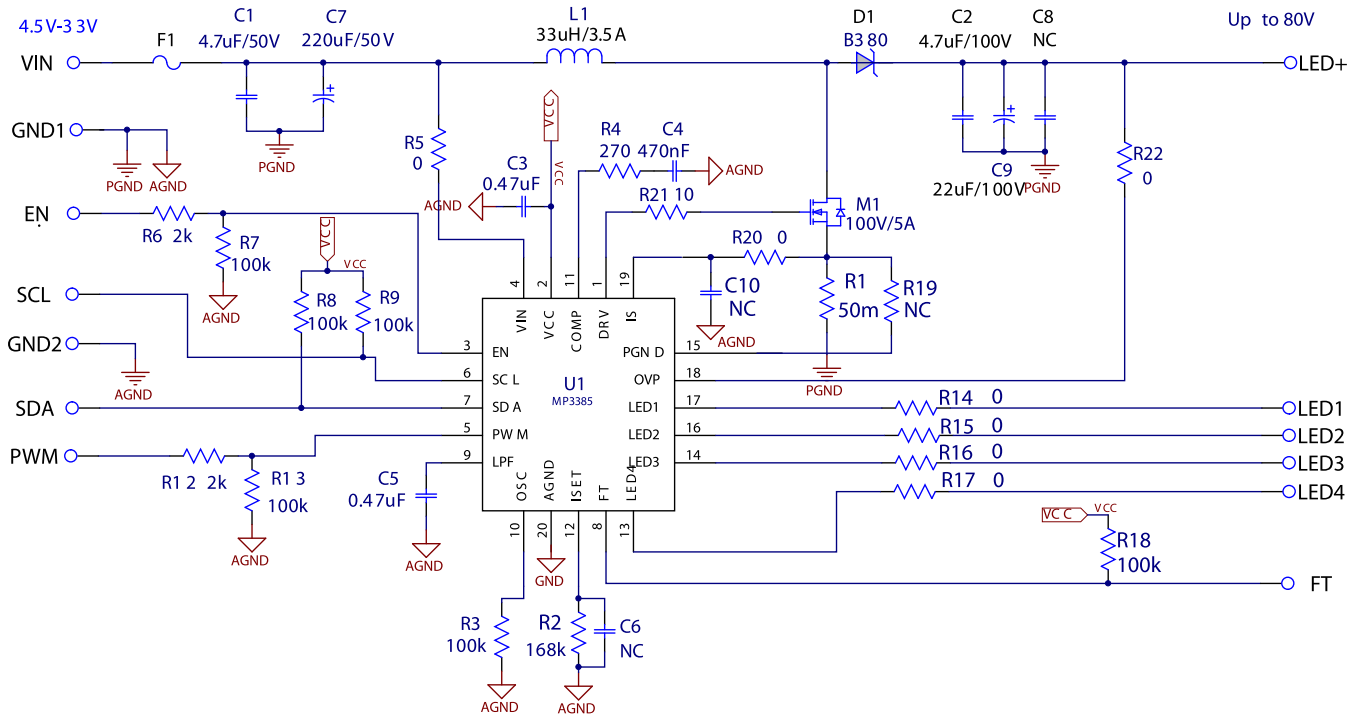

Note: Please remove the capacitor with LPF pin when working in direct PWM dimming..

EV3385-R-00A BILL OF MATERIALS

Qty	Ref	Value	Description	Manufacturer	Manufacturer P/N
1	C1	4.7μF/50V	CAP/1210	TDK	C3225X7R1H475K
1	C2	4.7μF/100V	CAP/1210	TDK	C3225X7S2A475K
1	C3	0.47μF/25V	CAP/0805	TDK	C2012X7R1E474K
1	C4	470nF/16V	CAP/0603	TDK	C1608X7R1C474K
1	C5	100nF/25V	CAP/0603	Yageo	CC0603KRX7R
2	C6,C10	NC	CAP/0603		
1	C7	47μF/50V	CAP/ELECT/DIP	江海	CD287-50V47
1	C8	NC	CAP/1210		
1	C9	22μF/100V	CAP/ELECT/DIP	江海	CD263-100V22
1	D1	B380	DIODES/SMC	DIODES	B380-13-F
1	F1	0	FUSE/1206	COOPER	CC12H4A
1	L1	33μH/3.2A	SMD	Würth	744770133
1	M1	AM4490N	SO8	Analog Power	AM4490N
1	R1	50m	RES/1206	Yageo	RL1206FR-070R05L
1	R2	168k	RES/0603	Yageo	RC0603FR-07160KL
6	R3,R7, R8,R9,R13,R18,	100k	RES/0603	Yageo	RC0603FR-07100KL
1	R4	270	RES/0603	Yageo	RC0603FR-07270RL
9	R5,R10~R11, R14~R17,R20,R22	0	RES/0603	Yageo	RC0603FR-070RL
2	R6,R12	2k	RES/0603	Yageo	RC0603FR-072KL
1	R19	NC	RES/1206		
1	R21	10	RES/0603	Yageo	RC0603FR-0710RL
1	U1	MP3385	QFN20/4X4MM/EP		MP3385
13	EN, FT, GND, LED, LED1, LED2, LED3, LED4, PWM-DIM, SCL, SDA, VIN,GND		TP		Bend terminal

EVB TEST RESULTS

Performance waveforms are tested on the evaluation board.

$V_{IN} = 12V$, $V_{EN} = 3.3V$, 120mA/string, 4string, 14LEDs, $T_A = 25^\circ C$, unless otherwise noted.

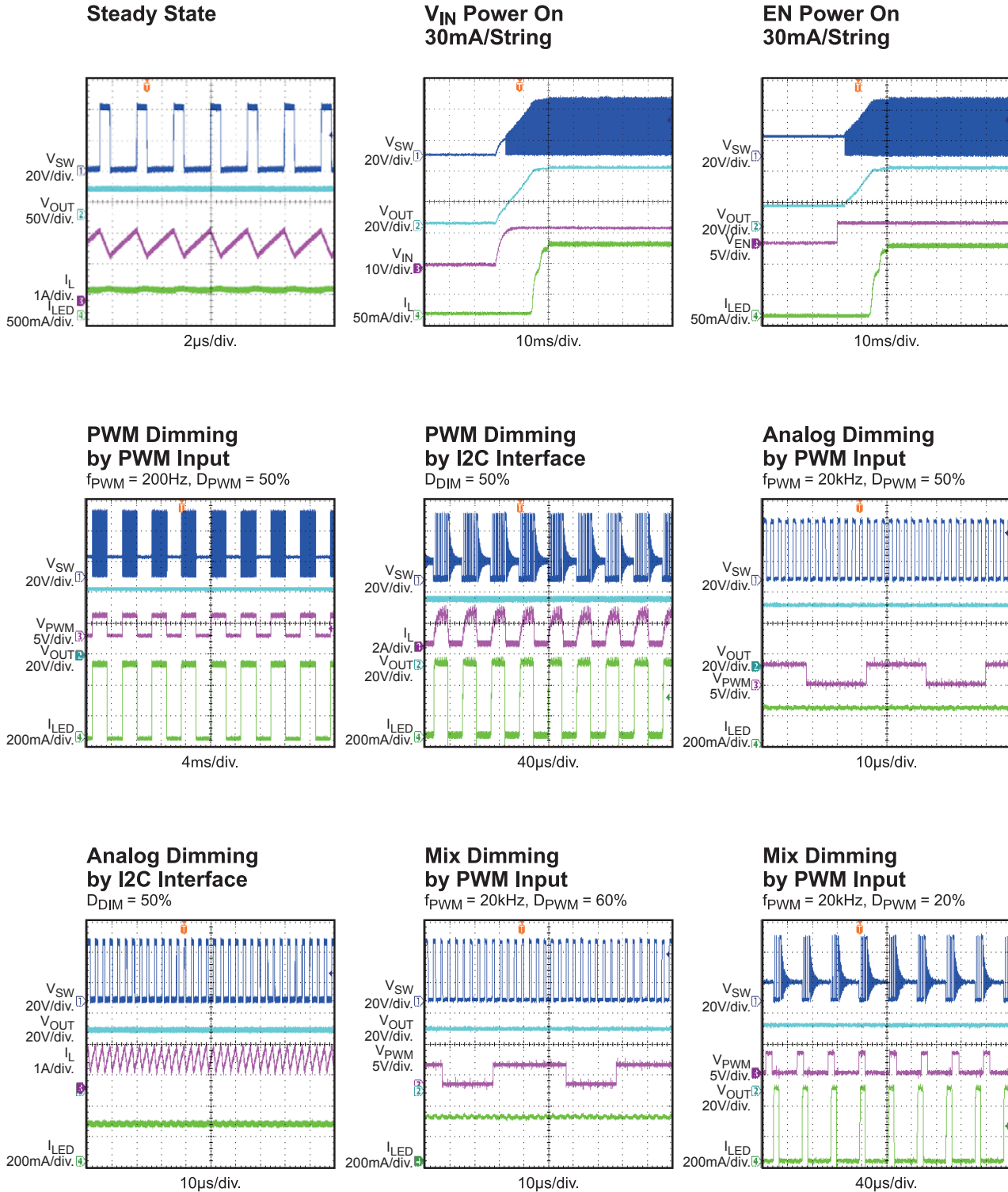

EVB TEST RESULTS *(continued)*

Performance waveforms are tested on the evaluation board.

V_{IN} = 12V, V_{EN} = 3.3V, 120mA/string, 4string, 14LEDs, T_A = 25°C, unless otherwise noted.

Mix Dimming by I2C Interface
D_{DIM} = 60%

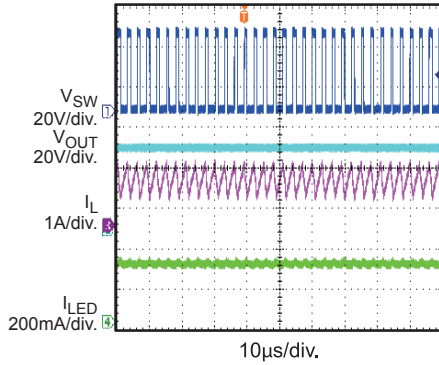

Mix Dimming by I2C Interface
D_{DIM} = 20%

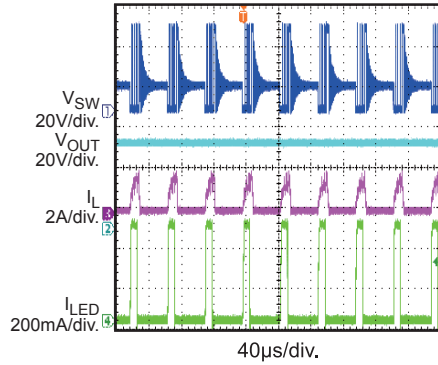

Unused String Protection when V_{IN} Power On

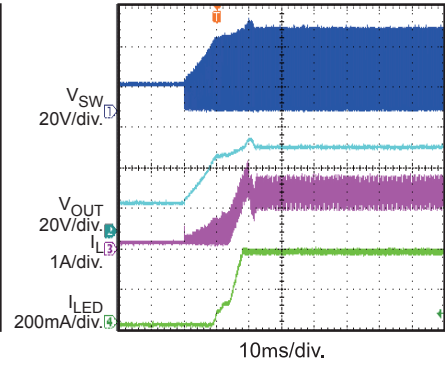

Open One String

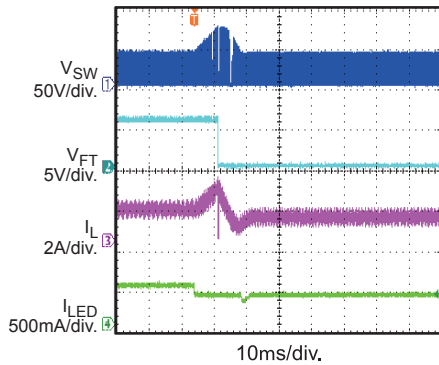

Short One String

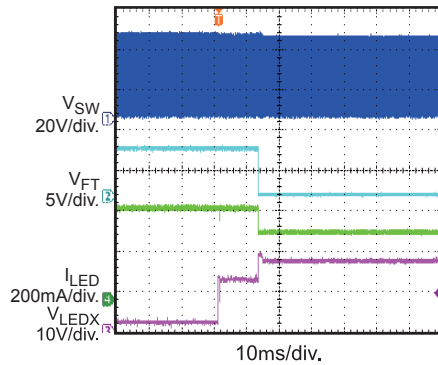

Short Inductor Protection

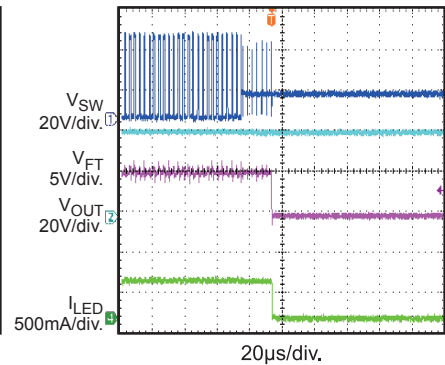

Short Diode Protection

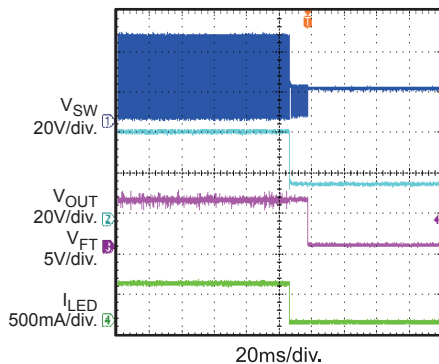

PRINTED CIRCUIT BOARD LAYOUT

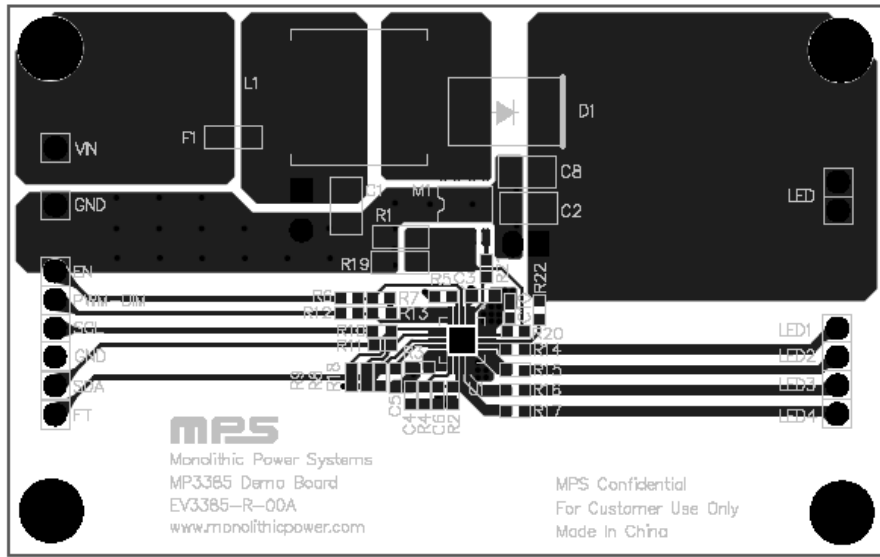

Figure 1—Top Layer

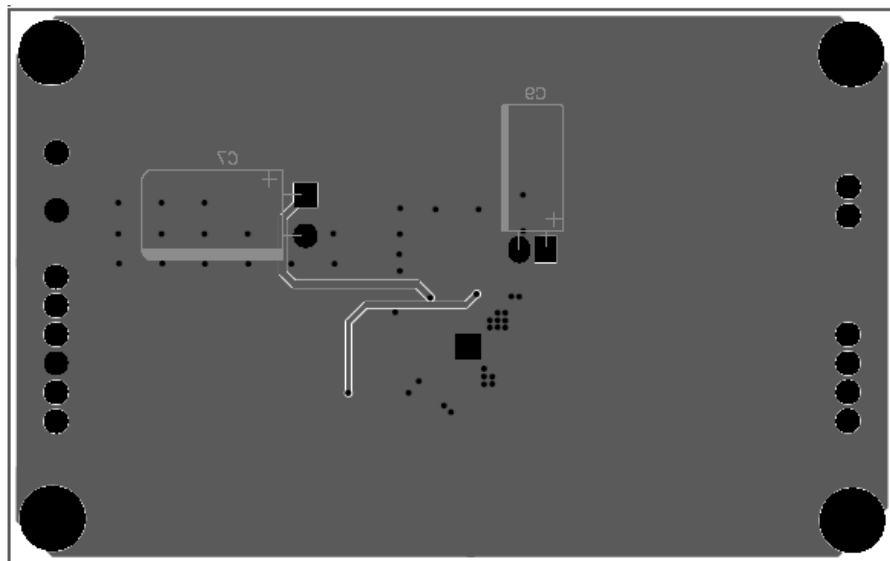

Figure 2—Bottom Layer

QUICK START GUIDE

1. Connect the positive and negative terminals of the power supply (4.5V ~ 33V) to the VIN and GND pins on the EV board, respectively.
2. Connect the positive and negative terminals of the load panel (4 strings) to the LED+ and LED1~4 pins on the EV board, respectively.
3. Drive EN pin high (>1.5V) to enable the MP3385.
4. If work in external dimming mode, please add PWM input signal to PWM terminal on the EV board. If work in internal dimming mode, nothing is need for PWM pin.
5. Please connect SCL, SDA and GND of EV board to SCL, SDA and GND of a programmable kit with I²C interface, respectively.
6. I²C interface setup

External Connection

Please prepare the relative devices and connecting lines before testing, including a computer (PC), a programmable kit with I²C interface, MP3385 EV board, one USB cable and three connection wires with plugs. All the devices are ready, complete connection including the three devices shown in the figure 1.

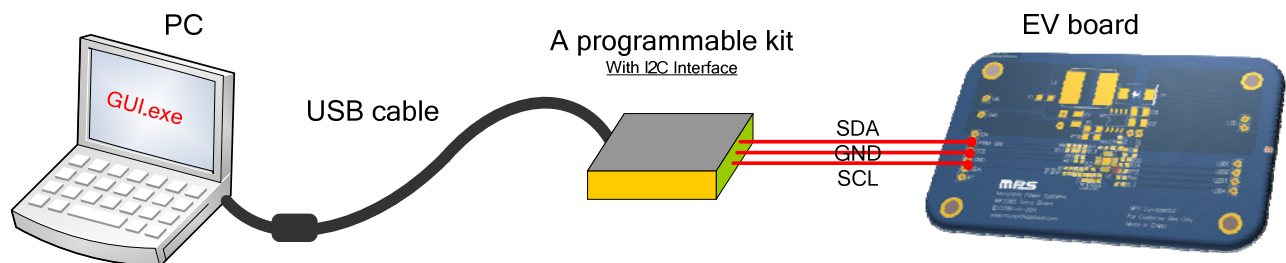

Figure 1—I²C Interface Connection

Soft Setup

Make sure USB driver installed before running GUI. Then run “MP3385 GUI.exe“ on your PC which realizes communication with EVB by a programmable kit with I²C interface. See from figure 2, kinds of buttons, like radio box, slide, and press button allow control register parameters which are only accessible through the software. Clicking to any button of GUI means to write/read data to /from register. With the help of GUI, it will be an easy and relax thing to set 0x00-0x06 registers of MP3385.

The GUI shown in figure2 appears by default when running the software. There are mainly 7 parts included in MP3385’s GUI.

- 1) BASIC SETTING
- 2) DIMMING MODE
- 3) LED CURRENT SOURCE ENABLE
- 4) Dimming By I2C Interface
- 5) FAULT DISPLAY
- 6) ALL REGISTER DISPLAY
- 7) USB connection judgment

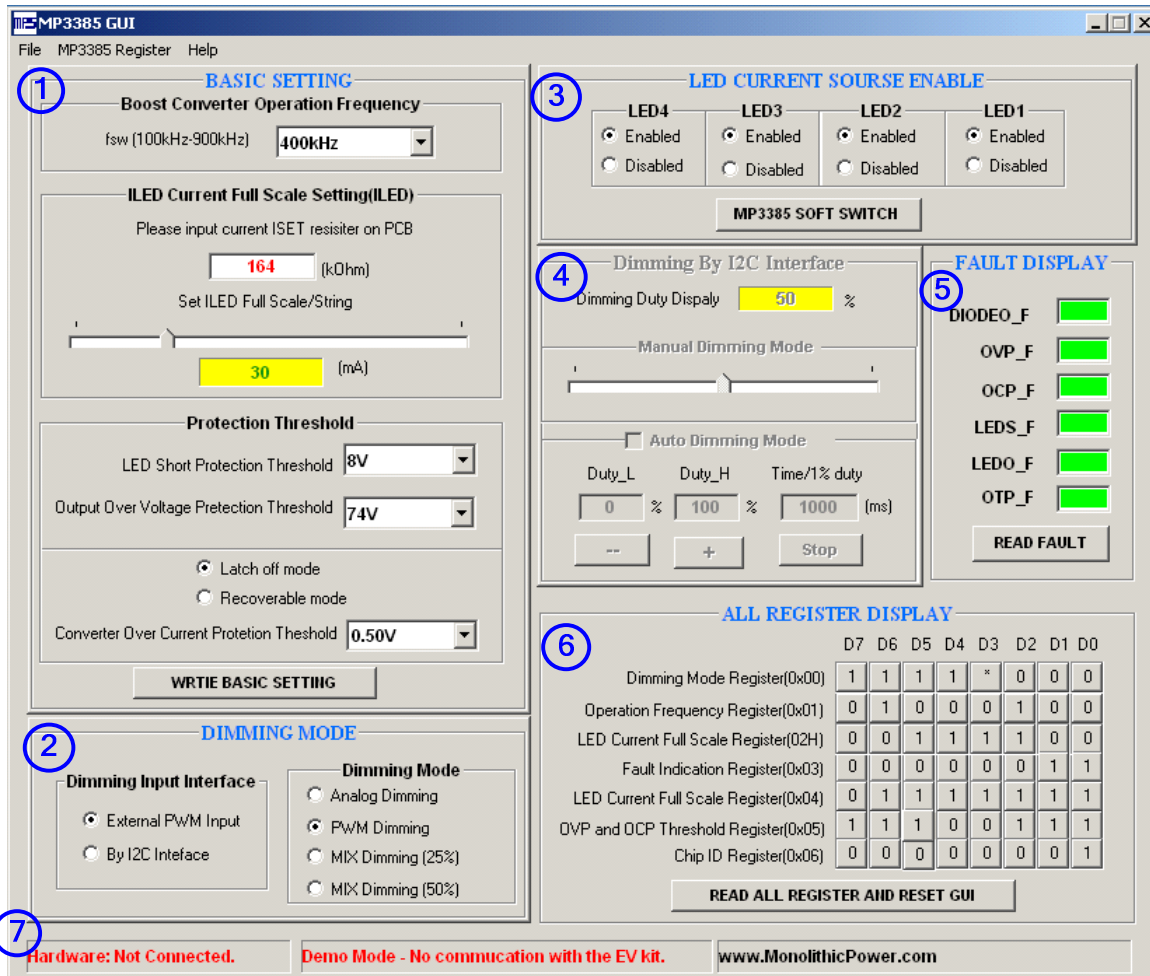

Figure 2 — MP3385 GUI

For part 7, only when it's displayed that "Hardware: connected. Demo Mode-connection with the EV kit." in blue at bottom left of GUI, click button operation is effective. Otherwise check the software and hardware driver again until it's connected.

For part 1, switching frequency and protection threshold can be changed through the drop-down boxes. Maximum current amplitude can be changed through the slide. Write all the above data by clicking button "WRITE BASIC SETTING"

For part 2, dimming mode can be changed by radio button.

For part 3, disable the unused LED string by radio button "LED1, LED2, LED3 and LED4", Write data by clicking button "MP3385 SOFTWARE SWITCH"

For part 4, dimming duty in internal dimming mode can be changed by dragging the slide. Another way, sweep the dimming duty from low to high by 1% step. Sweep ceases when click "stop" button.

For part 5, reading current fault when click the button "READ BUTTON".

For part 6, reading all register of MP3385 when click button "READ ALL REGISTER AND RESET GUI".

Part 6 shows current value of register and the whole GUI will conform to current register.

NOTICE: The information in this document is subject to change without notice. Please contact MPS for current specifications. Users should warrant and guarantee that third party Intellectual Property rights are not infringed upon when integrating MPS products into any application. MPS will not assume any legal responsibility for any said applications.