



The Future of Analog IC Technology®

EV3213DH-00B

700KHz/1.3MHz Boost Converter with a 3.5A Switch Evaluation Board

DESCRIPTION

The EV3213DH-00B is a Low Noise Block (LNB) power supply evaluation board for the MP3213. It is configured to provide a digitally switchable 13.2V or 19.5V output at up to 0.5A from a 12V input. The output is set to 13.2V when EN2 is low and 19.2V when EN2 is high. The circuit also provides output disconnect when EN1 is low and overload and short circuit protection.

The high switching frequency (700KHz or 1.3MHz) of the MP3213 allows for smaller external components, producing a compact solution for a wide range of load currents. Two user-selectable frequency options offer flexibility for easy filtering and low noise. The PCB heatsink with the exposed pad improves thermal performance and efficiency at medium to heavy loads.

FEATURES

- Pin Selectable 700KHz or 1.3MHz Fixed Switching Frequency
- 19.5V at 500mA from 12V Input
- Output Disconnect when EN1 is Low
- Overload and Short Circuit Protection
- Fully Assembled and Tested

APPLICATIONS

- Low Noise Blocks (LNBs) in Satellite Receivers

"MPS" and "The Future of Analog IC Technology" are Trademarks of Monolithic Power Systems, Inc.

ELECTRICAL SPECIFICATIONS

Parameter	Symbol	Value	Units
Input Voltage	V _{IN}	12	V
Frequency Select	f _{SEL}	700	KHz
Output Current	I _{OUT}	0.5	A
Output Voltage	V _{OUT}	13.2 or 19.5	V

EV3213DH-00B EVALUATION BOARD



(L x W x H) 2.5" x 2.4" x 0.5"
(6.3cm x 6.1cm x 1.1cm)

EV3213DH-00B	MP3213DH
--------------	----------

Board Number	MPS IC Number
--------------	---------------

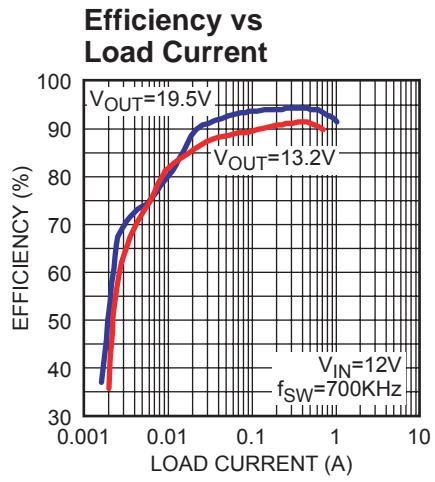

EVALUATION BOARD SCHEMATIC

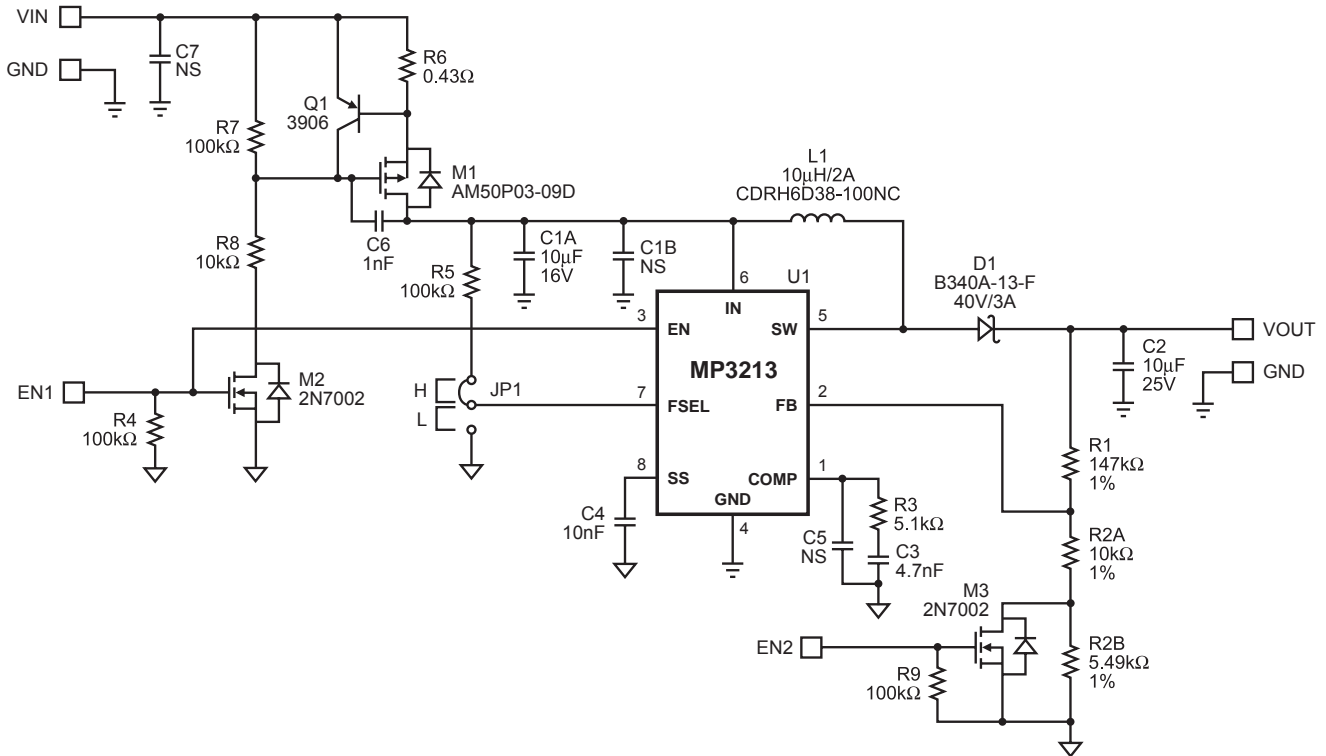

EV3213DH-00B BILL OF MATERIALS

Qty	Ref	Value	Description	Package	Manufacturer P/N
1	C1A	10μF	Ceramic Capacitor, X7R, 16V	1210	TDK: C3225X7R1C106M
3	C1B, C5, C7		Not Stuffed		
1	C2	10μF	Ceramic Capacitor, X7R, 25V	1210	TDK: C3225X7R1E106M
1	C3	4.7nF	Ceramic Capacitor, X7R, 50V	0603	TDK: C1608X7R1H472K
1	C4	10nF	Ceramic Capacitor, X7R, 50V	0603	TDK: C1608X7R1H103K
1	C6	1nF	Ceramic Capacitor, X7R, 50V	0603	TDK: C1608X7R1H102K
1	D1		Diode Schottky, 40V, 3A	SMA	Diodes Inc: B340A-13-F
1	JP1		Connector, 3-Pin, 0.100"		Any: Any
1	L1	10μH	Inductor, 2A	SMD	Sumida: CDRH6D38-100NC
1	M1		MOSFET, P-CH	D-Pak	Analog Power: AM50P03-09D

EV3213DH-00B BILL OF MATERIALS

Qty	Ref	Value	Description	Package	Manufacturer P/N
2	M2, M3		MOSFET, N-CH	SOT-23	Diodes Inc: 2N7002-7-F
1	Q1		Transistor, PNP, 40V, 200mA	SOT-23	Fairchild: MMBT3906
1	R1	147k Ω	Resistor, 1%	0603	Panasonic: ERJ-3EKF1473V
1	R2A	10k Ω	Resistor, 1%	0603	Panasonic: ERJ-3EKF1002V
1	R2B	5.49k Ω	Resistor, 1%	0603	Panasonic: ERJ-3EKF5491V
1	R3	5.1k Ω	Resistor, 5%	0603	Panasonic: ERJ-3GEYJ512V
4	R4, R5, R7, R9	100k Ω	Resistor, 5%	0603	Panasonic: ERJ-3GEYJ104V
1	R6	0.43 Ω	Resistor, 1%	2512	Panasonic: ERJ-1TRQFR43U
1	R8	10k Ω	Resistor, 5%	0603	Panasonic: ERJ-3GEYJ103V
1	U1		DC-DC Converter	MSOP-8	MPS: MP3213DH

TYPICAL PERFORMANCE CURVES

$V_{IN} = 12V$, $f_{SW} = 700KHz$, $T_A = +25^{\circ}C$, unless otherwise noted.

Steady State Operation

$V_{OUT} = 13.2V$, $I_{OUT} = 0.5A$

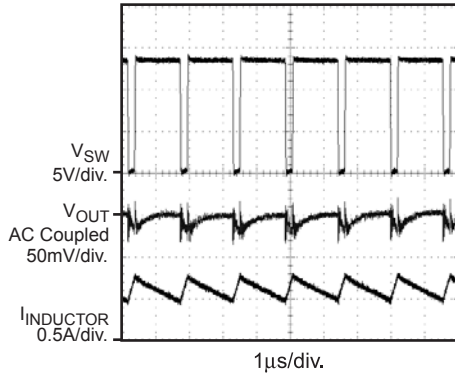

Steady State Operation

$V_{OUT} = 19.5V$, $I_{OUT} = 0.5A$

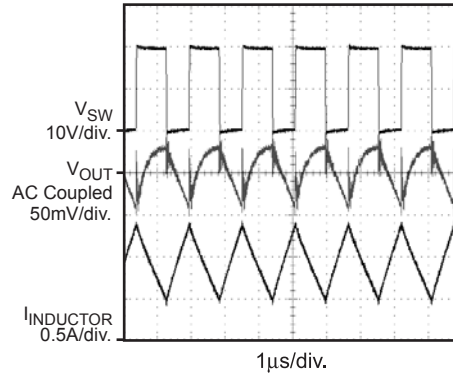

Load Transient Response

$V_{OUT} = 13.2V$, $I_{OUT} = 0.1A - 0.5A$

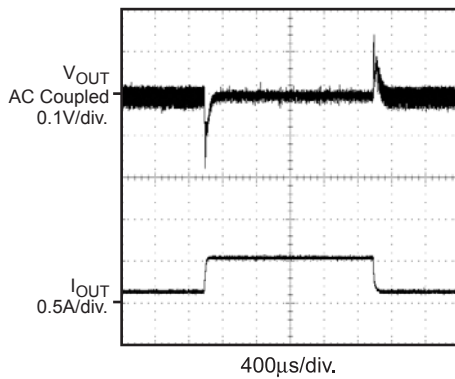

Load Transient Response

$V_{OUT} = 19.5V$, $I_{OUT} = 0.1A - 0.5A$

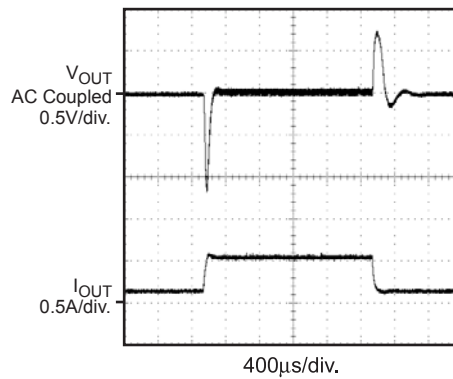

Startup into No Load

$V_{OUT} = 13.2V$, $I_{OUT} = 0A$

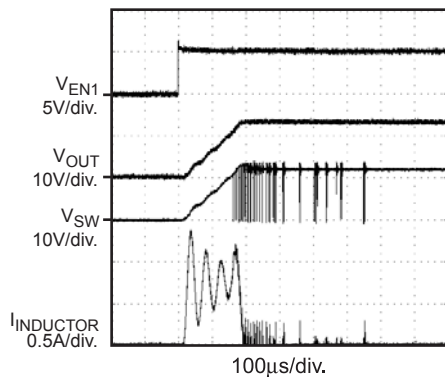

Startup into No Load

$V_{OUT} = 19.5V$, $I_{OUT} = 0A$

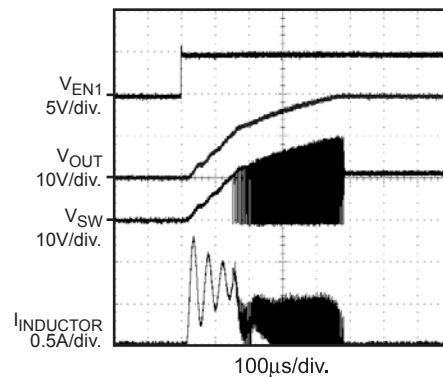

TYPICAL PERFORMANCE CURVES (continued)

$V_{IN} = 12V$, $f_{SW} = 700KHZ$, $T_A = +25^{\circ}C$, unless otherwise noted.

Startup into Load
 $V_{OUT} = 13.2V$, $R_{OUT} = 26\Omega$

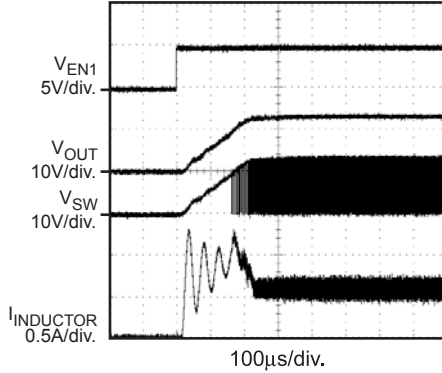

Startup into Load
 $V_{OUT} = 19.5V$, $R_{OUT} = 39\Omega$

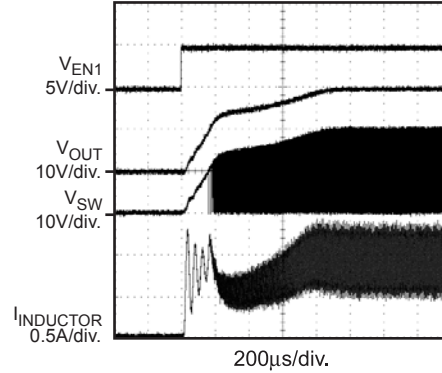

Overload and Short Circuit Protection
 Protection Circuit Activates, EN2 = L

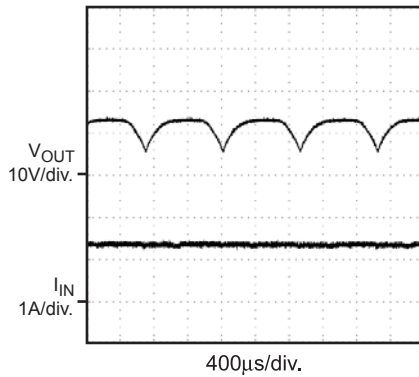

Overload and Short Circuit Protection
 Protection Circuit Activates, EN2 = H

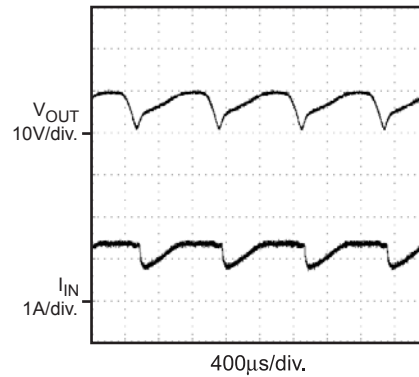

PRINTED CIRCUIT BOARD LAYOUT

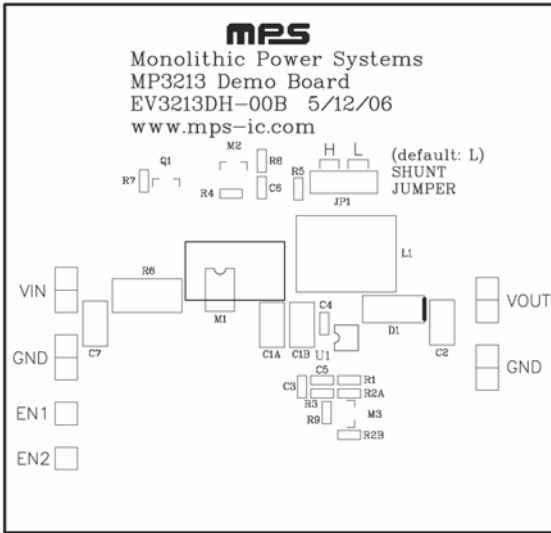

Figure 1—Top Silk Layer

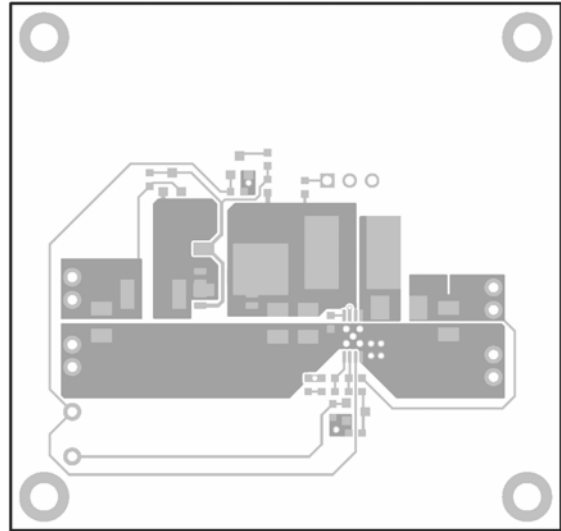

Figure 2—Top Layer

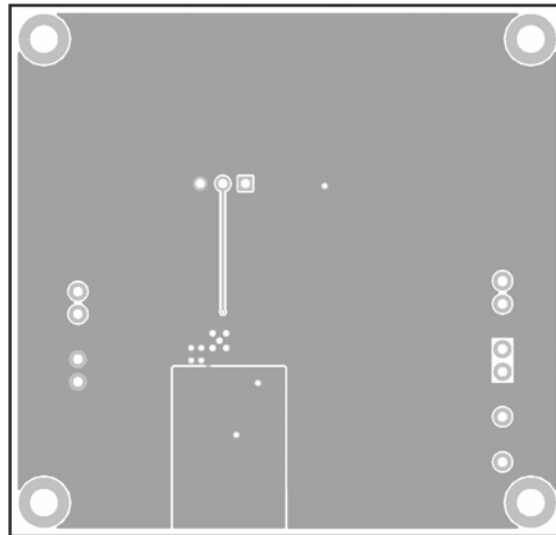

Figure 3—Bottom Silk Layer

QUICK START GUIDE

The output voltage of this board is set to either 13.2V (EN2 = low) or 19.5V (EN2 = high). The board layout accommodates most commonly used inductors and output capacitors.

1. Preset Power Supply to 12V.
2. Turn Power Supply off.
3. Place jumper J1 at the H position for 1.3MHz operation, or at the L position for 700KHz operation (the inductor may need to be adjusted accordingly). 700KHz is recommended due to small duty cycle operation at 13.2V output.
4. Connect the power supply terminals to:
 - Positive (+): VIN
 - Negative (-): GND
5. Connect the load to:
 - Positive (+): VOUT
 - Negative (-): GND
6. Turn on the power supply after making connections.
7. The MP3213 is enabled on the evaluation board once EN1 is pulled high with another power supply set between 1.5V and 6V. To disable the MP3213, disconnect EN1.
8. The output voltage V_{OUT} is set by the resistors R1, R2A and R2B:

$$V_{OUT} = \left(\frac{R1}{R2A + R2B} + 1 \right) \times V_{FB} \text{ if EN2 is low}$$

$$V_{OUT} = \left(\frac{R1}{R2A} + 1 \right) \times V_{FB} \text{ if EN2 is high}$$

NOTICE: The information in this document is subject to change without notice. Please contact MPS for current specifications. Users should warrant and guarantee that third party Intellectual Property rights are not infringed upon when integrating MPS products into any application. MPS will not assume any legal responsibility for any said applications.