

DESCRIPTION

The EV2499M-QB-00A is an evaluation board for MP2499M, a synchronous rectified, step-down module converter with built-in power MOSFETs.

The evaluation board can deliver a 3A max continuous output current with excellent load and line regulation over a wide input supply range.

Current-mode operation provides fast transient response and eases loop stabilization.

Full protection features include over-current protection and thermal shut down.

The MP2499M requires a minimal number of readily-available standard external components, and is available in a space-saving QFN-13 (2.5mmx3mm) package.

ELECTRICAL SPECIFICATION⁽¹⁾

Parameter	Symbol	Value	Units
Input Voltage	V _{IN}	12	V
Output Voltage	V _{OUT}	5	V
Output Current	I _{OUT}	2.4	A

Notes:

1) For different input, output spec, please refer to APPLICATION and TYPICAL APPLICATION CIRCUITS section on datasheet to choose proper values

FEATURES

- Wide 5V to 36V Continuous Operating Input Range
- 85mΩ/55mΩ Low R_{DS(ON)} Internal Power MOSFETs
- High-Efficiency Synchronous Mode Operation
- Default 270kHz Switching Frequency
- Synchronizes to a 200kHz to 2.4MHz External Clock
- Internal Soft-Start
- Output Line Drop Compensation
- Accurate Continuous Output Current Limit with External Resistor
- OCP Protection and Hiccup
- Thermal Shutdown
- Output Adjustable from 0.8V
- Available in an QFN-13 (2.5mmx3mm)

APPLICATIONS

- USB Dedicated Charging Ports (DCP)
- Automotive Cigarette Lighter Adapters
- USB Chargers
- USB PD Applications

All MPS parts are lead-free, halogen free, and adhere to the RoHS directive. For MPS green status, please visit MPS website under Quality Assurance. "MPS" and "The Future of Analog IC Technology" are Registered Trademarks of Monolithic Power Systems, Inc.

EV2499M-QB-00A EVALUATION BOARD

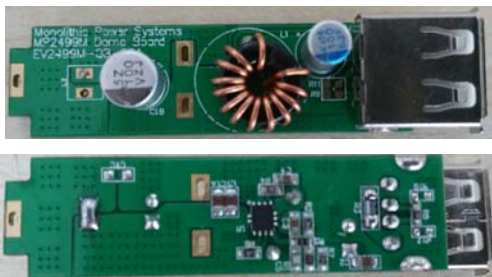

(L x W x H) 5.5cm x 1.4cm x 1.1cm
(Two layer PCB)

Board Number	MPS IC Number
EV2499M-QB-00A	MP2499MGQB

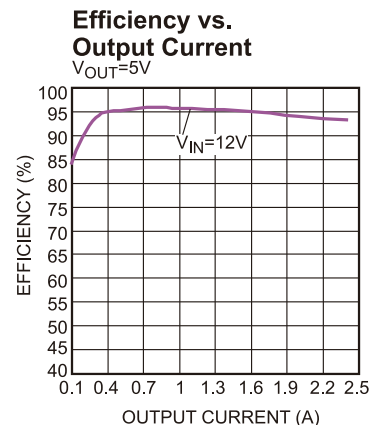

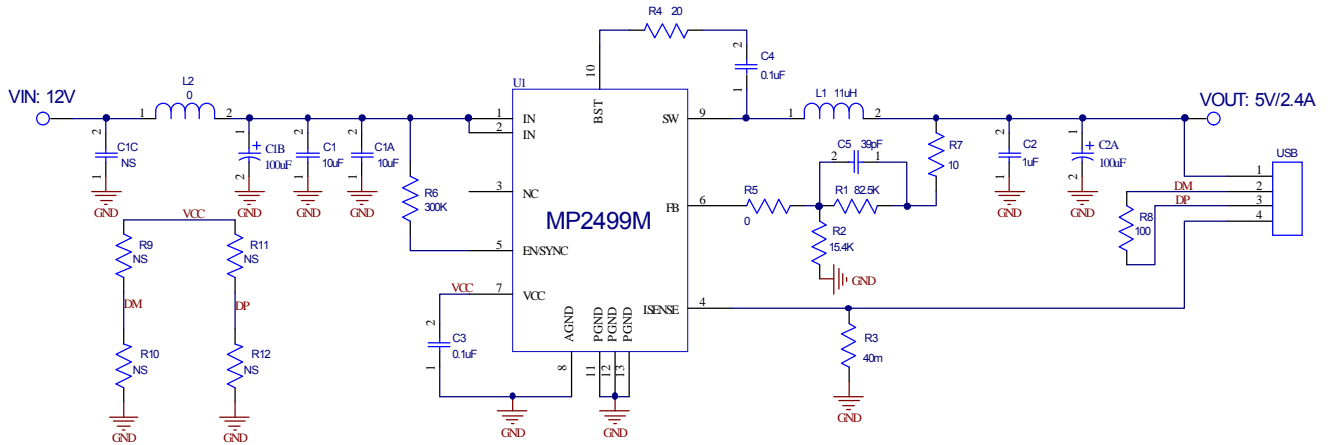
EVALUATION BOARD SCHEMATIC

EV2499M-QB-00A BILL OF MATERIALS

Qty	Ref	Value	Description	Package	Manufacturer	Manufacturer P/N
2	C1, C1A	10µF	Ceramic Cap, 50V,X5R	0805	muRata	GRM21BR61H106KE43L
1	C1B	100µF	Electrolytic capacitor, 35V, 160mΩ ESR.	DIP	Chemi-Con	EMZJ35ADA101MF80G
1	C2	1µF	Ceramic Cap,6.3V,X7R	0805	muRata	GRM21BR71A105KA01L
1	C2A	100µF	Polymer capacitor, 6.3V, 10mΩ ESR.	DIP	Chemi-Con	APSK6R3ELL101ME08S
2	C3, C4	0.1µF	Ceramic Cap, 50V,Y5V	0603	TDK	C1608Y5V1H104Z
1	C5	39pF	Ceramic Cap, 50V,X7R	0603	muRata	GRM1885C1H390JA01D
0	C1C	NS				
1	R1	82.5k	Thick Film Res, 1%	0603	Any	
1	R2	15.4k	Thick Film Res, 1%	0603	Any	
1	R3	40m		1206	Any	
1	R4	20	Thick Film Res, 1%	0603	Any	
1	R5	0	Thick Film Res, 1%	0603	Any	
1	R6	300k	Thick Film Res, 5%	0603	Any	
1	R7	10	Thick Film Res, 1%	0603	Any	
1	R8	100	Thick Film Res, 1%	0603	Any	
0	R9,R10, R11,R12	NS	Thick Film Res, 1%	0603	Any	
1	L1	11µH	Toroidal Inductor	DIP	UEC	WL-801
0	L2	0	Shorted by wire			
1	U1	MPS	Step-Down Converter	QFN-13 (2.5mmx3 mm)	MPS	MP2499MGQB
1	USB	USB	Single USB port	Tray	Würth	61400416021

TYPICAL PERFORMANCE CHARACTERISTICS

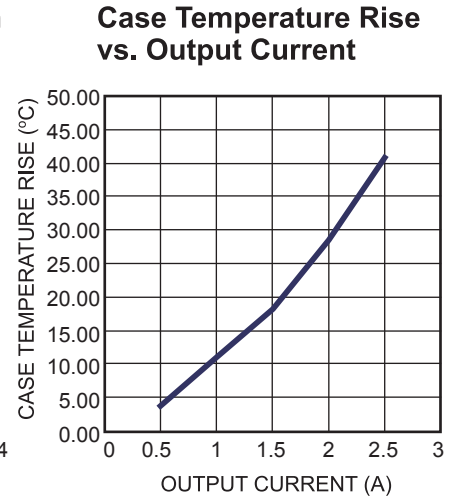
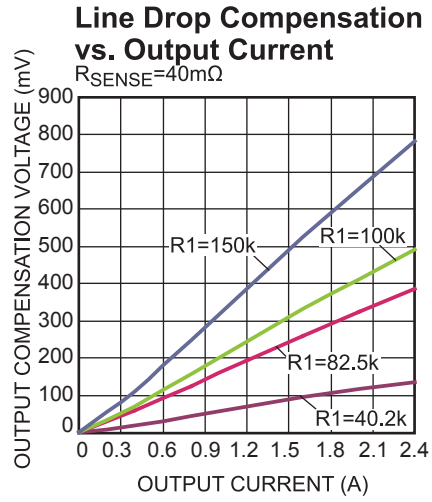
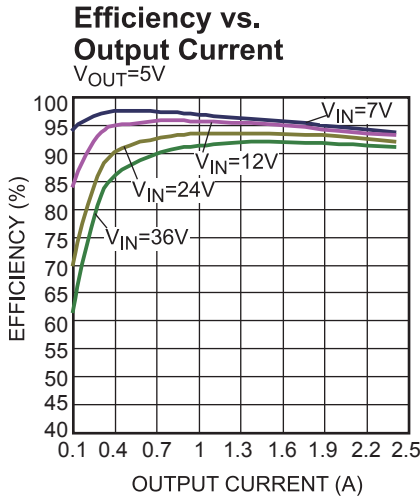
$V_{IN} = 12V$, $V_{OUT} = 5V$, $L = 11\mu H$, $T_A = +25^\circ C$, unless otherwise noted.



TYPICAL PERFORMANCE CHARACTERISTICS (continued)

$V_{IN} = 12V$, $V_{OUT} = 5V$, $L = 11\mu H$, $T_A = +25^\circ C$, unless otherwise noted.

Start-Up through V_{IN}
 $I_{OUT} = 0A$

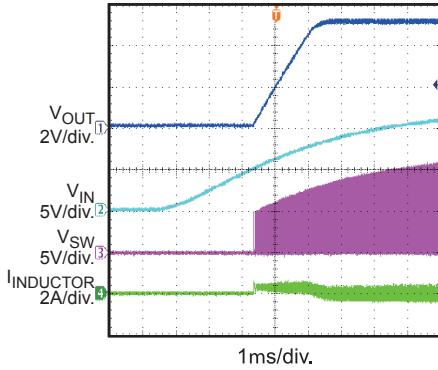

Start-Up through V_{IN}
 $I_{OUT} = 2.4A$

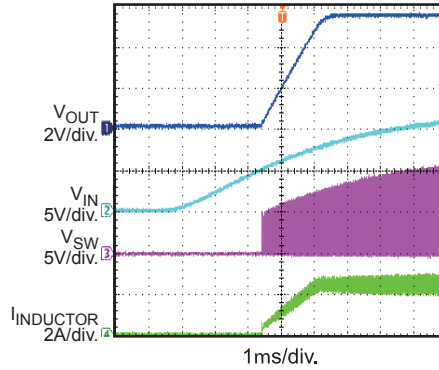

Shutdown through V_{IN}
 $I_{OUT} = 0A$

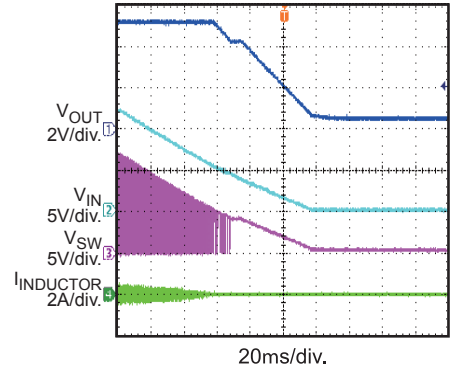

Shutdown through V_{IN}
 $I_{OUT} = 2.4A$

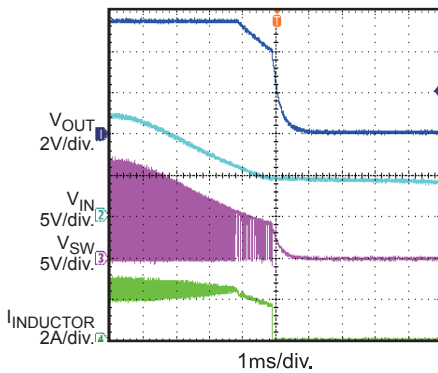

Start-Up through EN
 $I_{OUT} = 0A$

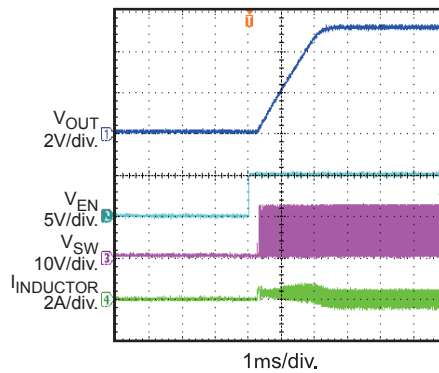

Start-Up through EN
 $I_{OUT} = 2.4A$

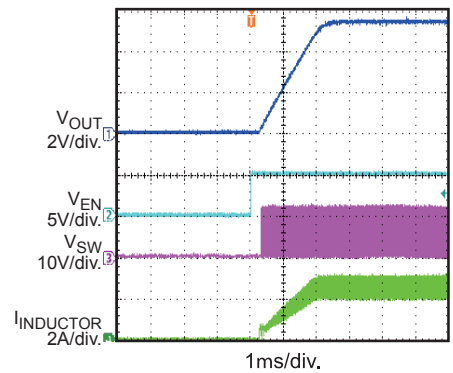

Shutdown through EN
 $I_{OUT} = 0A$

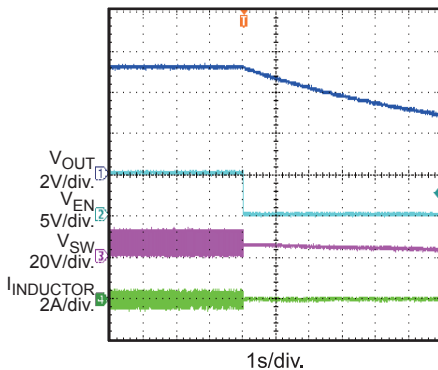

Shutdown through EN
 $I_{OUT} = 2.4A$

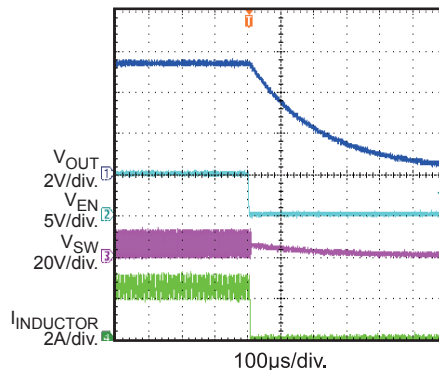

Output Voltage Ripple
 $I_{OUT} = 0A$

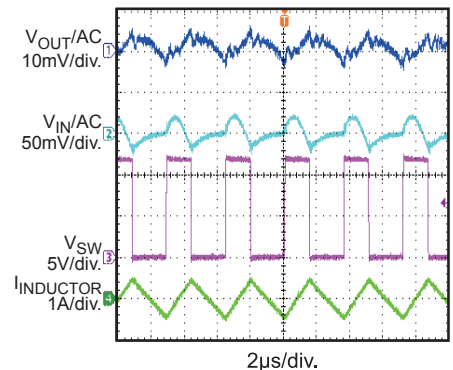

TYPICAL PERFORMANCE CHARACTERISTICS *(continued)*

$V_{IN} = 12V$, $V_{OUT} = 5V$, $L = 11\mu H$, $T_A = +25^\circ C$, unless otherwise noted.

Output Voltage Ripple

$I_{OUT} = 2.4A$

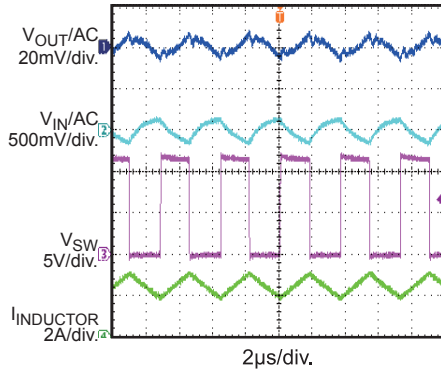

Load Transient Response

$I_{OUT} = 1.2A-2.4A$

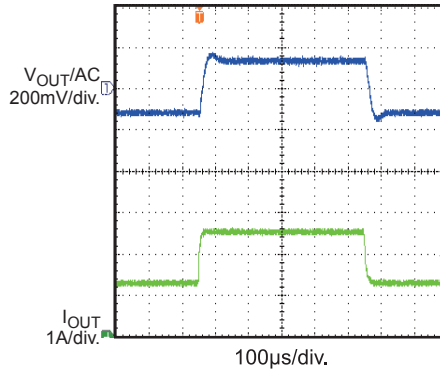

Short Circuit Entry

$I_{OUT} = 0A$

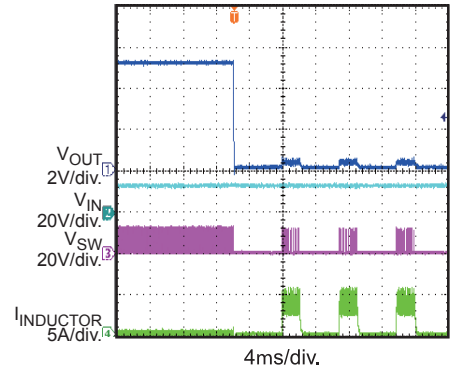

Short Circuit Recovery

$I_{OUT} = 0A$

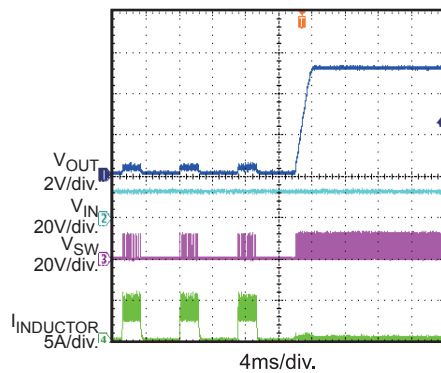

PRINTED CIRCUIT BOARD LAYOUT

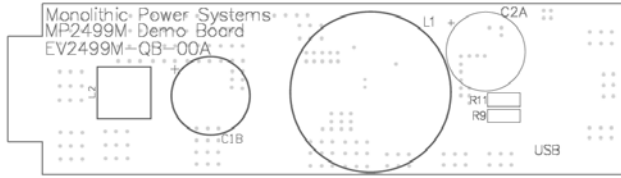

Figure 1—Top Silk Layer

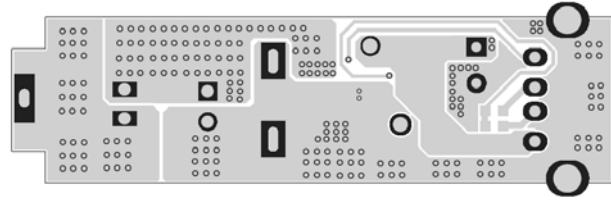

Figure 2—Top Layer

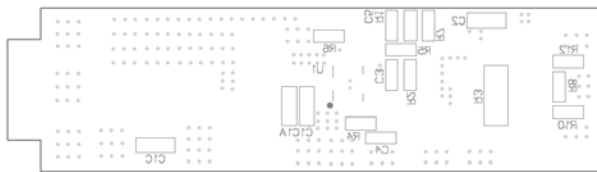

Figure 3—Bottom Silk Layer

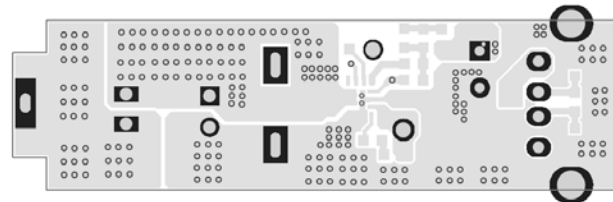

Figure 4—Bottom Layer

QUICK START GUIDE

1. Connect the positive and negative terminals of the load to the VOUT and GND pins, respectively.
2. Preset the power supply output between 6.5V and 36V, and then turn off the power supply.
3. Connect the positive and negative terminals of the power supply output to the VIN and GND pins, respectively.
4. Turn the power supply on. The board will automatically start up.
5. To use the Enable function, apply a digital input to the EN/SYNC pin. Drive EN higher than 1.4V to turn on the converter, or less than 1.25V to turn it off.
6. To use the external synchronous function to adjust the switching frequency, apply an external clock signal to EN/SYNC pin.

NOTICE: The information in this document is subject to change without notice. Please contact MPS for current specifications. Users should warrant and guarantee that third party Intellectual Property rights are not infringed upon when integrating MPS products into any application. MPS will not assume any legal responsibility for any said applications.