

DESCRIPTION

The EV2312-Q-00A is an evaluation board for the MP2312, a high efficiency monolithic synchronous step-down converter.

The Evaluation Board can deliver 2.1A continuous load current from a 6V to 24V input with excellent load and line regulation.

Constant-On-Time (COT) control mode provides fast transient response and eases loop stabilization.

The Evaluation Board can be turned on or shut down via a remote ON/OFF input that is reference to ground. This input is compatible with popular logic devices.

ELECTRICAL SPECIFICATION

Parameter	Symbol	Value	Units
Input Voltage	V_{IN}	6 – 24	V
Output Voltage	V_{OUT}	5	V
Output Current	I_{OUT}	2.1	A
Switching Frequency	f_{SW}	500	kHz

FEATURES

- Wide 6V to 24V Operating Input Range
- 2.1A Continuous Output Current
- Low $R_{DS(ON)}$ Internal Power MOSFETs
- Proprietary Switching Loss Reduction Technique
- 1% Reference Voltage
- Internal Soft Start
- Output Discharge
- 500kHz Switching Frequency
- OCP, OVP, UVP Protection and Thermal Shutdown
- Available in a QFN3x3 package

APPLICATIONS

- Laptop Computer
- Tablet PC
- Networking Systems
- Personal Video Recorders
- Flat Panel Television and Monitors
- Distributed Power Systems

All MPS parts are lead-free and adhere to the RoHS directive. For MPS green status, please visit MPS website under Products, Quality Assurance page. "MPS" and "The Future of Analog IC Technology", are Registered Trademarks of Monolithic Power Systems, Inc.

EV2312-Q-00A EVALUATION BOARD



(L x W x H) 8.55cm x 8.55cm x 1.6cm

Board Number	MPS IC Number
EV2312-Q-00A	MP2312GQ

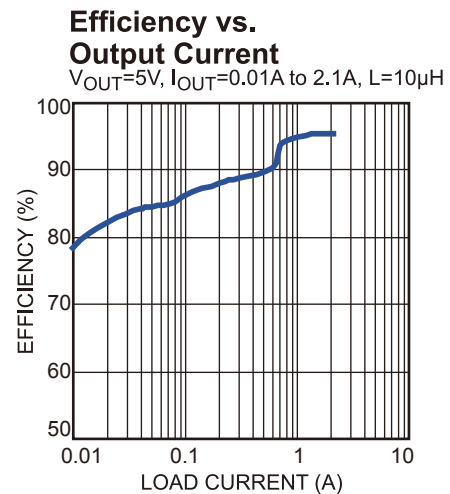

EVALUATION BOARD SCHEMATIC

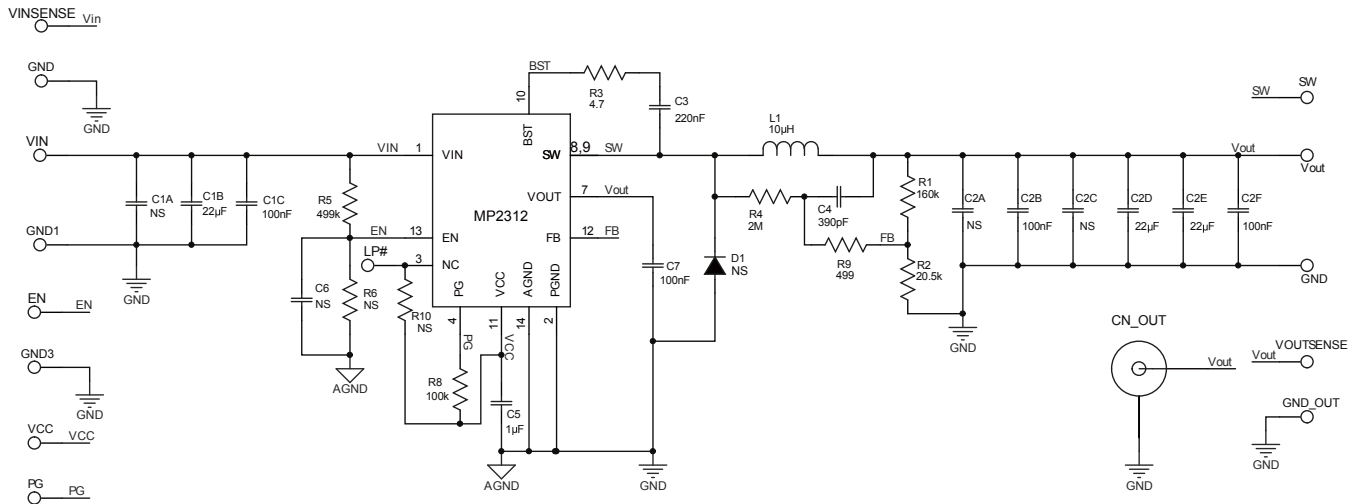

EV2312-Q-00A BILL OF MATERIALS

Qty.	Ref	Value	Description	Package	Manufacture	Manufacture_PN
1	C1B	22 μ F	Ceramic Capacitor;25V;X5R;1210	1210	muRata	GRM32ER61E226KE15L
2	C1C,C2B	100nF	Ceramic Capacitor;50V;X7R;0603	0603	muRata	GRM188R71H104KA93D
0	C1A,C2A,C2C,C6	NS				
2	C2D,C2E	22 μ F	Ceramic Capacitor;6.3V;X5R;1206	1206	muRata	GRM31CR60J226KE19
2	C2F, C7	100nF	Ceramic Capacitor;16V;X7R;0603	0603	muRata	GRM188R71C104KA01D
1	C3	220nF	Ceramic Capacitor;16V;X7R;0603	0603	muRata	GRM188R71C224KA01
1	C4	390pF	Ceramic Capacitor;50V;X7R;0603	0603	muRata	GRM1885C1H391JA01
1	C5	1 μ F	Ceramic Capacitor;10V;X5R;0603	0603	muRata	GRM188R71A105KA61D
0	D1	NS	Schottky Diode;40V;0.5A	SOD-123		
1	L1	10 μ H	Inductor;10 μ H;25m Ω ,4A	SMD	Würth	7447715100
1	R1	160k	Film Resistor;1%	0603	Yageo	RC0603FR-07160KL
1	R2	20.5k	Film Resistor;1%	0603	Yageo	RC0603FR-0720K5L
1	R3	4.7	Film Resistor;5%	0603	Yageo	RC0603JR-074R7L
1	R4	2M	Film Resistor;1%	0603	Yageo	RC0603FR-072ML
0	R6	NS	Film Resistor;1%	0603		
1	R5	499k	Film Resistor;1%	0603	Yageo	RC0603FR-07499KL
2	R8	100k	Film Resistor;1%	0603	Yageo	RC0603FR-07100KL
1	R9	499	Film Resistor;1%	0603	Yageo	RC0603FR-07499RL
0	R10	NS	Film Resistor;5%	0603		
1	U1		Step Down Converter	QFN 3x3	MPS	MP2312GQ

EVB TEST RESULTS

Performance waveforms are tested on the EV2312-Q-00A.

$V_{IN} = 19V$, $V_{OUT} = 5V$, $L = 10\mu H$, $T_A = 25^\circ C$, unless otherwise noted.

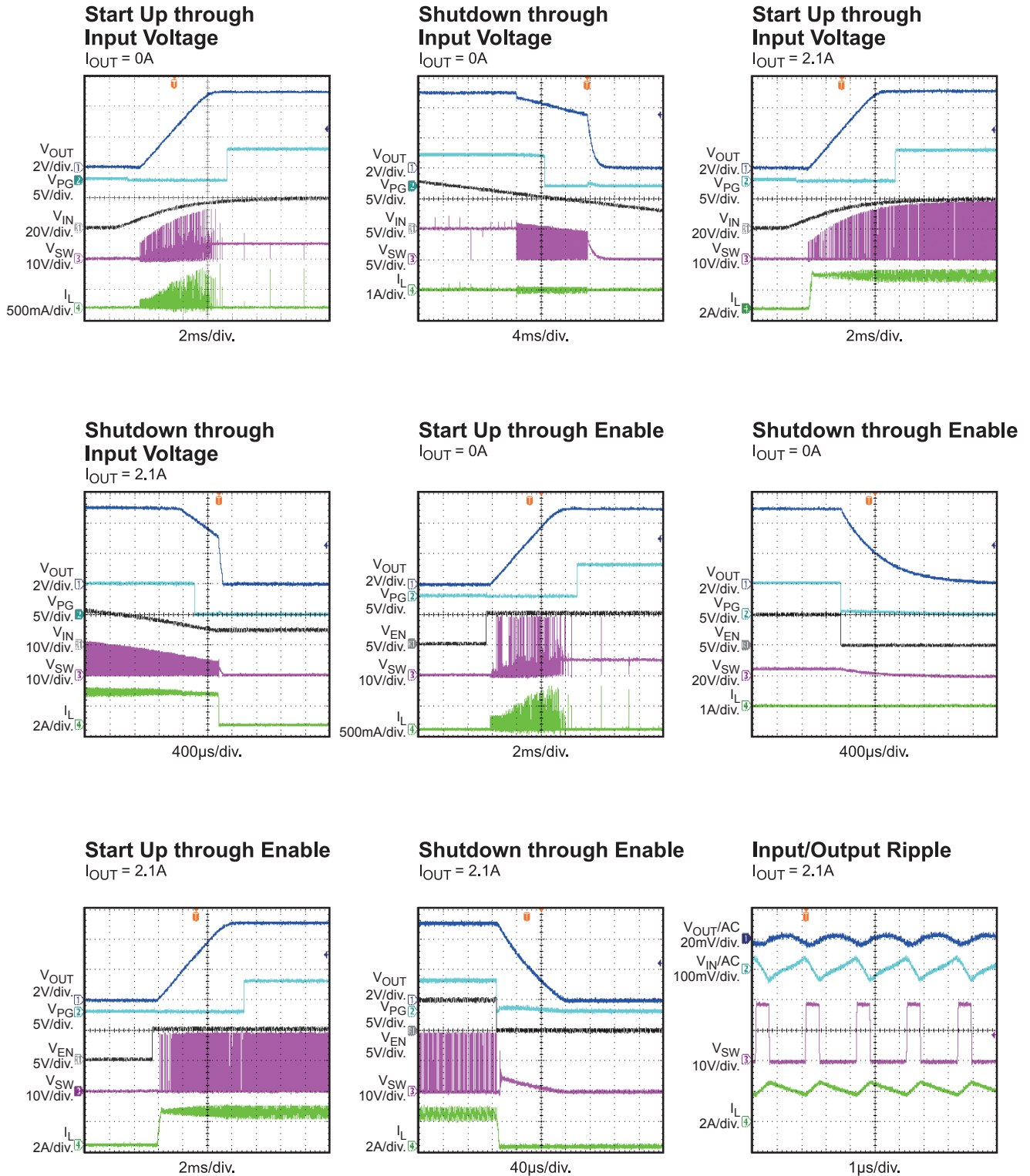

EVB TEST RESULTS *(continued)*

Performance waveforms are tested on the EV2312-Q-00A.

$V_{IN}=19V$, $V_{OUT}=5V$, $L=10\mu H$, $T_J=+25^\circ C$, unless otherwise noted.

Input/Output Ripple

$I_{OUT} = 0A$

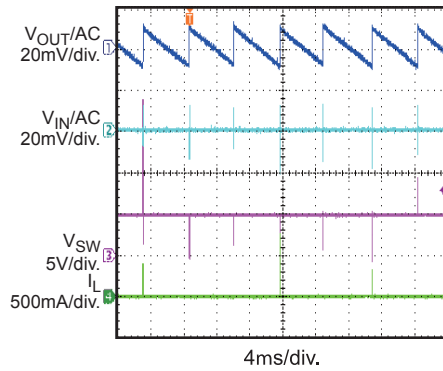

Transient Response

$I_{OUT} = 1.05A - 2.1A, 2.5A/\mu s$

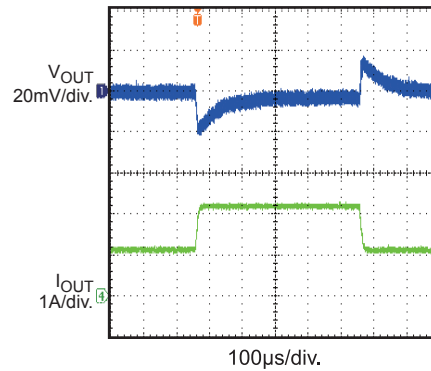

Short Circuit Entry

$I_{OUT} = 0A$

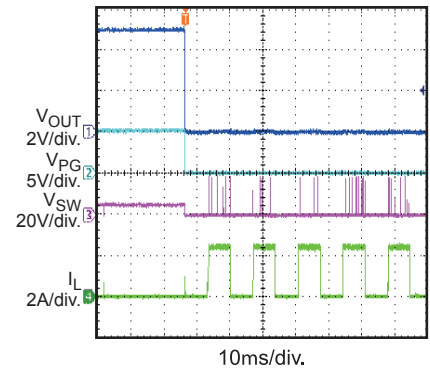

Short Circuit Recovery

$I_{OUT} = 0A$

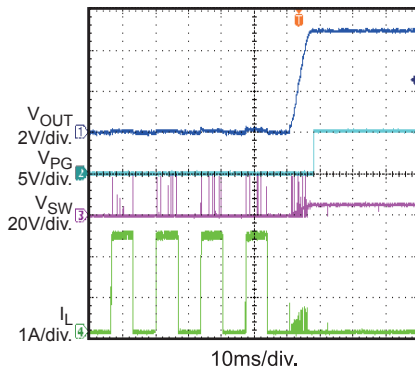

Short Circuit Steady State

$I_{OUT} = 0A$

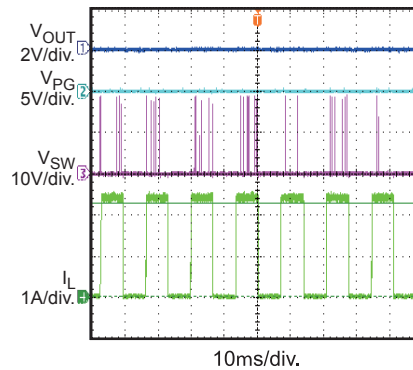

PRINTED CIRCUIT BOARD LAYOUT

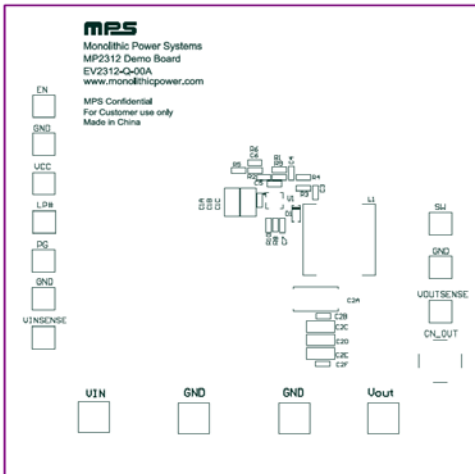

Figure 1: Top Silk Layer

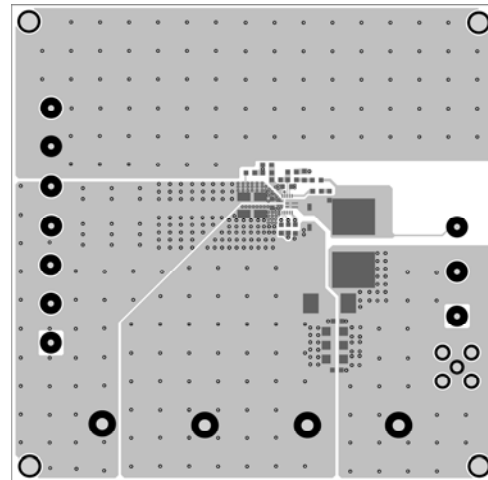

Figure 2: Top Layer

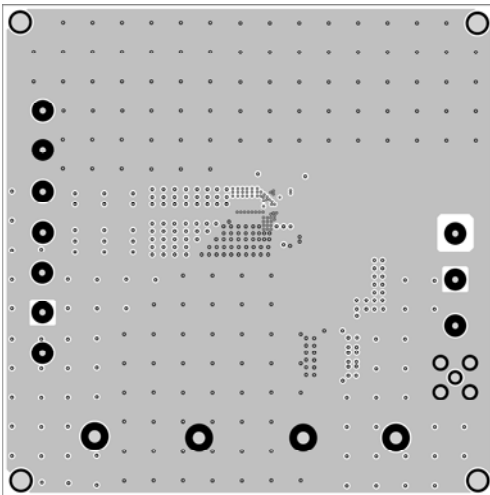

Figure 3: Inner Layer1

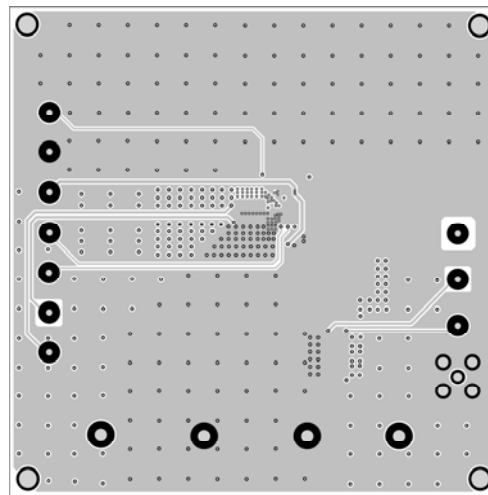

Figure 4: Inner Layer2

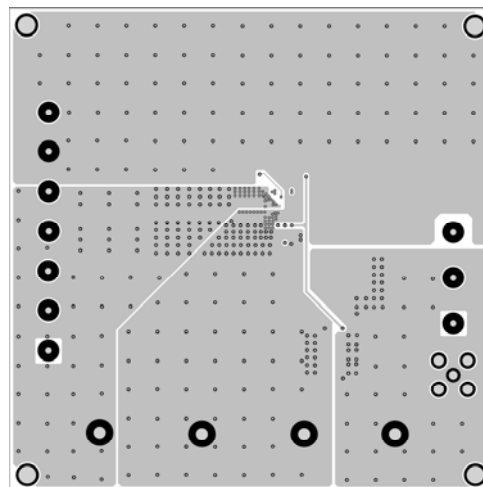

Figure 5: Bottom Layer

QUICK START GUIDE

1. Connect the positive and negative terminals of the load to the VOUT and GND pins respectively.
2. Preset the output of power supply between 6V and 24V, and then turn off the power supply.
3. Connect the positive and negative terminals of the power supply output to the VIN and GND pins respectively:
4. Turn the power supply on. The MP2312GQ will automatically start up.
5. To use the Enable function, apply a digital input to the EN pin. Drive EN higher than 2V to turn on the regulator or less than 0.4V to turn it off.
6. Use R1 and R2 to set the output voltage within $V_{FB}=0.604V$. Follow the Application information section in the device datasheet to select the proper value of R1, R2, inductor and output capacitor values when output voltage is changed.

NOTICE: The information in this document is subject to change without notice. Please contact MPS for current specifications. Users should warrant and guarantee that third party Intellectual Property rights are not infringed upon when integrating MPS products into any application. MPS will not assume any legal responsibility for any said applications.