

DESCRIPTION

The EV2240-J-00A demonstrates MPS's MP2240, a high-frequency, synchronous, rectified, step-down converter with built-in high-side and low-side power MOSFETs. The MP2240 offers a very compact solution to achieve a 3A continuous output current with excellent load and line regulation over a wide input supply range. The MP2240 has synchronous mode operation for higher efficiency over the output current load range.

Current-mode operation provides fast transient response and eases loop stabilization.

Full protection features includes over-current protection and thermal shutdown.

The MP2240 is available in a space-saving 8-pin TSOT23 package.

ELECTRICAL SPECIFICATION

Parameter	Symbol	Value	Units
Input Voltage	V_{IN}	6 – 16	V
Output Voltage	V_{OUT}	3.3	V
Output Current	I_{OUT}	3	A

FEATURES

- Wide 6V to 16V Operating Input Range
- 80mΩ/30mΩ Low $R_{DS(ON)}$ Internal Power MOSFET
- Proprietary Switching-Loss-Reduction Technique
- High-Efficiency Synchronous Mode Operation
- Default 800kHz Switching Frequency
- AAM Power-Save Mode
- Internal Soft-Start
- OCP Protection and Hiccup
- Thermal Shutdown
- Output Adjustable from 0.8V
- Available in an 8-pin TSOT-23 Package

APPLICATIONS

- Notebook System and I/O Power
- Digital Set-Top Boxes
- Flat-Panel Television and Monitors
- Distributed Power Systems

All MPS parts are lead-free and adhere to the RoHS directive. For MPS green status, please visit MPS website under Quality Assurance. "MPS" and "The Future of Analog IC Technology", are Registered Trademarks of Monolithic Power Systems, Inc.

EV2240-J-00A EVALUATION BOARD



Board Number	MPS IC Number
EV2240-J-00A	MP2240GJ

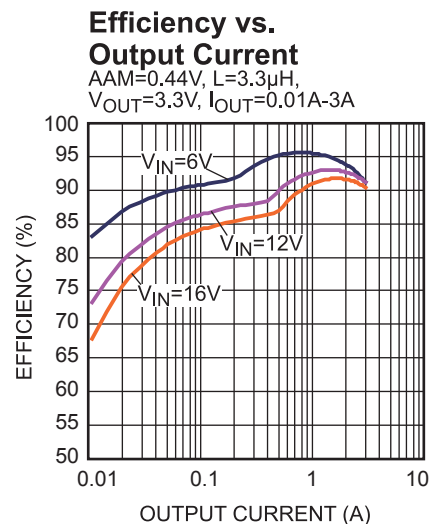

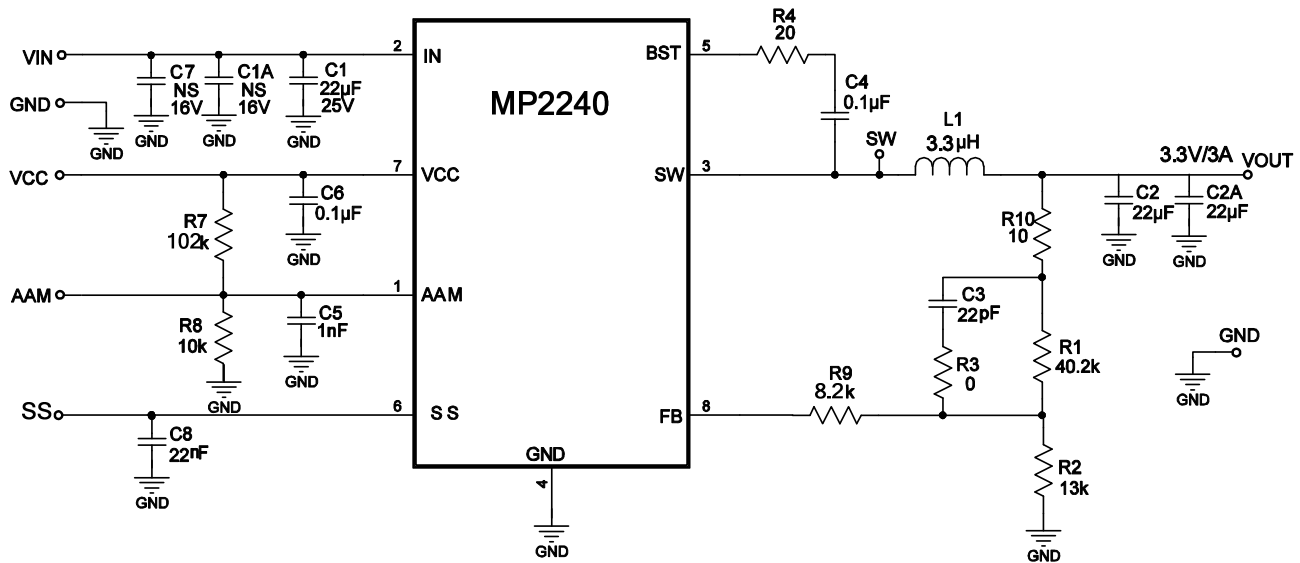
EVALUATION BOARD SCHEMATIC

EV2240-J-00A BILL OF MATERIALS

Qty	Ref	Value	Description	Package	Manufacturer	Manufacturer P/N
1	C1	22 μ F	Ceramic Cap., 25V, 10%, X5R	1206	muRata	GRM31CR61E226KE15L
2	C1A, C7	NS				
2	C2, C2A	22 μ F	Ceramic Cap., 10V, X7R	1206	muRata	GRM21BR60J226ME39L
1	C3	22pF	Ceramic Cap., 50V, C0G	0603	muRata	GRM1885C1H220JA01D
2	C4, C6	0.1 μ F	Ceramic Cap., 16V, X7R	0603	muRata	GRM188R71C104KA01D
1	C5	1nF	Ceramic Cap., 50V, X7R	0603	muRata	GRM188R71H102KA01D
1	C8	22nF	Ceramic Cap, 16V, X7R	0603	muRata	GRM188R71C223KA01D
1	R1	40.2k	Thick Film Res., 1%	0603	ROYAL	RL0603FR-0740K2L
1	R2	13k	Thick Film Res., 1%	0603	ROYAL	RL0603FR-0713KL
1	R3	0 Ω	Thick Film Res., 1%	0603	ROYAL	RL0603L000JT
1	R4	20 Ω	Thick Film Res., 5%	0603	ROYAL	RL0603FR-0720RL
1	R7	102k	Thick Film Res., 1%	0603	ROYAL	RL0603FR-07102KL
1	R8	10k	Thick Film Res., 1%	0603	ROYAL	RL0603FR-0710KL
1	R9	8.2k	Thick Film Res., 1%	0603	ROYAL	RL0603FR-078K2L
1	R10	10 Ω	Thick Film Res., 1%	0603	ROYAL	RL0603FR-0710RL
1	L1	3.3 μ H	Inductor, DCR=9m Ω , Is=8A	SMD	Wurth	744314330
1	U1	MP2240-J	Synchronous Step-Down Convert	TSOT23-8	MPS	MP2240-J

EVB TEST RESULTS

Performance waveforms are tested on the evaluation board.

$V_{IN} = 12V$, $V_{OUT} = 3.3V$, $L = 3.3\mu H$, $T_A = 25^\circ C$, unless otherwise noted.

Input/Output Ripple

$I_{OUT} = 3A$

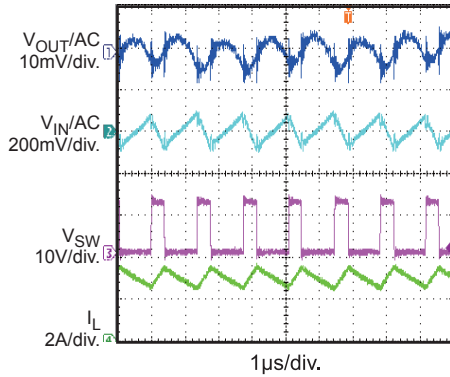

Case Temperature Rise vs. Output Current

$I_{OUT} = 0A-3A$

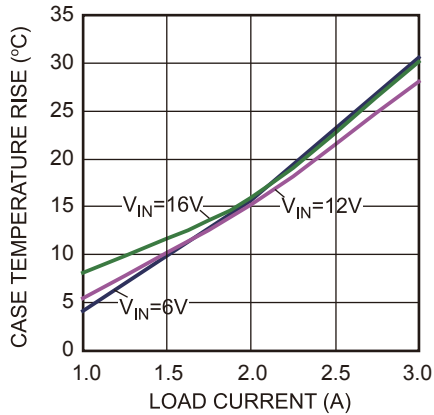

Infrared Thermal Image

$I_{OUT} = 3A$

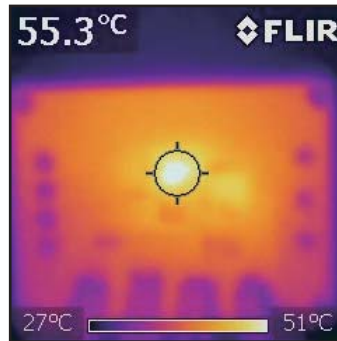

Zoom in

Infrared Thermal Image

$I_{OUT} = 3A$

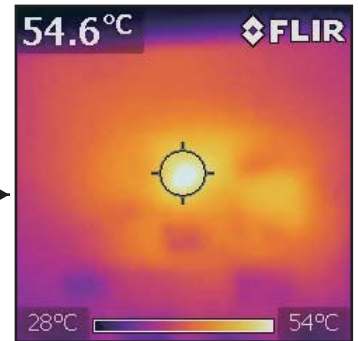

PRINTED CIRCUIT BOARD LAYOUT

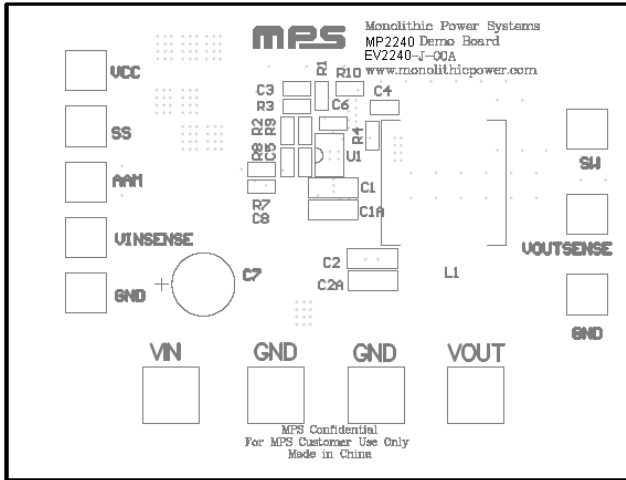

Figure 1—Top Silk Layer

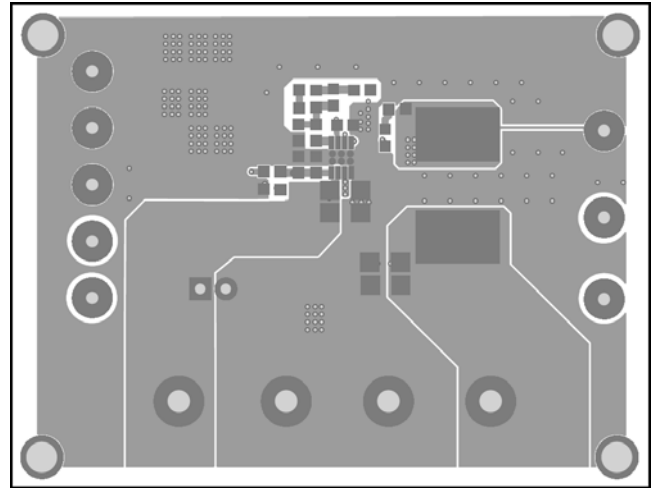

Figure 2—Top Layer

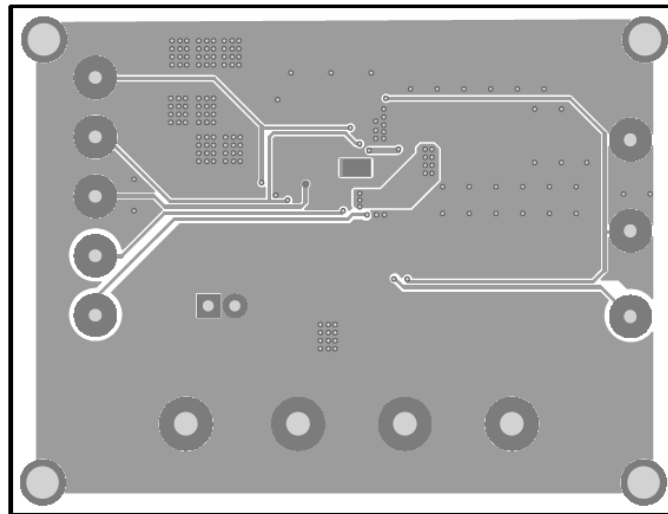

Figure 3—Bottom Layer

QUICK START GUIDE

1. Connect the positive and negative terminals of the load to the VOUT and GND pins, respectively.
2. Preset the power supply output between 6V and 16V, and then turn off the power supply.
3. Connect the positive and negative terminals of the power supply output to the VIN and GND pins, respectively.
4. Turn the power supply on. The board will automatically start up.

NOTICE: The information in this document is subject to change without notice. Please contact MPS for current specifications. Users should warrant and guarantee that third party Intellectual Property rights are not infringed upon when integrating MPS products into any application. MPS will not assume any legal responsibility for any said applications.