

DESCRIPTION

The EV2160-QH-00A is used for demonstrating the performance of MPS's MP2160, a low voltage high switching frequency step-down switcher with built in power MOSFETs. MP2160 provides up to 1.2A peak highly efficient output with constant-on-time control for fast loop response.

MP2160 is ideal for powering portable equipment that runs from a single cell Lithium-ion (Li+) Battery. The output voltage can be regulated as low as 0.6V.

High power efficiency over a wide load range is achieved by scaling down the switching frequency at light load to reduce the switching related loss by constant on time control. Short circuit and thermal shutdown provides reliable, fault-tolerant operation.

MP2160 is available in QFN8 2.0x1.5mm package.

ELECTRICAL SPECIFICATION

Parameter	Symbol	Value	Units
Input Voltage	V_{IN}	2.5– 6	V
Output Voltage	V_{OUT}	1.2	V
Output Current	I_{OUT}	1	A

FEATURES

- Wide 2.5V to 6V Operating Input Range
- Up to 1.2A Peak Output Current
- 17 μ A Quiescent Current
- 100m Ω and 60m Ω Internal Power MOSFET
- 3.5MHz CCM Switching Frequency
- EN and Power Good for Power Sequencing
- Cycle-by-Cycle Over Current Protection
- Short Circuit Protection with Hiccup Mode
- Thermal Shutdown
- Stable with Low ESR Ceramic Output Capacitors
- Internal Soft-Start
- Available in a QFN8 2.0x1.5mm Package

APPLICATIONS

- Wireless Card
- DVD Drivers

All MPS parts are lead-free and adhere to the RoHS directive. For MPS green status, please visit MPS website under Products, Quality Assurance page.

"MPS" and "The Future of Analog IC Technology" are registered trademarks of Monolithic Power Systems, Inc.

EV2160-QH-00A EVALUATION BOARD



Board Number	MPS IC Number
EV2160-QH-00A	MP2160GQH

Efficiency

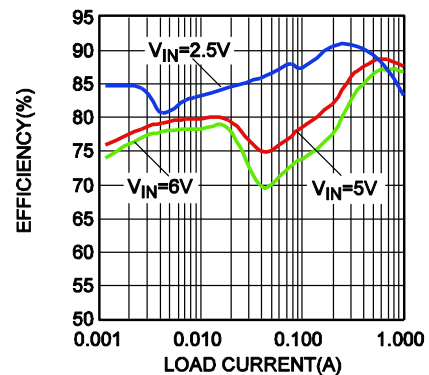

EVALUATION BOARD SCHEMATIC

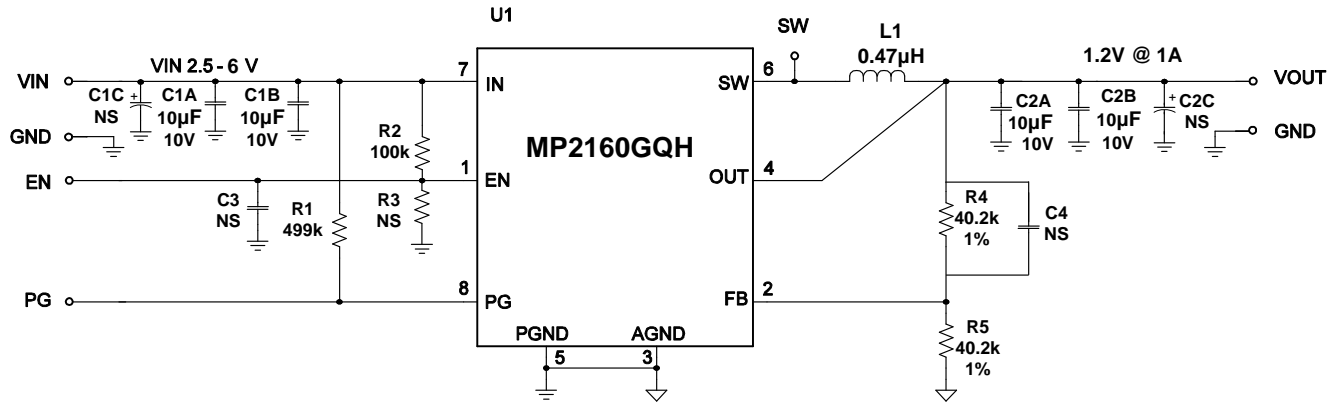

EV2160-QH-00A BILL OF MATERIALS

Qty	RefDes	Value	Description	Package	Manufacturer	Manufacturer P/N
2	C1A,C1B	10µF	Ceramic Cap., 10V, X5R	SM0805	TDK	C2012X5R1A106K
2	C2A,C2B	10µF	Ceramic Cap., 10V, X5R	SM0805	TDK	C2012X5R1A106K
0	C1C, C2C	NS				
0	C3, C4	NS				
1	R1	499k	Film Res., 5%	SM0603	Any	
1	R2	100k	Film Res.,5%	SM0603	Any	
0	R3	NS				
1	R4	40.2kΩ	Film Res., 1%	SM0603	Yageo	RC0603FR-0740k2L
1	R5	40.2kΩ	Film Res., 1%	SM0603	Yageo	RC0603FR-0740k2L
1	L1	0.47µH	Inductor, 3A	SMD	Würth	7440310047
1	U1		COT Buck	QFN2.0*1.5	MPS	MP2160GQH

EVB TEST RESULTS

Performance waveforms are tested on the evaluation board.

$V_{IN} = 5V$, $V_{OUT} = 1.2V$, $L = 0.47\mu H$, $C_{OUT} = 20\mu F$, $T_A = 25^\circ C$, unless otherwise noted.

Output Ripple
 $I_{OUT} = 1A$

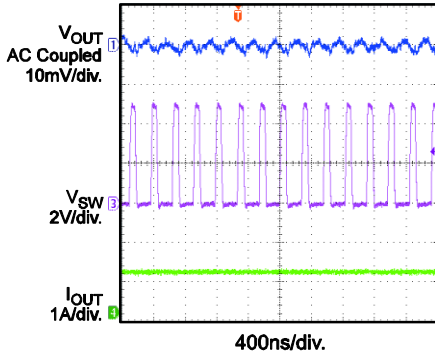

VIN Power Up without Load

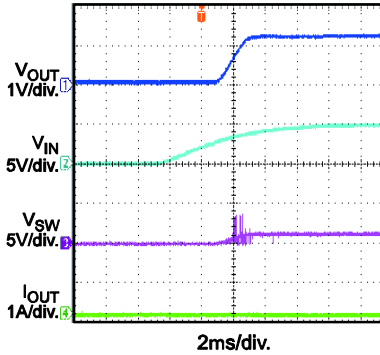

VIN Power Up with 1A Load

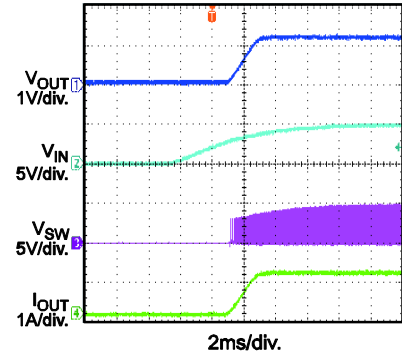

VIN Shut Down without Load

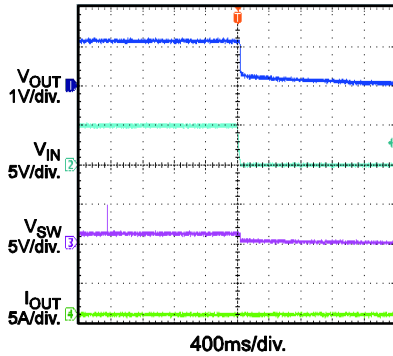

VIN Shut Down with 1A Load

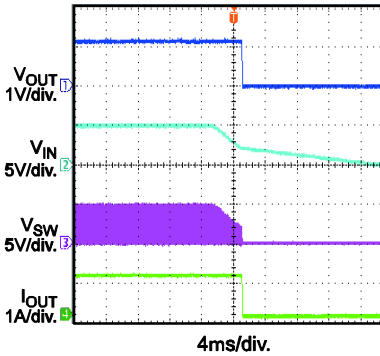

EN Start Up without Load

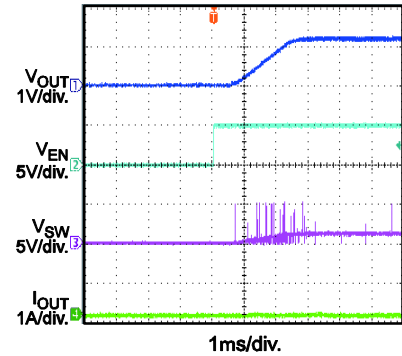

EN Start Up with 1A Load

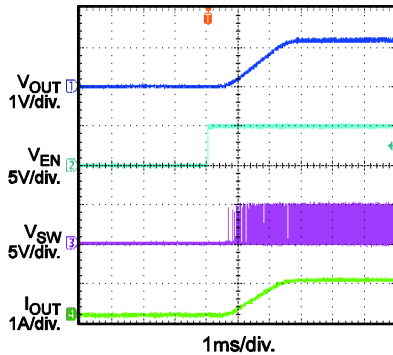

EN Shut Down without Load

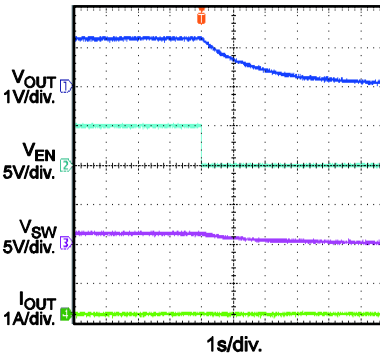

EN Shut Down with 1A Load

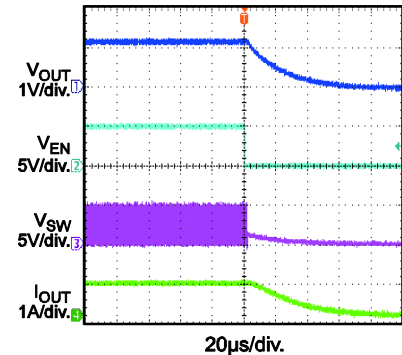

EVB TEST RESULTS

Performance waveforms are tested on the evaluation board.

$V_{IN} = 5V$, $V_{OUT} = 1.2V$, $L = 0.47\mu H$, $C_{OUT} = 20\mu F$, $T_A = 25^\circ C$, unless otherwise noted.

Power Good On without Load

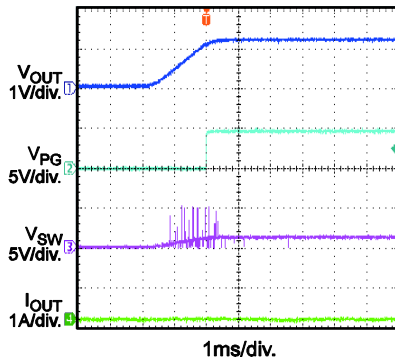

Power Good On with 1A Load

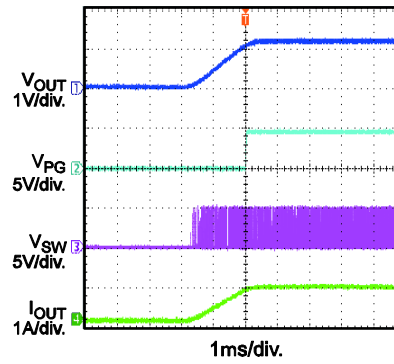

Power Good Off without Load

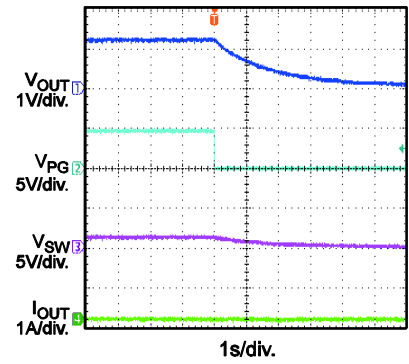

Power Good Off with 1A Load

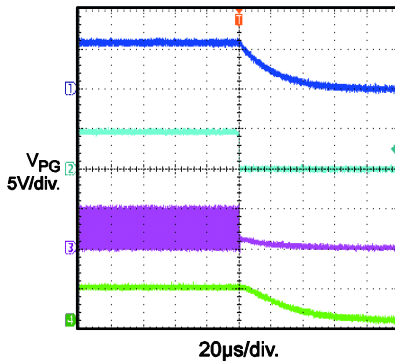

Short Circuit Entry

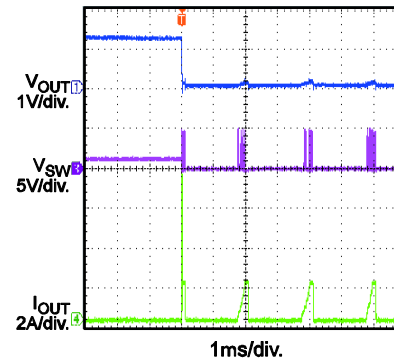

Short Circuit

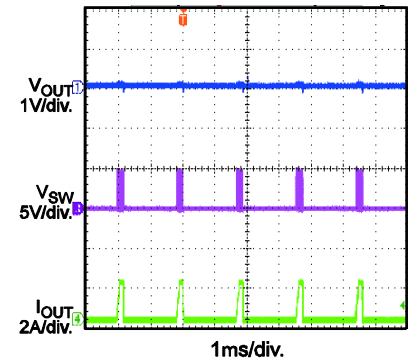

Short Circuit Recovery

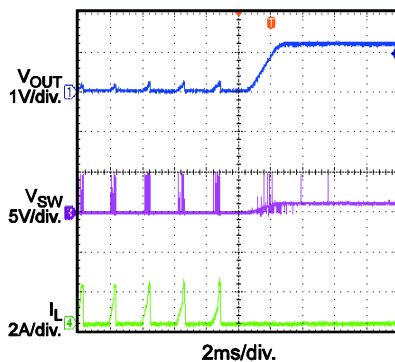

PRINTED CIRCUIT BOARD LAYOUT

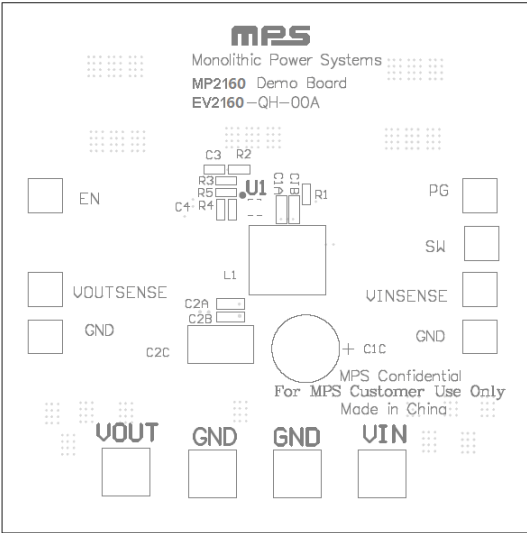

Figure 1: Top Silk Layer

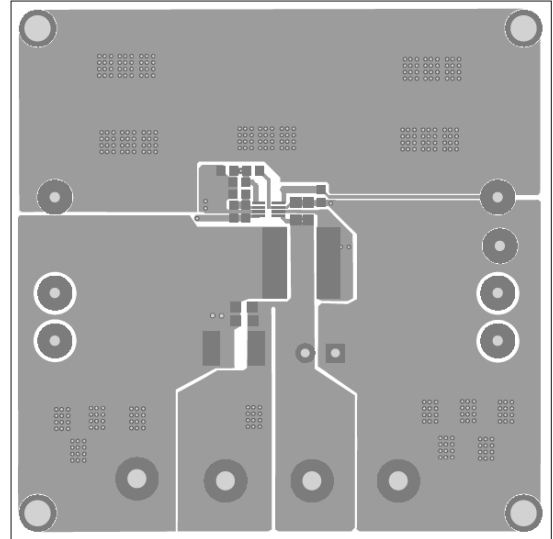

Figure 2: Top Layer

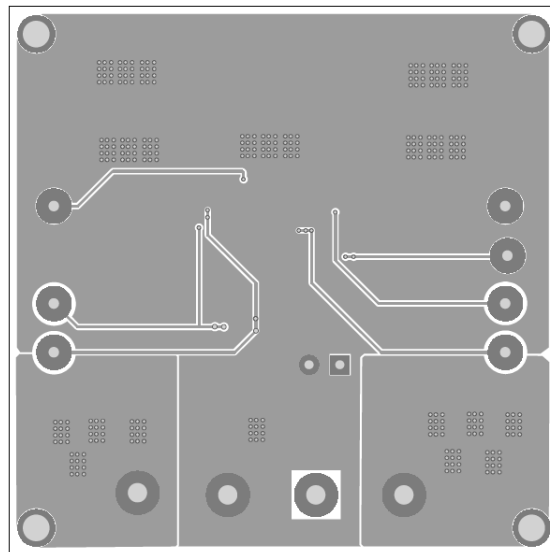

Figure 3: Bottom Layer

QUICK START GUIDE

1. Connect the positive and negative terminals of the load to the VOUT and GND pins, respectively.
2. Preset the power supply output between 2.5V and 6V, and then turn off the power supply.
3. Connect the positive and negative terminals of the power supply output to the VIN and GND pins, respectively.
4. Turn the power supply on. The board will automatically start up.
5. To use the Enable function, apply a digital input to the EN pin. Drive EN higher than 1.2V to turn on the regulator or less than 0.4V to turn it off.

LAYOUT RECOMMENDATION OF MP2160

Proper layout of the switching power supplies is very important, and sometimes critical to make it work properly. Especially, for the high switching converter, if the layout is not carefully done, the regulator could show poor line or load regulation, stability issues.

For MP2160, the high speed step-down regulator, the input capacitor should be placed as close as possible to the IC pins. As shown in Figure 4, the 0805 size ceramic capacitors (C1A and C1B) are used, please make sure the two ends of the ceramic capacitor be directly connected to PIN7 (the Power Input Pin) and PIN 5 (the Power GND Pin).

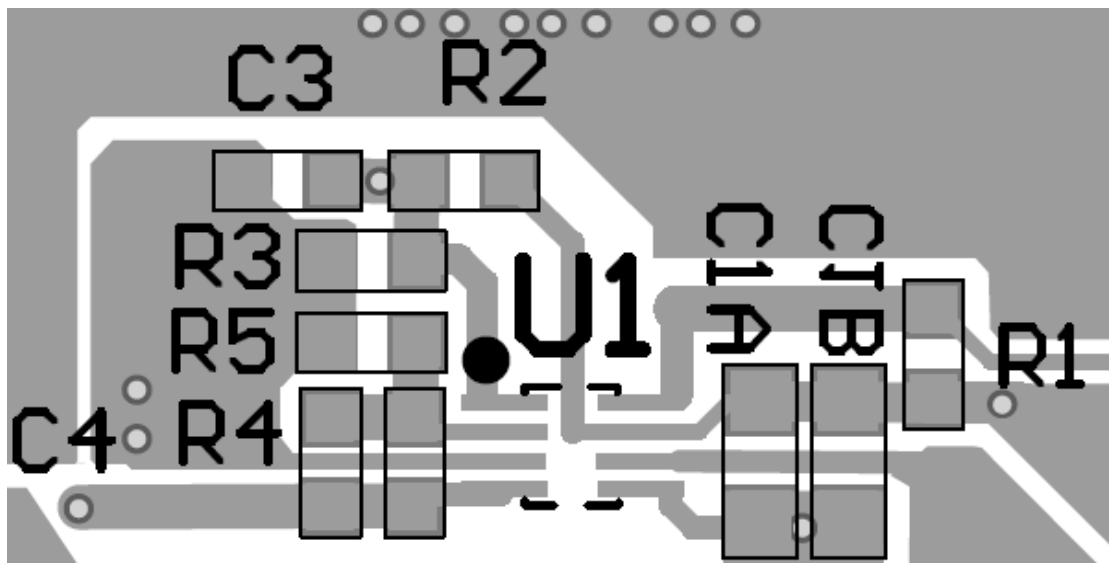

Figure 4: Two ends of Input decoupling Capacitor close to Pin 5 and Pin 7

NOTICE: The information in this document is subject to change without notice. Please contact MPS for current specifications. Users should warrant and guarantee that third party Intellectual Property rights are not infringed upon when integrating MPS products into any application. MPS will not assume any legal responsibility for any said applications.