

DESCRIPTION

The EV2013A-33-J_Q_G-00A is an evaluation board for the MP2013A-33, MPQ2013A-33 and MPQ2013A-33-AEC1, a low linear regulator that supplies power to systems with high voltage batteries.

MP2013A-33/MPQ2013A-33/MPQ2013A-33-AEC1 includes a wide 4.3V to 40V input range, low dropout voltage and low quiescent supply current. The low quiescent current and low dropout voltage allows operations at extremely low power levels. Therefore, the MP2013A-33/MPQ2013A-33/MPQ2013A-33-AEC1 is ideal for the low power microcontrollers and the battery-powered equipments.

The EV2013A-33-J_Q_G-00A is a fully assembled and tested evaluation board. It generates a +3.3V output voltage at load current up to 150mA from a 4.3V to 40V input range.

ELECTRICAL SPECIFICATIONS

Parameter	Symbol	Value	Units
Input Voltage	V_{IN}	4.3 – 40	V
Output Voltage	V_{OUT}	3.3	V
Output Current	I_{OUT}	150	mA

FEATURES

- 4.3V to 40V Input Range
- 150mA Specified Current
- 700mV Dropout at 150mA Load
- Output $\pm 2\%$ Accuracy for QFN8 Package
- Output $\pm 4\%$ Accuracy for QFN6 Package
- Specified Current Limit
- Thermal Shutdown
- -40°C to $+125^{\circ}\text{C}$ Specified Junction Temperature Range
- Includes QFN6 (2x2mm) and QFN8 (3x3mm) Packages

APPLICATIONS

- Industrial/Automotive Applications
- Portable/Battery-Powered Equipment
- Ultra low power Microcontrollers
- Cellular Handsets
- Medical Imaging

All MPS parts are lead-free, halogen free, and adhere to the RoHS directive. For MPS green status, please visit MPS website under Quality Assurance. "MPS" and "The Future of Analog IC Technology" are Registered Trademarks of Monolithic Power Systems, Inc.

EV2013A-33-J_Q_G-00A EVALUATION BOARD



(L x W x H) 2.5" x 2.5" x 0.4"
(6.35cm x 6.35cm x 1.0cm)

Board Number	MPS IC Number
EV2013A-33-J_Q_G-00A	MPQ2013AGQ/GG-33

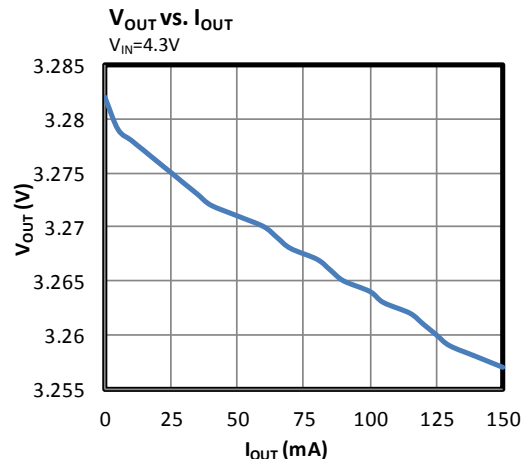

EVALUATION BOARD SCHEMATIC

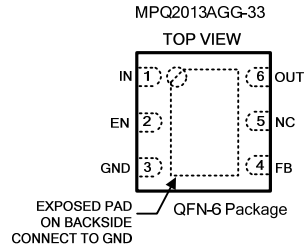
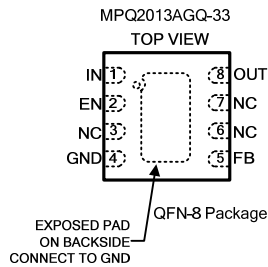
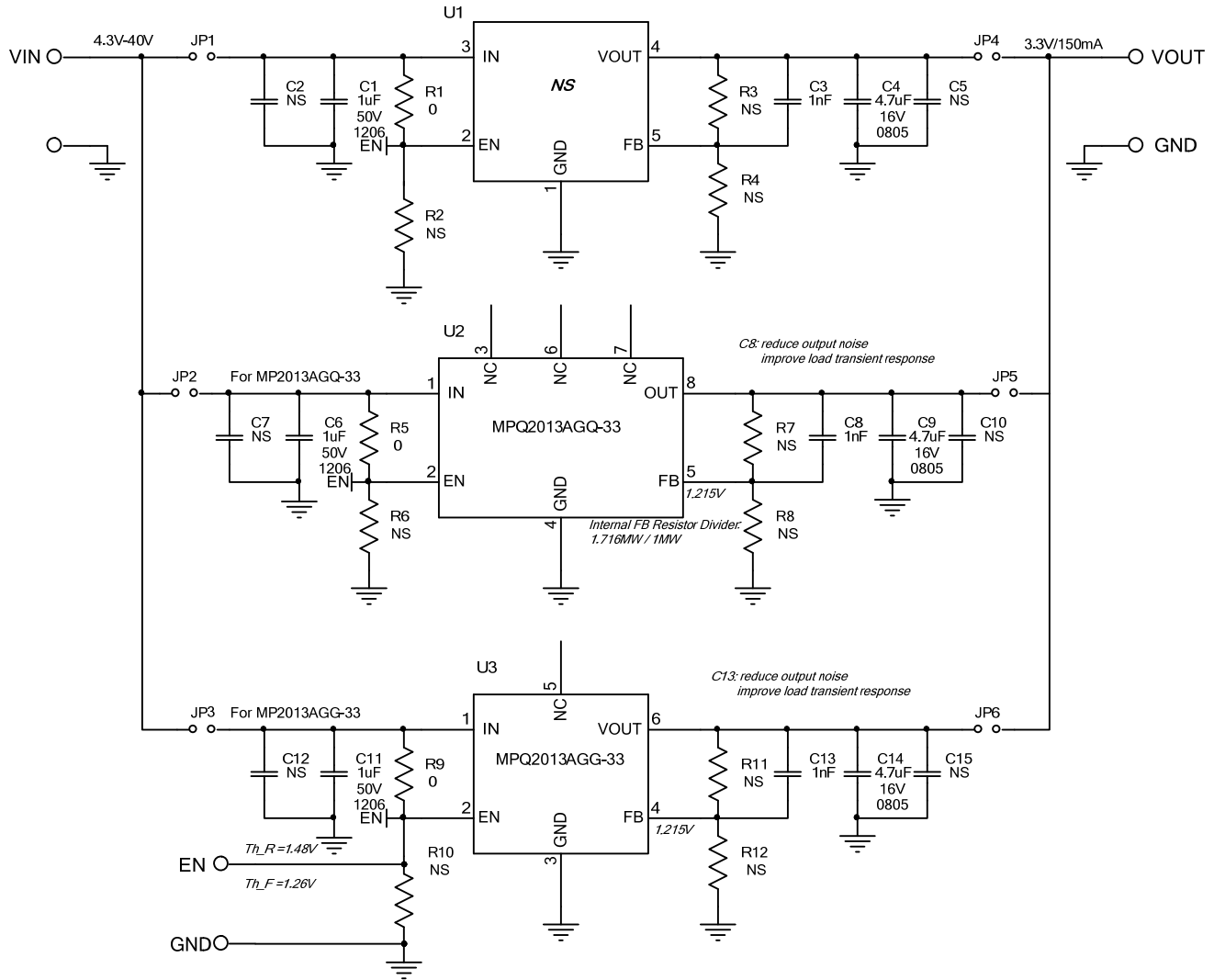

Reference for External FB Divider Selection

V _{out} (V)	R7(or R11, kΩ)	R8(or R12, kΩ)
11	84.5	10
8.5	61.9	10
8	57.6	10
6.5	44.2	10
5	31.6	10

EV2013A-33-J_Q_G-00A BILL OF MATERIALS

Qty	RefDes	Value	Description	Package	Manufacturer	Manufacturer_P/N
3	C1, C6, C11	1µF	Ceramic Cap., 50V, X7R	1206	muRata	GRM31MR71H105KA88L
3	C3, C8, C13	1nF	Ceramic Cap., 50V, X7R	0603	muRata	GRM188R71H102KA01D
3	C4, C9, C14	4.7µF	Ceramic Cap., 16V, X7R	0805	muRata	GCM21BR71C475KA73L
6	C2, C5, C7, C10, C12, C15	NS				
3	R1, R5, R9	0	Film Res., 5%	0603	Yageo	RC0603JR-070RL
9	R2, R3, R4, R6, R7, R8, R10, R11, R12	NS				
6	JP1, JP2, JP, JP4, JP5, JP6		Jumper			
1	U1	NS				
1	U2		Linear Regulator	QFN8-3x3	MPS	MPQ2013AGQ-33
1	U3		Linear Regulator	QFN6-2x2	MPS	MPQ2013AGG-33
4	VIN, GND, VOUT, GND		2.0 Golden Pin		HZ	
2	EN, GND		2.54mm Test Pin		any	

EVB TEST RESULTS

Performance waveforms are tested on the evaluation board.

$V_{OUT} = 3.3V$, $T_A = 25^\circ C$, unless otherwise noted.

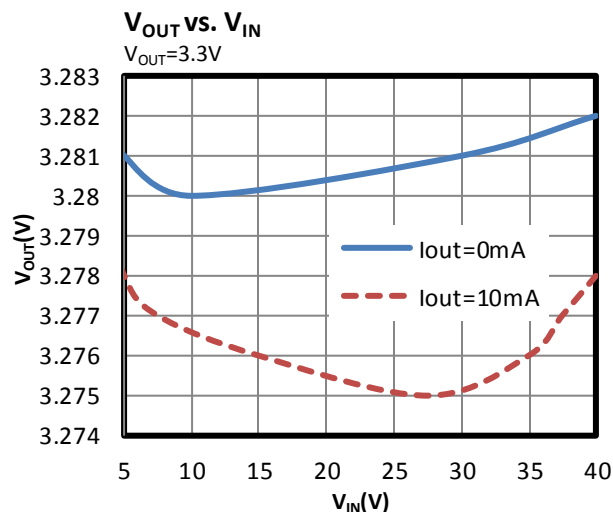
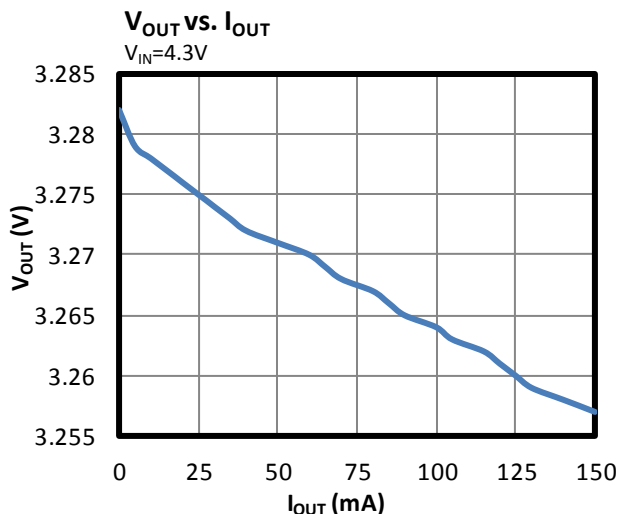

Dropout Voltage vs. Load Current

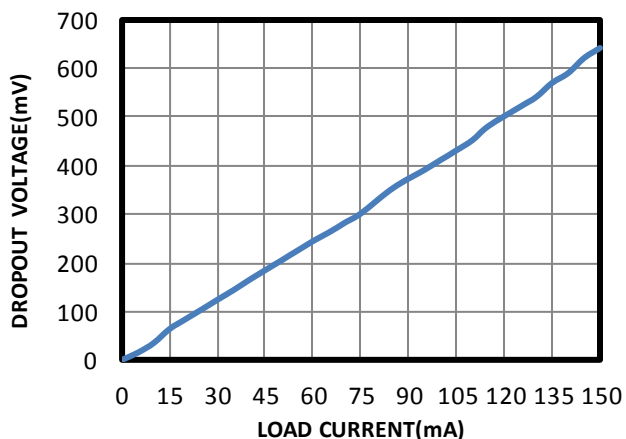

EVB TEST RESULTS *(continued)*

Performance waveforms are tested on the evaluation board.

$V_{OUT} = 3.3V$, $T_A = 25^\circ C$, unless otherwise noted.

Load Transient

$V_{IN}=12V$, $I_{OUT}=8mA-150mA$

CH1: V_{OUT}/AC
200mV/div.
CH4: I_{OUT}
50mA/div.

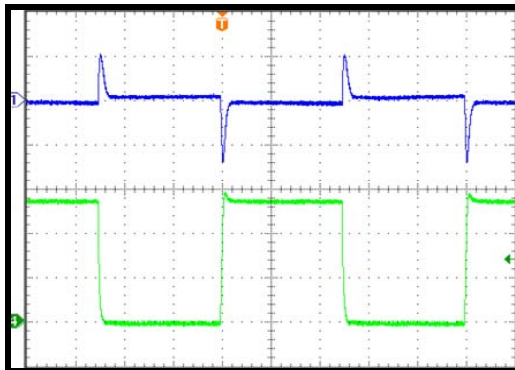

1ms/div.

Startup through V_{IN}

$V_{IN}=12V$, $I_{OUT}=150mA$

CH3: V_{IN}
5V/div.
CH4: I_{OUT}
50mA/div.
CH1: V_{OUT}
2V/div.

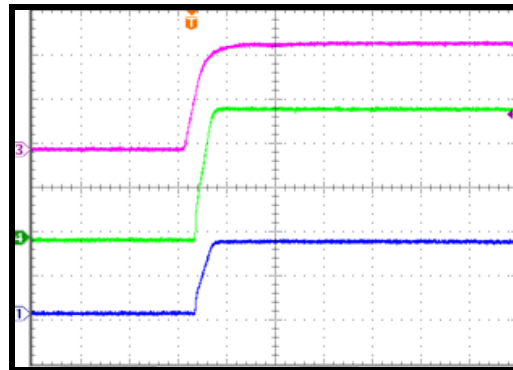

4μs/div.

Line Transient

$V_{IN}=4.3V-5.3V$, $I_{OUT}=150mA$

CH1: V_{OUT}/AC
50mV/div.
CH3: V_{IN}
1V/div.

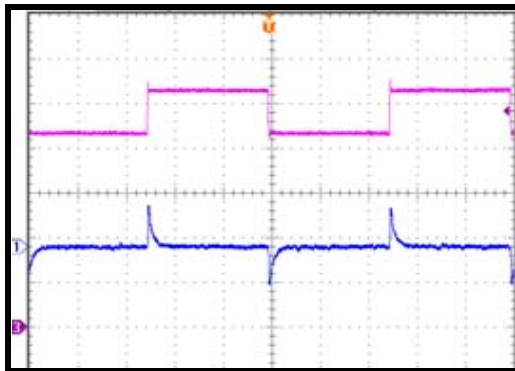

20ms/div.

Shutdown through V_{IN}

$V_{IN}=12V$, $I_{OUT}=150mA$

CH3: V_{IN}
5V/div.
CH4: I_{OUT}
50mA/div.
CH1: V_{OUT}
2V/div.

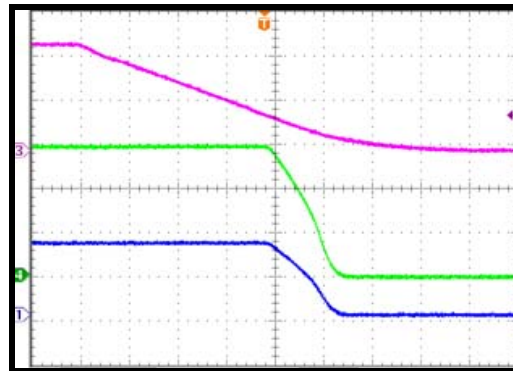

20ms/div.

Short Circuit Entry

$V_{IN}=12V$, $I_{OUT}=0mA$ to short circuit

CH4: I_{OUT}
500mA/div.
CH1: V_{OUT}
2V/div.

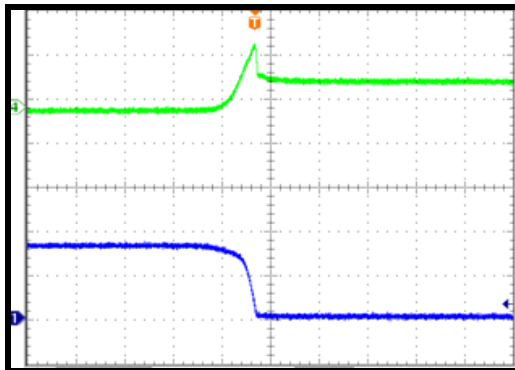

100ms/div.

Short Circuit Recovery

$V_{IN}=12V$, short circuit to $I_{OUT}=0mA$

CH4: I_{OUT}
200mA/div.
CH1: V_{OUT}
2V/div.

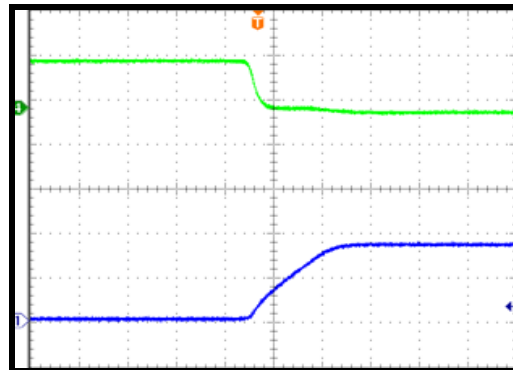

20ms/div.

EVB TEST RESULTS *(continued)*

Performance waveforms are tested on the evaluation board.

$V_{OUT} = 3.3V$, $T_A = 25^\circ C$, unless otherwise noted.

Short Circuit Steady State

$V_{IN} = 12V$

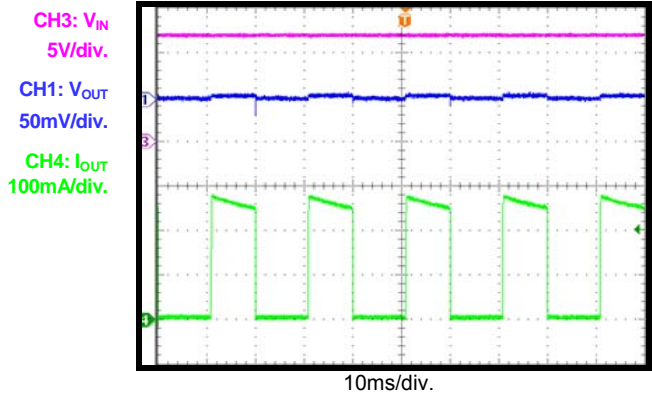

QUICK START GUIDE

1. Connect different jumpers to select different MPQ2013A-33 ICs with different packages for evaluation:

Connected Jumpers	Selected IC
JP2, JP5	MPQ2013AGQ-33
JP3, JP6	MPQ2013AGG-33

2. Connect the positive and negative terminals of the load to the V_{OUT} and GND pins, respectively. Set load current between 0-150mA. Be aware that electronic loads represent a negative impedance to the regulator and if set to a too high current will trigger over-current-protection or short-current-protection.

Note that both MPQ2013AGQ-33 and MPQ2013AGG-33 will start up with no load when either JP2 or JP3 is connected. JP5 or JP6 is connected determines MPQ2013AGQ-33 or MPQ2013AGG-33 to support load current. MPQ2013AGQ-33(MPQ2013AGG-33) starts up solely when remove R1, R9(R5) and connect JP2(JP3).

3. Preset the power supply output between 4.3V and 40V, and then turn it off. (If longer cables are used between the source and the EVB (>0.5m total), a damping capacitor should be installed at the input terminals. Especially when $V_{IN} \geq 24V$.)
4. Connect the positive and negative terminals of the power supply output to the V_{IN} and GND pins, respectively.
5. Turn the power supply on. The MPQ2013A-33 will automatically startup. The default V_{OUT} is 3.3V.
6. To use EN turning on/off MPQ2013A-33, remove R5 or R9 first. Then give a voltage between EN and GND higher than 1.48V to turn on, lower than 1.26V to turn off.
7. Setting V_{OUT}

MPQ2013A-33 default V_{OUT} is 3.3V, which internal FB resistor divider is $1.716M\Omega/1M\Omega$. Also, it can set V_{OUT} of the MPQ2013A-33 by using an external resistor divider, R7/R8 for MPQ2013AGQ-33.

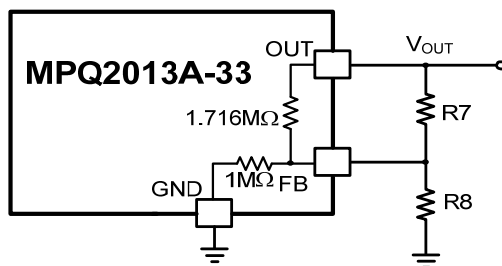

To lower the additional current dissipation, resistors of FB divider on the demo board are chosen to high value. If part would performance no load when $T_a > 85^\circ C$, FB dividers should be lower to maintain a minimum load to draw the leakage current from OUT pin. The recommended maxim value of R8 is $1M\Omega$ when $T_a \leq 105^\circ C$ and $210K\Omega$ when $T_a \leq 125^\circ C$. Once R8 is determined, R7 can be calculated by below formula:

$$R7 = \frac{1.716M\Omega}{\frac{1.215 \times 1.716M\Omega \times (R8 + 1M\Omega)}{(V_{OUT} - 1.215) \times R8 \times 1M\Omega} - 1}$$

Setting V_{IN} UVLO

To prevent part from operating at an insufficient power supply voltage, a resistor divider can be used to adjust the V_{IN} UVLO point, R5/R6 for MPQ2013AGQ-33.

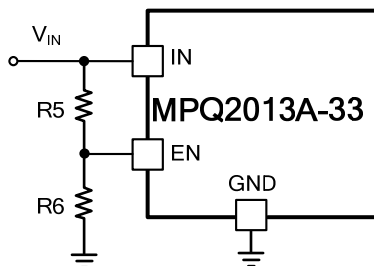

If choose R5 first, then R6 can be calculated by below equation:

$$R6 = R5 / (V_{IN_UVLO_F} / EN_{TH_F} - 1)$$

Where $V_{IN_UVLO_F}$ is desired V_{IN} UVLO falling threshold, EN_{TH_F} is the EN falling threshold 1.26V. To limit the divider current, high value resistors are recommended. For example, if $V_{IN_UVLO_F}$ is set at 4.5V, R5=2MΩ and R6=778kΩ can be used.

NOTICE: The information in this document is subject to change without notice. Please contact MPS for current specifications. Users should warrant and guarantee that third party Intellectual Property rights are not infringed upon when integrating MPS products into any application. MPS will not assume any legal responsibility for any said applications.