



The Future of Analog IC Technology®

# EV1906-S-00A

## 80V, High Frequency Half-Bridge Gate Driver EV Board

### DESCRIPTION

This is EV board documentation for MP1906. The MP1906 is a high-performance, 80V, gate driver that can drive two external N-MOSFETs in a half-bridge configuration with 12V gate supply. It accepts independent gate input signals and provides shoot-through prevention. During voltage lockout, the output of the high- and low-side driver goes low to prevent erratic operation under low supply conditions. The high-current driving capability and short dead time make it suitable for high-power and high-efficiency power applications.

This demo board is configured to a Half-Bridge.. For simplicity, HPWM and LPWM are connected together and drove by a same PWM signal generated by NE555. The user can evaluate MP1906 performance expediently..

### ELECTRICAL SPECIFICATION

Parameter	Symbol	Value	Units
Driver Voltage	V <sub>DD</sub>	10 – 16	V
Input Power Voltage	V <sub>POWER</sub>	0-80	V
Duty	D	50	%
Frequency	F <sub>SW</sub>	200	kHz

### FEATURES

- Drives Two Low Cost and High-Efficiency N-MOSFETs
- 10V-16V Gate Drive Supply
- 3.3V, 5V Logic Compatibility
- 80ns Propagation Delay Time
- Less than 90µA Quiescent Current
- Undervoltage Lockout for Both Channels
- Input Signal Overlap Protection
- Internal 150ns Dead Time
- Available in a Compact 8-pin SOIC Package

### APPLICATIONS

- Motor Drivers
- Half-Bridge Power Supplies
- Avionics DC-DC converters
- Active-clamp Forward Converters

All MPS parts are lead-free and adhere to the RoHS directive. For MPS green status, please visit MPS website under Products, Quality Assurance page.

"MPS" and "The Future of Analog IC Technology" are registered trademarks of Monolithic Power Systems, Inc.

### EV1906-S-00A EVALUATION BOARD



(L x W x H) 6.4cm x 6.4cm x 2.5cm

Board Number	MPS IC Number
EV1906-S-00A	MP1906DS

### EVALUATION BOARD SCHEMATIC

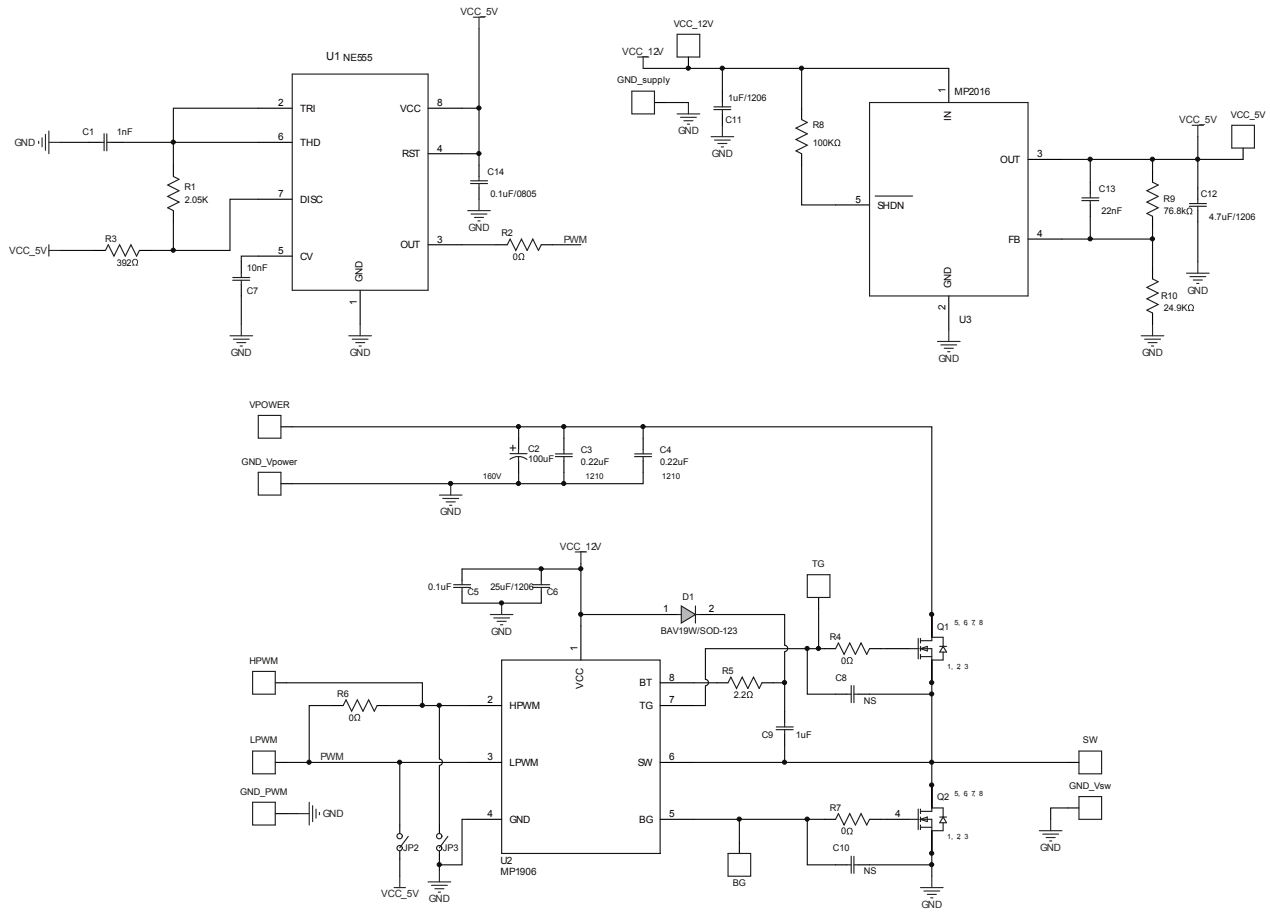

**EV1906-S-00A BILL OF MATERIALS**

Qty	RefDes	Value	Description	Package	Manufacturer	Manufacturer P/N
1	C1	1nF	Ceramic Cap,16V,X7R	0603	muRata	GRM188R71C102KA01D
1	C2	100µF	100V, Aluminium Cap	10X22X5 mm	红宝石	CD11-100V-100µF
2	C3,C4	0.22µF	Ceramic Cap., 250V, X7R	1210	muRata	GRM32DR72E224KW01D
2	C5,C14	0.1µF	Ceramic Cap., 16V, X7R	0805	muRata	GRM219R71C104KA01D
1	C6	22µF	Ceramic Cap,25V,X7R	1206	muRata	GRM31ER71E226KE15L
1	C7	10nF	Ceramic Cap,16V,X7R	0603	muRata	GRM188R71C103KA01D
2	C8,C10	NS		0603		
1	C9	1µF	Ceramic Cap, 25V, X5R	0805	muRata	GRM216R61E105KA12D
1	C11	1µF	Ceramic Cap, 25V, X7R	1206	muRata	GRM31MR71E105KC01L
1	C12	4.7µF	Ceramic Cap, 25V, X7R	1206	muRata	GRM31CR71E475KA88L
1	C13	22nF	Ceramic Cap,16V,X7R	0603	muRata	GRM188R71C223KA01D
1	R1	2.05k	Thick Film Res, 1%	0603	ROYAL	RL0603FR-072K05L
2	R3	392Ω	Thick Film Res, 1%	0603	ROYAL	RL0603FR-07392RL
4	R2,R4, R6,R7	0Ω	Thick Film Res., 1%	0603	Yageo	RC0603FR-070RL
1	R5	2.2Ω	Thick Film Res., 1%	0603	ROYAL	RL0603FR-072R2L
1	R8	100k	Thick Film Res., 1%	0603	ROYAL	RL0603FR-07100KL
1	R9	76.8k	Thick Film Res., 1%	0603	ROYAL	RC0603FR-0776K8L
1	R10	24.9k	Thick Film Res., 1%	0603	ROYAL	RL0603FR-0724K9L
1	D1	BAV19W	Switching diodes	SOD-123	DIODES	BAV19W-7-F
2	Q1,Q2	Si4100DY	N-channel MOSFET	SO8	VISHAY	Si4100DY
1	U1	NE555	General Purpose Single Bipolar Timers	SOIC8	STMicroelectronics	NE555D
1	U2	MP1906	80V Half Bridge Driver	SOIC8	MPS	MP1906R2
1	U3	MP2016	LDO, 5V, 30mA	TSOT23-5	MPS	MP2016D

### EVB TEST RESULTS

Performance waveforms are tested on the evaluation board.

$V_{POWER} = 80V$ ,  $V_{DD} = 12V$ , Duty=50%, Frequency=200kHz,  $T_A = 25^{\circ}C$ , unless otherwise noted.

#### HPWM to TG Delay with MOSFET

$V_{POWER}$  is not applied

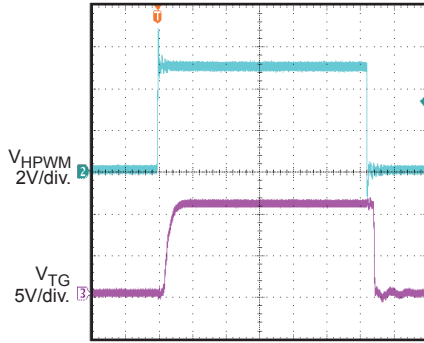

400ns/div.

#### LPWM to BG Delay with MOSFET

$V_{POWER}$  is not applied

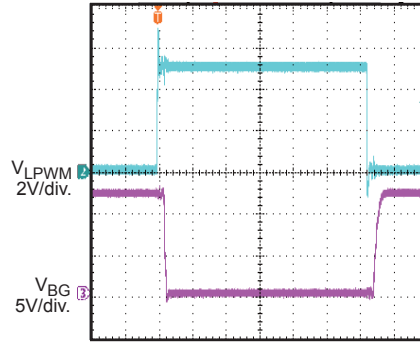

400ns/div.

#### Generated TG and BG from SW

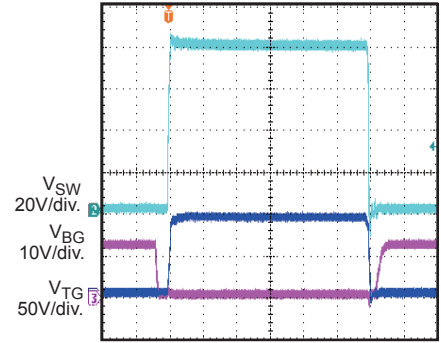

400ns/div.

**PRINTED CIRCUIT BOARD LAYOUT**

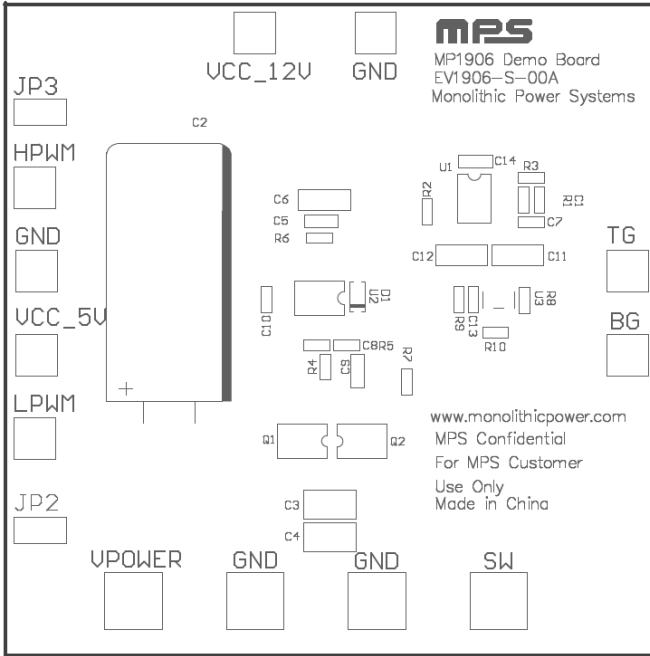

**Figure 1—Top Silk Layer**

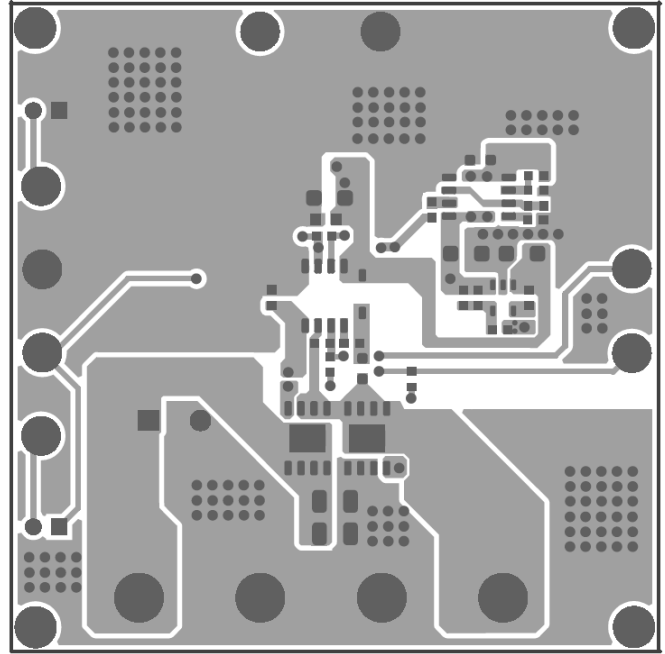

**Figure 2—Top Layer**

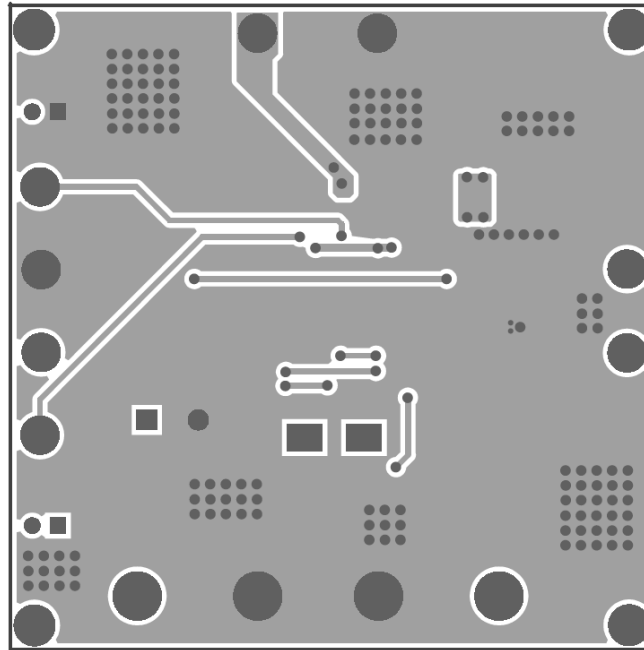

**Figure 3—Bottom Layer**

## QUICK START GUIDE

EV1906-S-00A is configured in a half-bridge. Below is the recommended setting for users to evaluate the EV board.

1. Preset Driver Power Supply between 10V-16V.
2. Preset Input Power Supply between 0V-80V.
3. Connect Driver Power Supply terminals to:
  - a. Positive (+): VCC\_12V
  - b. Negative (-): GND
4. Connect Input Power Supply terminals to:
  - a. Positive (+): VPOWER
  - b. Negative (-): GND
5. Connect Load to:
  - a. Positive (+): SW
  - b. Negative (-): GND
6. Turn on Driver Power Supply.
7. To turn off the board, please follow these steps:
  - a. Turn off load.
  - b. Turn off Input Power Supply.
  - c. Turn off Driver Power Supply.

**NOTICE:** The information in this document is subject to change without notice. Please contact MPS for current specifications. Users should warrant and guarantee that third party Intellectual Property rights are not infringed upon when integrating MPS products into any application. MPS will not assume any legal responsibility for any said applications.