



The Future of Analog IC Technology®

MP2608

28V, 1A Dual Input Linear Battery Charger With Timer

DESCRIPTION

The MP2608 is a dual-input, linear, high-performance low-cost single cell Li-Ion or Li-Polymer battery charger. It accepts two power inputs, one from a USB (Universal BUS) port and the other from an AC adapter. By integrating high voltage input protection into the charger IC, the MP2608 can tolerate an input surge up to 28V. Due to the protection inputs function, low-cost, large output tolerance adapters can be used safely.

The device features constant current (CC) and constant voltage (CV) charging modes with programmable charge currents (100mA to 1.0A), current blocking and trickle charge. The charge current for adapter input can be programmed by an external resistor, while the charge current for USB input is pre-set at 450mA. The device also provides charge status and fault indications to the system.

For guaranteed safe operation, the MP2608 folds back charge current when the device is heated up due to limited PCB space. Other safety features are including battery temperature monitoring, and programmable timer to complete the charging cycle.

MP2608 is available in a 10-pin 3mm x 3mm QFN package.

FEATURES

- Complete Solution for Charging Single-Cell Lion-Ion Battery
- Input Surge Up to 28V
- Adapter and USB Input
- Programmable Charge Current: 100mA to 1.0A
- Pre-set USB Charge Current: 450mA
- Proprietary Constant Voltage Auto Recharge
- Proprietary Over-Voltage Protection
- 0.75% V_{BATT} Accuracy over Temperature
- $<1\mu A$ Battery Reverse Current
- 125 μA Standby Current from V_{IN}
- Battery Temperature Monitoring
- Thermal Protection
- Fault and Charge Status Indicators
- Internal Soft-Start
- Tiny 3mm x 3mm QFN Package

APPLICATIONS

- Cell Phones
- Digital Cameras
- Smart Phones
- PDAs
- MP3 Players

"MPS" and "The Future of Analog IC Technology" are Registered Trademarks of Monolithic Power Systems, Inc.

TYPICAL APPLICATION

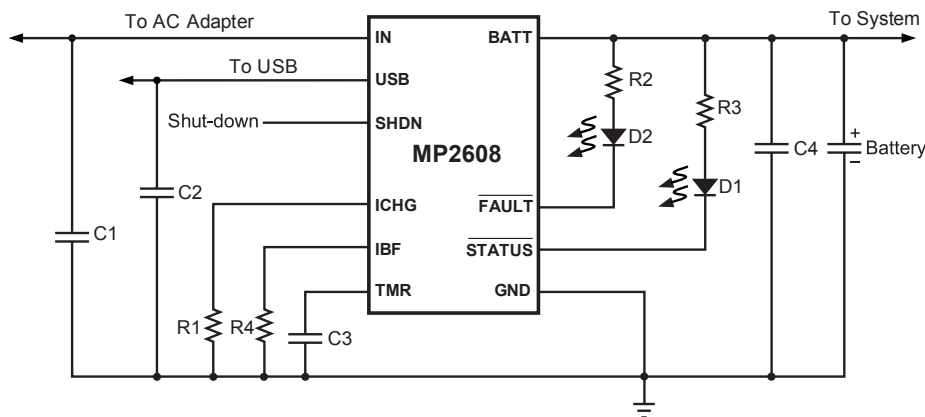

PACKAGE REFERENCE

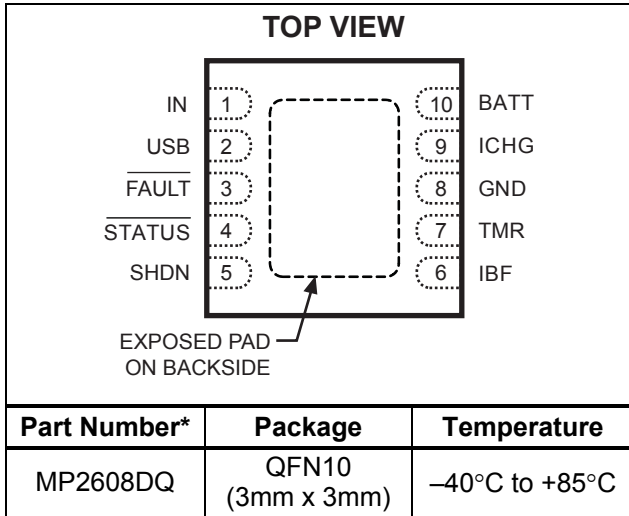

* For Tape & Reel, add suffix -Z (eg. MP2608DQ-Z)
 For RoHS compliant packaging, add suffix -LF
 (eg. MP2608DQ-LF-Z)

ABSOLUTE MAXIMUM RATINGS ⁽¹⁾

IN, USB to GND -0.3V to +28V
 All Other Pins to GND -0.3V to +6.5V
 Junction Temperature 140°C
 Lead Temperature 260°C
 Storage Temperature -65°C to +150°C

Recommended Operating Conditions ⁽²⁾

Nominal Supply Voltage V_{IN} 3.5V to 5.5V
 Operating Temperature -40°C to +85°C

Thermal Resistance ⁽³⁾ θ_{JA} θ_{JC}
 3x3 QFN10 50 12... °C/W

Notes:

- 1) Exceeding these ratings may damage the device.
- 2) The device is not guaranteed to function outside of its operating conditions.
- 3) Measured on approximately 1" square of 1 oz copper.

ELECTRICAL CHARACTERISTICS

$V_{IN} = 5V$, $V_{EN} = 0V$, $T_A = +25^\circ C$, unless otherwise noted.

| Parameter | Symbol | Condition | Min | Typ | Max | Units |
|---------------------------------------|-------------------|---|-------|-------|-------|----------------------------|
| IN, USB Input Voltage | V_{IN}, V_{USB} | | 4.5 | | 28 | V |
| IN, USB Input Under-voltage Threshold | V_{IN-UV} | IN Input Rising | 3.75 | 4 | 4.25 | V |
| IN, USB Input Over-voltage Threshold | V_{IN-OV} | IN Input Rising | 5.8 | 6.0 | 6.2 | V |
| Supply Current | I_{SUPPLY} | SHDN= Low and BATT floating | | | 100 | μA |
| | | SHDN = High and BATT floating | | | 80 | |
| Charger | | | | | | |
| Battery Voltage Regulation | V_{BATT} | $T = +25^\circ C, I_{BATT} = 0$ | 4.179 | 4.200 | 4.221 | V |
| | | $T = 0^\circ C \text{ to } +50^\circ C, I_{BATT} = 0$ | 4.168 | 4.200 | 4.232 | |
| | | $T = -5^\circ C \text{ to } +75^\circ C, I_{BATT} = 0$ | 4.158 | 4.200 | 4.242 | |
| Battery Over-Voltage Protection | I_{BATT_OVP} | $V_{BATT} = 4.25V$ | | | 0 | μA |
| Constant Current Regulation | $I_{CHG,IN}$ | $V_{IN} = 5V, V_{BATT} = 3.8V$ $R_{CHG} = 2.3k\Omega$ | 640 | 708 | 780 | mA |
| | $I_{CHG,USB}$ | $V_{IN}=0V, V_{USB} = 5V, V_{BATT}=3.8V$ | 410 | 450 | 490 | mA |
| Constant Current Variation | | $V_{IN} = 5V, V_{BATT} = 3.8V,$ $T_J = 0^\circ C \text{ to } +120^\circ C,$ $R_{CHG} = 1.6k\Omega \text{ to } 8.0k\Omega$ | 87 | 100 | 113 | % I_{CHG} ⁽⁴⁾ |

ELECTRICAL CHARACTERISTICS *(continued)*
 $V_{IN} = 5V$, $V_{EN} = 0V$, $T_A = +25^{\circ}C$, unless otherwise noted.

| Parameter | Symbol | Condition | Min | Typ | Max | Units |
|--|---------------|--|-----|----------|-----|-------------------|
| Pass Device Drop-out Voltage | $V_{DRO,IN}$ | $V_{IN} = 4V$, $R_{CHG} = 1.5k\Omega$, 1A load on the BATT pin | | 130 | | mV |
| | $V_{DRO,USB}$ | $V_{USB} = 4V$, 400mA load on the BATT pin | | 152 | | mV |
| Trickle Current | | $V_{IN} = 5V$, $V_{BATT} = 2.3V$ | 5 | 10 | 15 | $\%I_{CHG}^{(4)}$ |
| IBF Accuracy | | | -20 | | +20 | %IBF |
| Trickle Threshold Voltage | | | 2.5 | 2.6 | 2.7 | V |
| Trickle Voltage Hysteresis | | | | 100 | | mV |
| SHDN Trip High Threshold | | | 2.0 | | | V |
| SHDN Trip Low Threshold | | | | | 0.4 | V |
| SHDN Pull-down Resistor | | | | 500 | | k Ω |
| \overline{FAULT} , STATUS Sink Current | | Pin Voltage = 0.4V | 4 | | | mA |
| Battery Reverse Current to BATT Pin | | SHDN = High and Input = Floating or 0V | | | 1 | μA |
| Thermal Shutdown Threshold | | | 105 | 120 | 135 | $^{\circ}C$ |
| Thermal Shutdown Hysteresis | | | | 10 | | $^{\circ}C$ |
| Recharge Threshold | | | | | | |
| Recharge Voltage Threshold | V_{RECHG} | | | 4.0 | | V |
| Oscillator | | | | | | |
| Oscillator Period | T_{OSC} | $C_{TIME} = 15nF$ | 4.8 | 6.0 | 7.2 | ms |
| TIMEOUT Period | $T_{TIMEOUT}$ | | | 2^{15} | | T_{OSC} |

Notes:

 4) I_{CHG} is the target preprogrammed charge current (Die temperature below 110 $^{\circ}C$).

PIN FUNCTIONS

| Pin # | Name | Description |
|-------|----------------------------|---|
| 1 | IN | Input Supply. IN receives the AC adapter supply voltage. |
| 2 | USB | Input Supply. USB receives the USB supply voltage. |
| 3 | $\overline{\text{FAULT}}$ | Open-Drain Fault Status Indicator. This pin is low under any fault conditions. |
| 4 | $\overline{\text{STATUS}}$ | Open-Drain Charge Indicator. This pin is low during charging. |
| 5 | SHDN | Charger IC Shut-down. Pull SHDN high to disable the IC or leave it floating to enable the IC. |
| 6 | IBF | Programmable Input for end of charger current. |
| 7 | TMR | Oscillator Period Timer. Connect a timing capacitor between this pin and GND to set the oscillator period. A 1uF capacitor on the TMR pin will make the oscillator period 400ms. |
| 8 | GND | Ground. Exposed pad and GND must connect to same ground plane. |
| 9 | ICHG | Constant Charge Current Program for the IN input. Connect this pin to an external resistor to program the charging current in CC Mode when the current from the IN pin charges the battery. |
| 10 | BATT | Charger Output. |

TYPICAL PERFORMANCE CHARACTERISTICS

$V_{IN}=5V$, $C_{IN}=2.2\mu F$, $C_{OUT}=1\mu F$, $R_{CHG}=2.21k\Omega$, $T_A=25^\circ C$, unless otherwise noted.

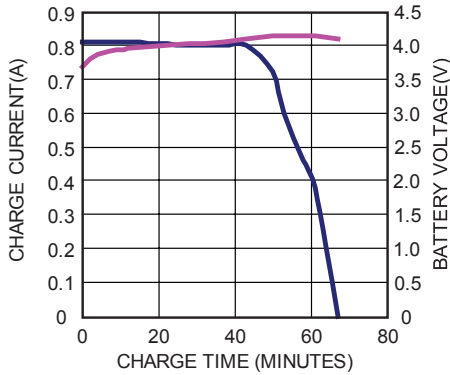
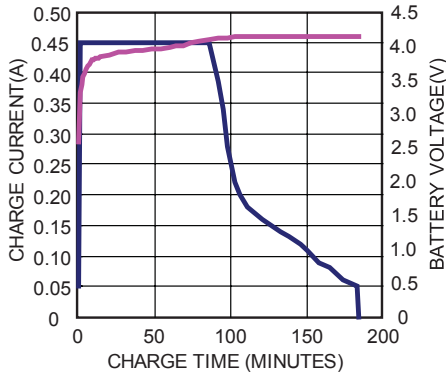
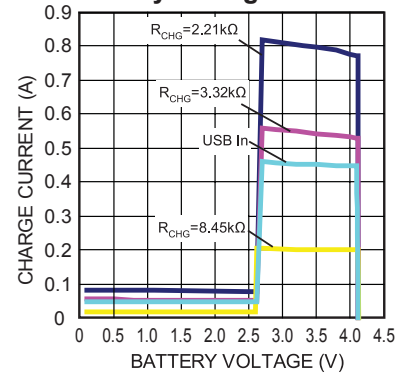
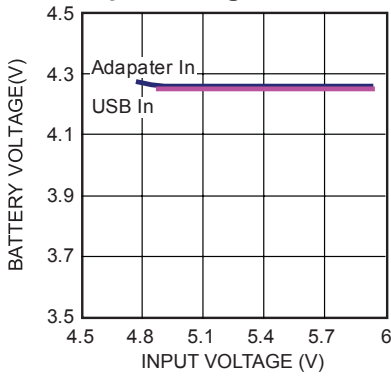
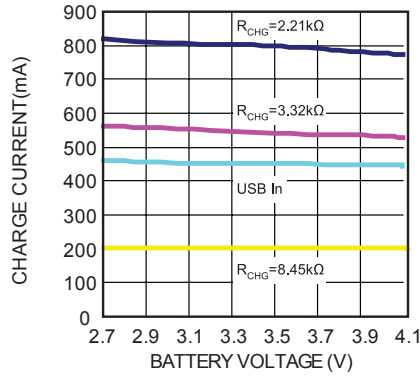
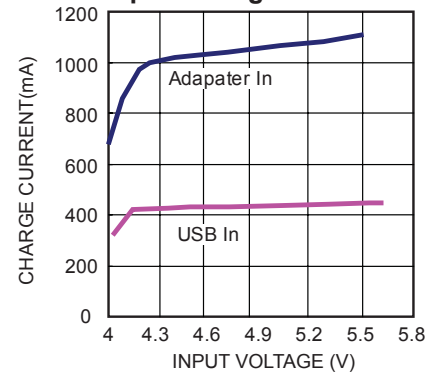
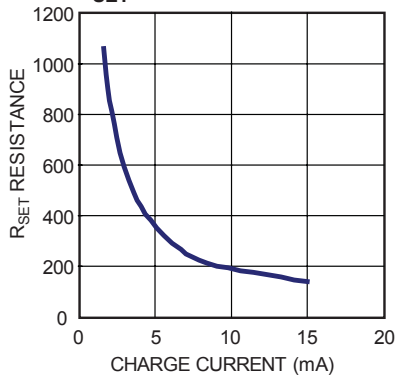
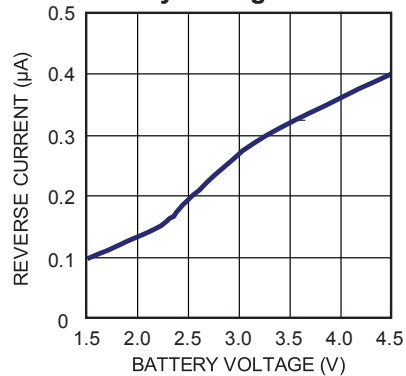
Battery Charge Curve

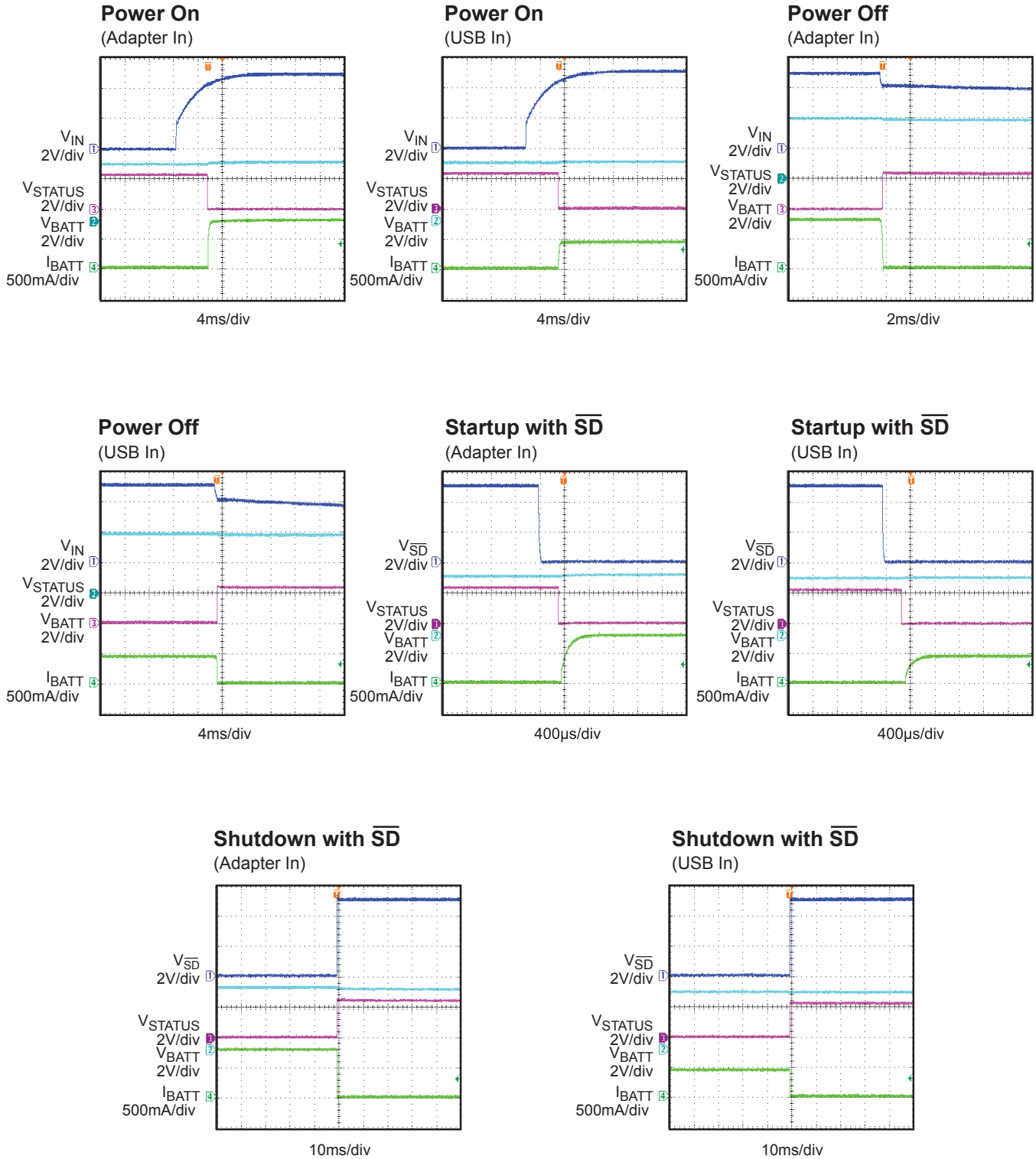
Battery Charge Curve

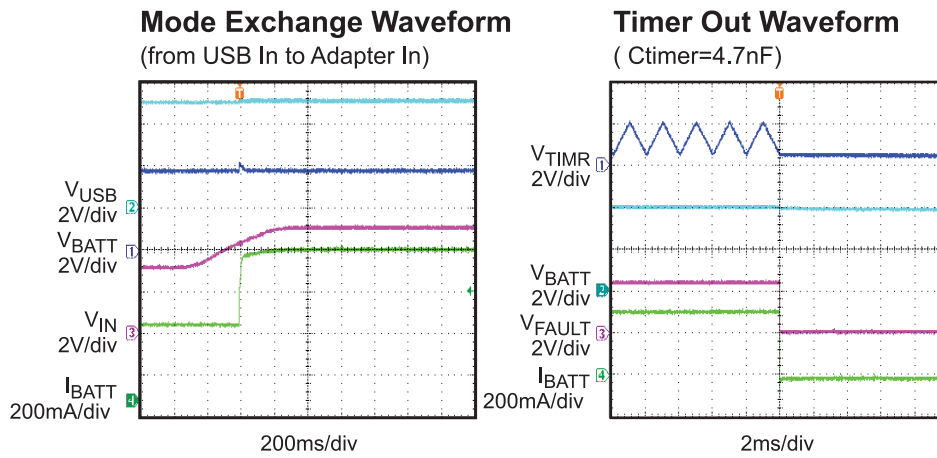
Charge Current vs. Battery Voltage

Battery Voltage vs. Input Voltage

Charge Current vs. Battery Voltage

Charge Current vs. Input Voltage

Charge Current vs. R_{SET} Resistance

Reverse Current vs. Battery Voltage

TYPICAL PERFORMANCE CHARACTERISTICS (continued)
 $V_{IN}=5V$, $C_{IN}=2.2\mu F$, $C_{OUT}=1\mu F$, $R_{CHG}=2.21k\Omega$, $T_A=25^\circ C$, unless otherwise noted.

TYPICAL PERFORMANCE CHARACTERISTICS (continued)
 $V_{IN}=5V$, $C_{IN}=2.2\mu F$, $C_{OUT}=1\mu F$, $R_{CHG}=2.21k\Omega$, $T_A=25^\circ C$, unless otherwise noted.

BLOCK DIAGRAM

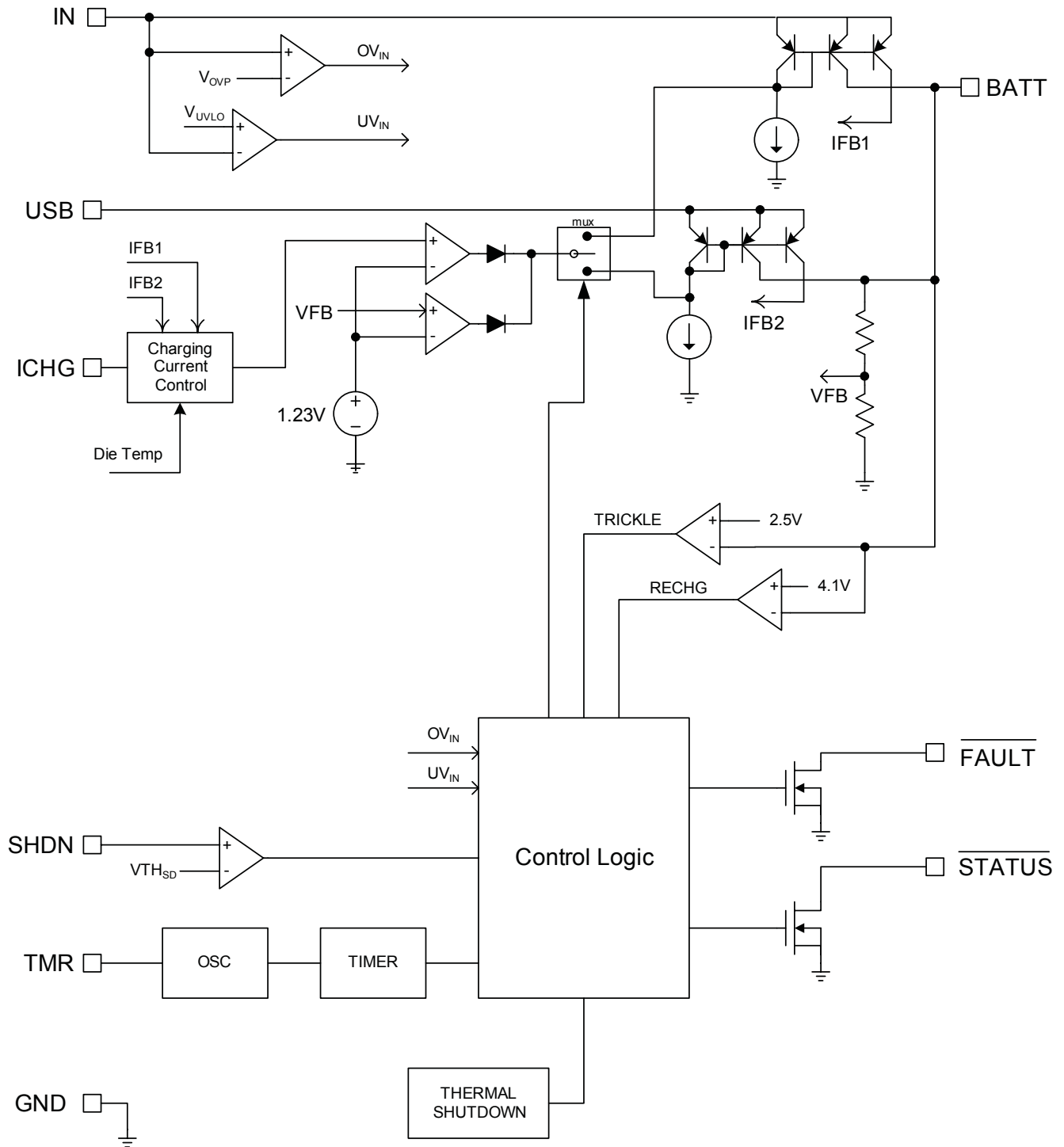

Figure 1—Functional Block Diagram

OPERATION

Input Auto Selection and Voltage Range

The MP2608 is a dual-input charger, when both input sources are present, MP2608 selects only one power source to charge the battery. When the adapter input voltage is higher than the UVLO threshold, IN is selected as the power source. Otherwise the USB input is selected. If both the inputs is above UVLO but the adaptor input voltage is below the battery voltage, while the USB voltage is higher than the battery voltage, then the USB input is used to charge the battery.

In case there is no power source available or both the two input are below the UVLO, the MP2608 is in the sleep mode, in which the current into the BATT pin is reduced to TBD μ A. The IC is also disabled to prevent the battery from draining.

The MP2608 has built-in input voltage surge protection as high as +28V. The charger IC will be automatically disabled when the input voltage is lower than 2.5V or higher than 6.0V.

Charge Cycle (Mode Change: Trickle -> CC-> CV)

Figure 2 below shows the typical charging profile for the MP2608. For a fully depleted battery with a terminal voltage lower than 2.6V, the MP2608 will start with the trickle charge (preconditioning) at 10% of the programmed full charge current. After the battery voltage reaches 2.6V, the charger begins charging at the constant current of the programmed value (I_{CHG}) and the charge timer starts counting down. This is referred to as Constant Current (CC) mode. Once the battery voltage reaches 4.2V, the charger will operate in the constant voltage (CV) mode until the battery is fully charged. The charge current drops during CV mode, and the battery full indication is set when the charge timer is time off. The charge timer is to protect the system from charging a dead battery for excessive long time.

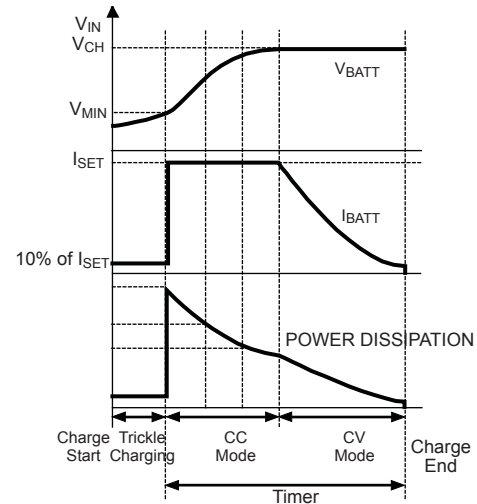

Figure 2—MP2608 Typical Charging Profile

Charge Termination and Auto-Recharge

At any time when V_{BATT} is 50mV higher than the trimmed charge target, the MP2608 reduces its charge current to 0 μ A. This ensures the safety of the battery. Also, the CV control loop always monitors the battery voltage such that it will automatically recharge the battery when it is depleted below the target level.

Upon V_{BATT} drops to 4.0V, the charger will automatically restart the charge cycle until the end of the timeout. When the input adapter is unplugged, there is only 1 μ A leakage current from battery drawn by the MP2608.

Programming of Charge Current and Battery Full Current

The Charge Current (I_{CHG}) of Adaptor input can be programmed from 0.1A to 1A by a resistor (R_{CHG}) connecting from the ICHG pin to GND. The relationship of the charge current and the programming resistance is established by the following table and graph.

The recommended resistance for programming the charge current is TBD. The battery full charge current threshold (I_{BF}) is programmed by connecting a resistor R_{BF} from the I_{BF} pin to GND:

$$I_{BF} = 1A \times 1.7k\Omega / R_{BF}$$

When the USB is selected as the power source, the charge current is fixed at a pre-set value 450mA, which is a typical value of USB current.

Table 1— R_{CHG} and I_{CHG} Relationship

| R_{CHG} (k Ω) | I_{CHG} (mA) |
|-------------------------|----------------|
| TBD | |

TBD

Figure 3—Charge Current vs. 1/RPGM Resistance

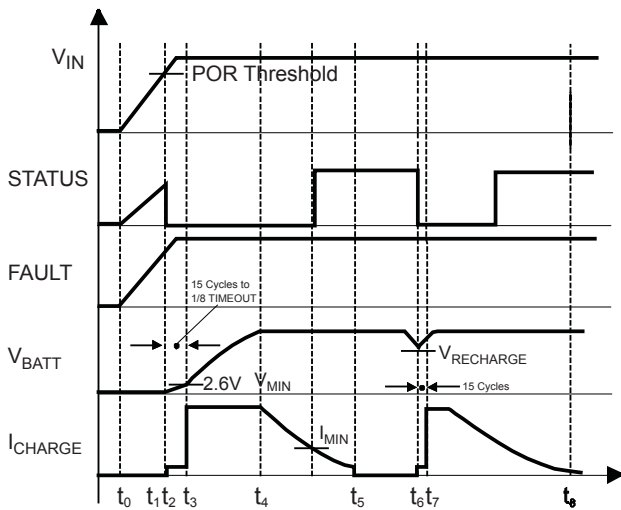

Figure 4—MP2608 Typical Re-Charging Waveforms

Charge Status and Fault Indication

The open drain pin \overline{STATUS} is used to indicate charging status. While battery is being charged, the \overline{STATUS} pin is pulled low, when the battery full condition is reached or any other condition prevents the charger from charging, the \overline{STATUS} pin will become a floating. \overline{STATUS} is then latched till a new charge cycle is started.

Upon a time-out fault event happen, the \overline{FAULT} pin is pulled low. When the V_{BATT} is lower than 2.6V for 1/8th of timeout period or the charging can not reach EOC status before the timeout happens, this fault status is latched, the charging is suspended, and the \overline{FAULT} pin is pulled low. To clear this fault, either the V_{IN} or V_{USB} should be recycled. One time-out period is equivalent to 2^{15} oscillator clock cycles. With a 1 μ F capacitor on the TMR pin, it takes 3.64 hours.

The Power On and recharge cycle are illustrated in Figure 4.

STATE DIAGRAM

NOTE: [] denotes the status of the PAD.
 Ex) [STATUS] means the STATUS pad is pulled-up. Low state is not specified in the bubble.

V_{POR} : Power-on-reset Threshold.
 V_{TRK} : Trickle Charge Thres.
 V_{RECH} : Recharge Thres.

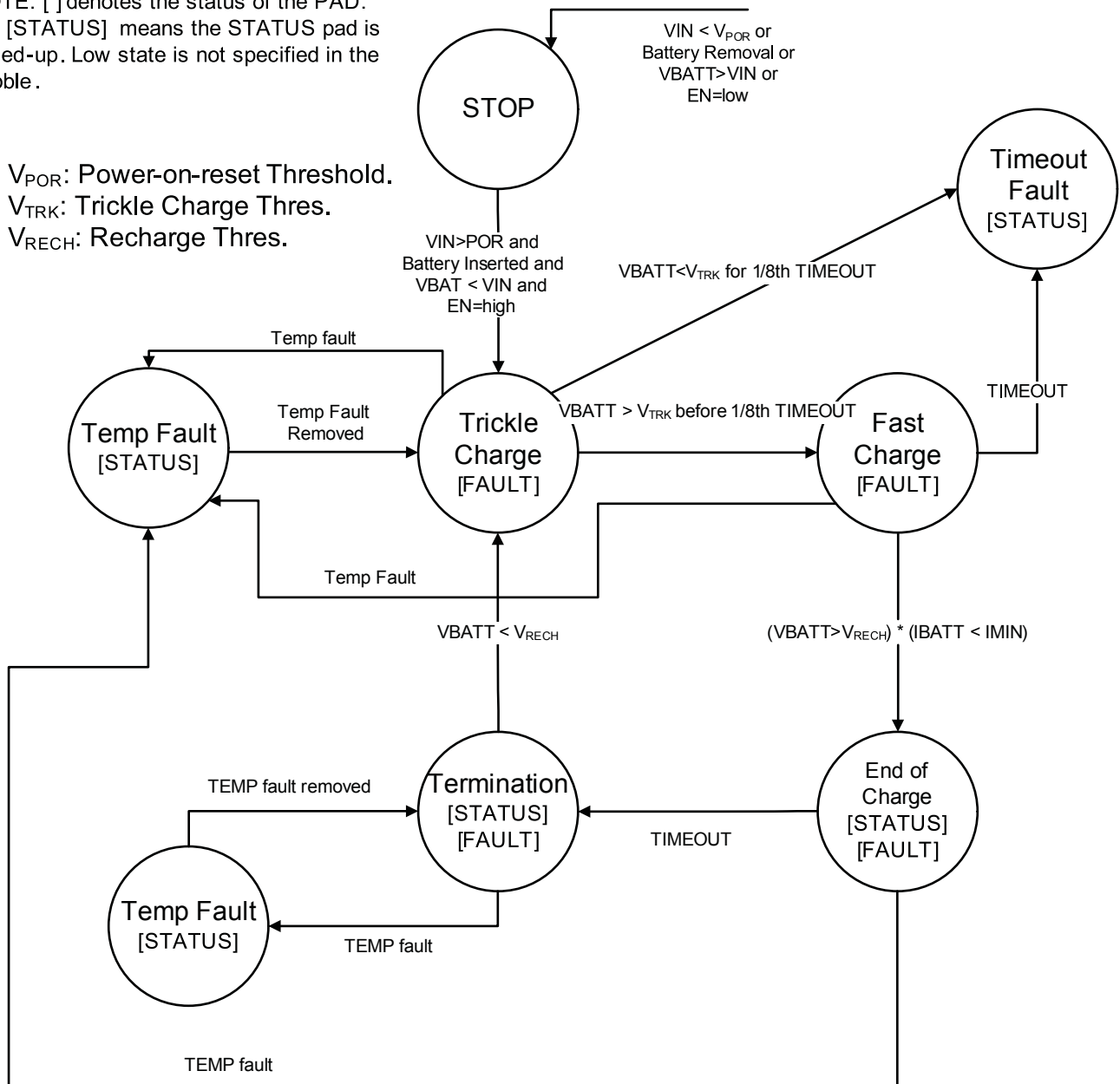
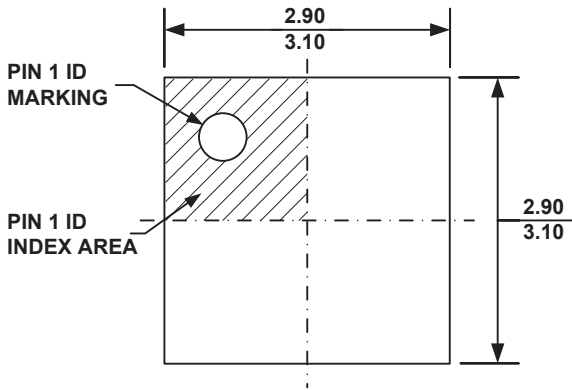

Figure 5—MP2608 State Diagram

PACKAGE INFORMATION

QFN10 (3mm x 3mm)



TOP VIEW

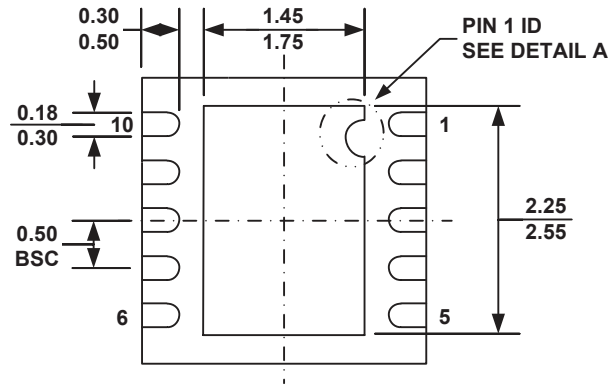

BOTTOM VIEW

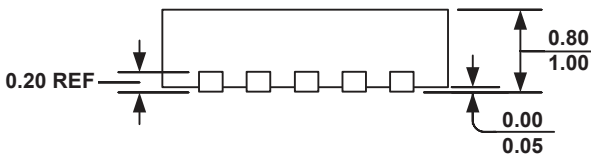

SIDE VIEW

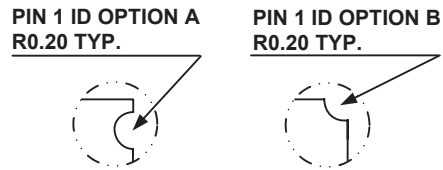

DETAIL A

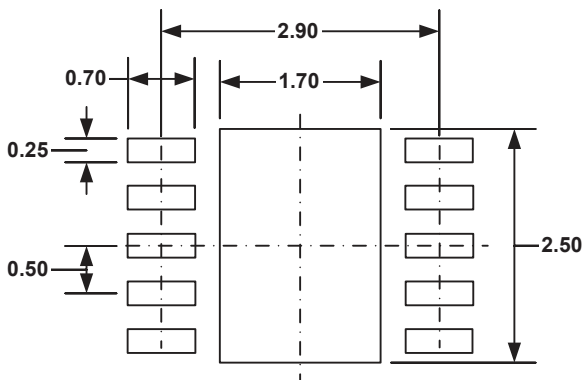

RECOMMENDED LAND PATTERN

NOTE:

- 1) ALL DIMENSIONS ARE IN MILLIMETERS.
- 2) EXPOSED PADDLE SIZE DOES NOT INCLUDE MOLD FLASH.
- 3) LEAD COPLANARITY SHALL BE 0.10 MILLIMETER MAX.
- 4) DRAWING CONFORMS TO JEDEC MO-229, VARIATION VEED-5.
- 5) DRAWING IS NOT TO SCALE.

NOTICE: The information in this document is subject to change without notice. Users should warrant and guarantee that third party Intellectual Property rights are not infringed upon when integrating MPS products into any application. MPS will not assume any legal responsibility for any said applications.