

## Evaluation Board Report

### 12V 8.4W ACDC power supply

Design Specs	Value	Unit
Input Voltage	85-265	VAC
Output Voltage	12	VDC
Output Current	0.7	A
Isolation	YES	
MPS IC	MP020-5GS	
Application	<ul style="list-style-type: none"> <li>• Small Home Appliances</li> <li>• Cell Phone Chargers</li> <li>• Adapters for Handheld Electronics</li> <li>• Stand-By and Auxiliary Power Supplies</li> <li>• Small Appliances</li> </ul>	

Document Number	EBXXX
Author	Application Engineering Department
Date	Nov, 2014
Revision	1.0

### Design Summary

EV020-5-S-00B evaluation board provides a reference design for a universal offline power supply with 12V,0.7A output. It contains the complete specification of the power supply, a detailed circuit diagram, the entire bill of materials required to build the power supply, drawing of the power inductors and transformers, and test data of the most important performance.

## DESCRIPTION

The EV020-5-S-00B Evaluation Board is designed to demonstrate the capabilities of MP020-5. The MP020-5 is a primary-side-control offline regulator which can eliminate secondary feedback components.

The EV020-5-S-00B is typically designed for small home appliances which output 12V, 0.7A load from 85VAC to 265VAC, 50HZ/60HZ.

The EV020-5-S-00B has an excellent efficiency and meets IEC61000-4-5 surge immunity and EN55022 conducted EMI requirements. It has multi-protection function as open circuit protection, short-circuit protection, cycle by cycle current limit and over-temperature protection, etc.

## ELECTRICAL SPECIFICATION

Parameter	Symbol	Value	Units
Input Voltage	$V_{IN}$	85 to 265	VAC
Output Voltage	$V_{OUT}$	12	V
Output Current	$I_{OUT}$	0.7	A
Output Power	$P_{OUT}$	8.4	W
Efficiency (full load)	$\eta$	>80	%

## FEATURES

- Primary-Side–Control without Opto-Coupler or Secondary Feedback Circuit
- Precise Constant Current and Constant Voltage Control (CC/CV)
- Integrated 700V MOSFET with Minimal External Components
- Variable, Off-Time, Peak-Current Control
- 550 $\mu$ A High-Voltage Current Source
- 100mW No-Load Power Consumption
- Programmable Cable Compensation
- Multiple Protections: OVP, OCP, OCKP, OTP, and VCC UVLO
- Natural Spectrum Shaping for Improved EMI Signature
- Low Cost and Simple External circuit

## APPLICATIONS

- Small Home Appliances
- Cell Phone Chargers
- Adapters for Handheld Electronics
- Stand-By and Auxiliary Power Supplies
- Small Appliances

All MPS parts are lead-free and adhere to the RoHS directive. For MPS green status, please visit MPS website under Quality Assurance. "MPS" and "The Future of Analog IC Technology", are Registered Trademarks of Monolithic Power Systems, Inc.



**Warning:** Although this board is designed to satisfy safety requirements, the engineering prototype has not been agency approved. Therefore, all testing should be performed using an isolation transformer to provide the AC input to the prototype board.

## EV020-5-S-00B EVALUATION BOARD

**TOP VIEW**



**BOTTOM VIEW**

(L x W x H) 50mm x 30mm x 18mm

Board Number	MPS IC Number
EV020-5-S-00B	MP020-5GS

# EVALUATION BOARD SCHEMATIC

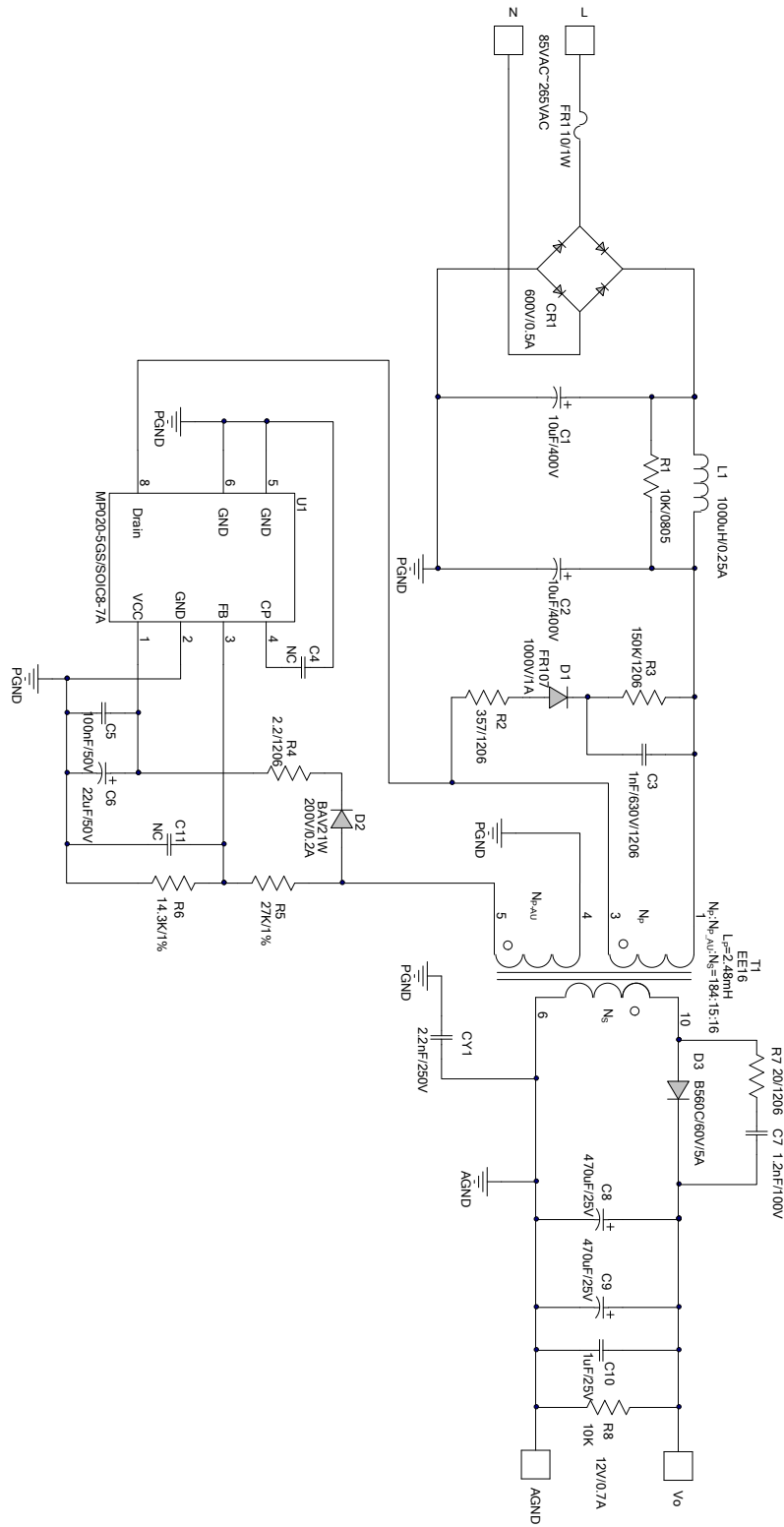

Figure 1—Schematic

**PCB LAYOUT (SINGLE-SIDED)**

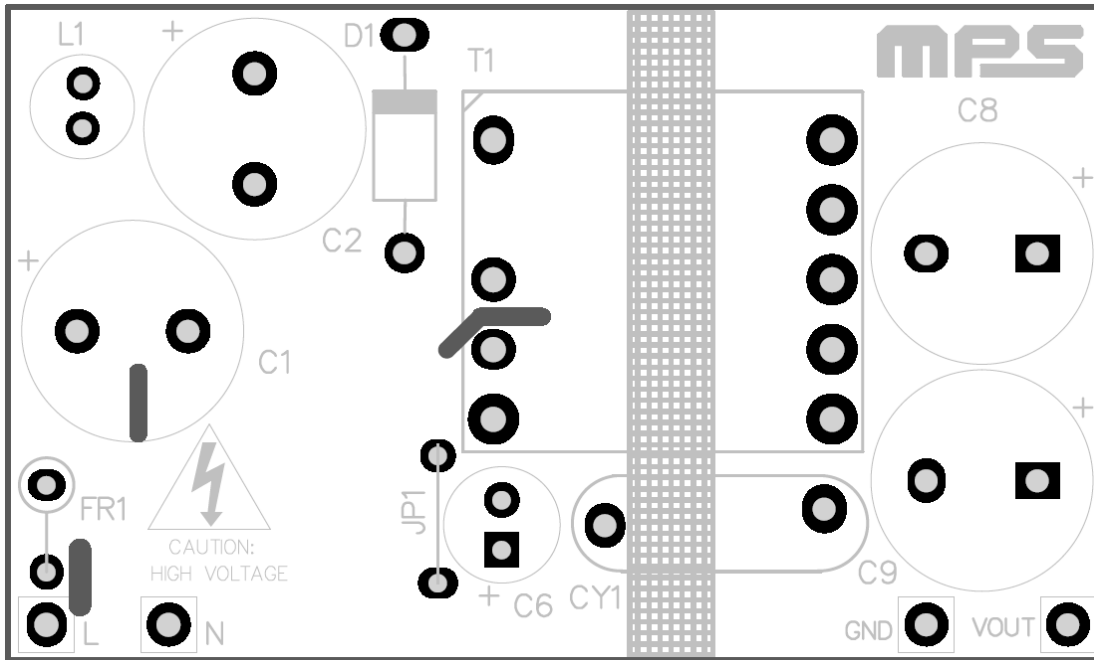

Figure 2—Top Layer

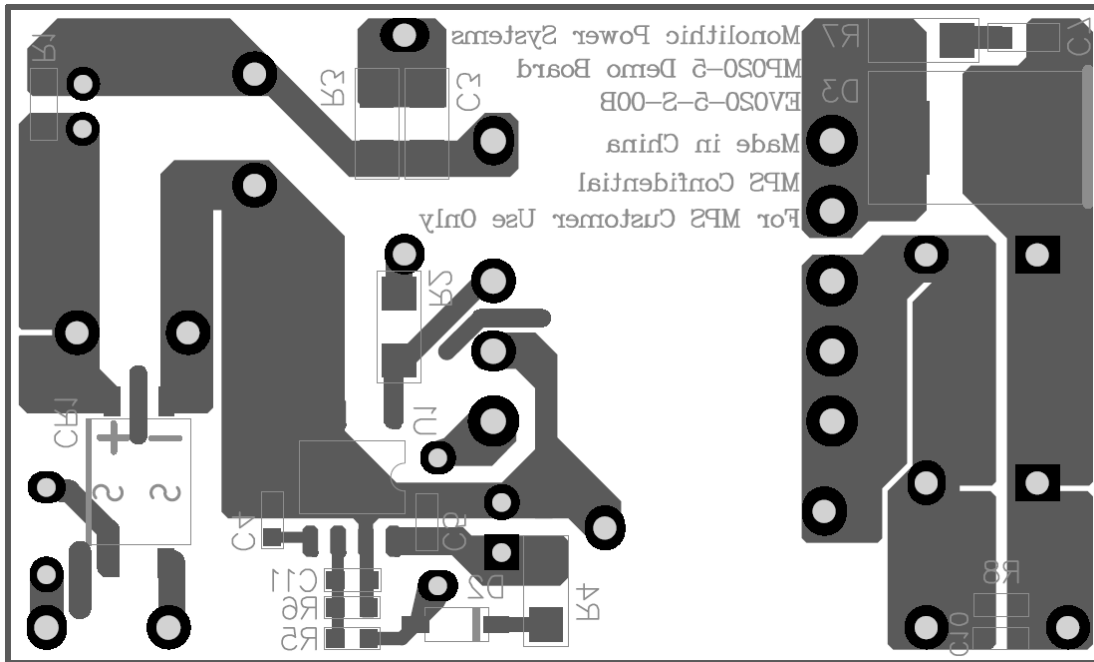

Figure 3—Bottom Layer

## CIRCUIT DESCRIPTION

The EV020-5-S-00B is configured in a single-stage Flyback topology, it uses primary-side-control which can mostly simplify the schematic and get a cost effective BOM. It can also achieve accurate constant voltage and constant current.

FR1 and CR1 compose the input stage. FR1 is used to protect for the component failure or some excessive short events, also it can restrain the inrush current.

C1, L1 and C2 compose  $\pi$  filter to guarantee the conducted EMI meet standard EN55022. R2, R3, D1 and C3 compose the snubber circuit to reduce drain-source voltage spike.

R4, C5, C6 and D2 are used as Vcc power supply.

R5 and R6 are resistor divider for detecting output voltage by sampling voltage on primary auxiliary winding.

CY1 is Y capacitor lowering common mode noise to make sure there is enough EMI margin. T1 is power transformer, the structure of which is also very important to pass EMI test.

D3, C8, C9, C10 and R8 compose output circuit. D3 is schottky diode for better efficiency. C10 is ceramic capacitor for lower output voltage ripple and R8 is dummy load, which is used for good regulation.

R7 and C7 are used to depress the spike of schottky.

**EV020-5-S-00B BILL OF MATERIALS**

Qty	Ref	Value	Description	Package	Manufacturer	Manufacturer_P/N
2	C1,C2	10 $\mu$ F	Capacitor;400V;20%	DIP	Ltec	TY 10uF/400V
1	C3	1nF	Ceramic Capacitor;630V;X7R	1206	Murata	GRM31A7U2J102JW31D
1	C4	0 $\Omega$	Film Resistor;5%	0603	Yageo	RC0603JR-070RL
1	C5	100nF	Ceramic Capacitor;50V;X7R;	0603	Murata	GCJ188R71H104KA12D
1	C6	22 $\mu$ F	Electrolytic Capacitor;50V	DIP	Jianghai	CD281L-50V22
1	C7	1.2nF	Ceramic Capacitor;100V;X7R	0603	muRata	GRM188R72A122KA01D
2	C8,C9	470 $\mu$ F	Electrolytic Capacitor;25V,Low ESR	DIP	Rubycon	25ZLF470MEFC10X12.5
1	C10	1 $\mu$ F	Ceramic Capacitor;25V;X7R	0603	Murata	GRM188R71E105KA12D
1	C11	NC				
1	CY1	2.2nF	Y Capacitor; 250V	DIP	Hongke	JNK12E222ML02N
1	CR1	MB6F	Diode;600V;0.5A	SOP-4	Diodes	MB6F
1	D1	FR107	Diode;1000V;1A	DO-41	Diodes	FR107
1	D2	BAV21W	Diode;200V;0.2A;	SOD-123	Diodes	BAV21W-7-F
1	D3	B560C	Schottky Diode;60V;5A	SMC	Diodes	B560C
1	FR1	10 $\Omega$	Fusible Resistor, 1 W, 5%	Yageo	DIP	FKN1WSJT-52-10R
1	L1	1000 $\mu$ H	Inductor;1000uH;6 Ohm;0.25A	DIP	Wurth	7447462102
1	R1	10k $\Omega$	Film Resistor;5%	0805	Yageo	RC0805JR-0710KL
1	R2	357 $\Omega$	Film Resistor;1%;1/4W	1206	Yageo	RC1206FR-07357RL
1	R3	150k $\Omega$	Film Resistor; 1%,1/4W	1206	Yageo	RC1206FR-07150KL
1	R4	2.2 $\Omega$	Film Resistor;5%;1/4W	1206	Royalohm	1206F220KT5E
1	R5	27k $\Omega$	Film Resistor;1%;	0603	Yageo	RC0603FR-0727KL
1	R6	14.3k $\Omega$	Film Resistor;1%	0603	Yageo	RC0603FR-0714K3L
1	R7	20 $\Omega$	Film Resistor;5%;1/4W	1206	Royalohm	1206J0200T5E
1	R8	10k $\Omega$	Film Resistor;5%;	0603	Yageo	RC0603JR-0710K
1	U1		Primary side regulator	SOIC8-7A	MPS	MP020-5GS R3
1	T1		Transformer;2.48mH; N <sub>P</sub> :N <sub>P_AU</sub> :N <sub>S</sub> =184:15:16	EE16	Würth <sup>(1)</sup>	7508110328
					Emei <sup>(2)</sup>	FX0303
<b>Notes:</b>		(1) Würth transformer sample request please login on website: <a href="http://www.we-online.com">www.we-online.com</a>				
		(2) Emei transformer sample request please login on website: <a href="http://www.emeigroup.com">www.emeigroup.com</a>				

## TRANSFORMER SPECIFICATION

### Electrical Diagram

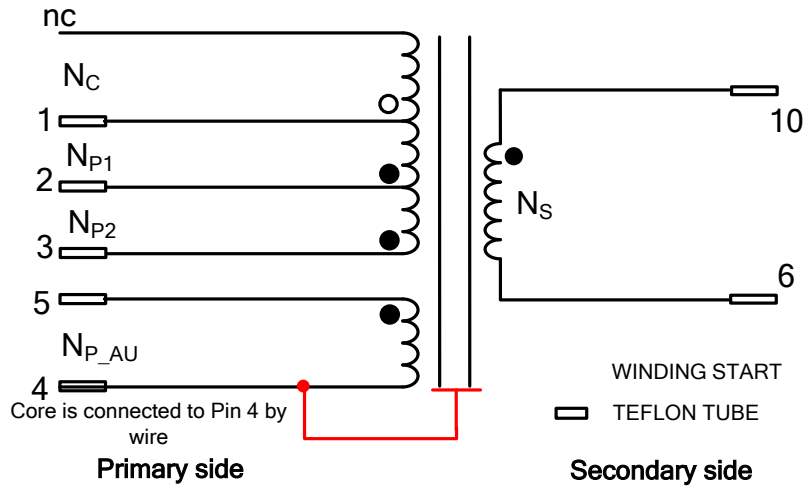

Figure 4—Transformer Electrical Diagram

#### Notes:

- 1) Core is connected with Pin 4 with naked wire.
- 2)  $N_s$  is with Triple Insulation Wire.

### Winding Diagram

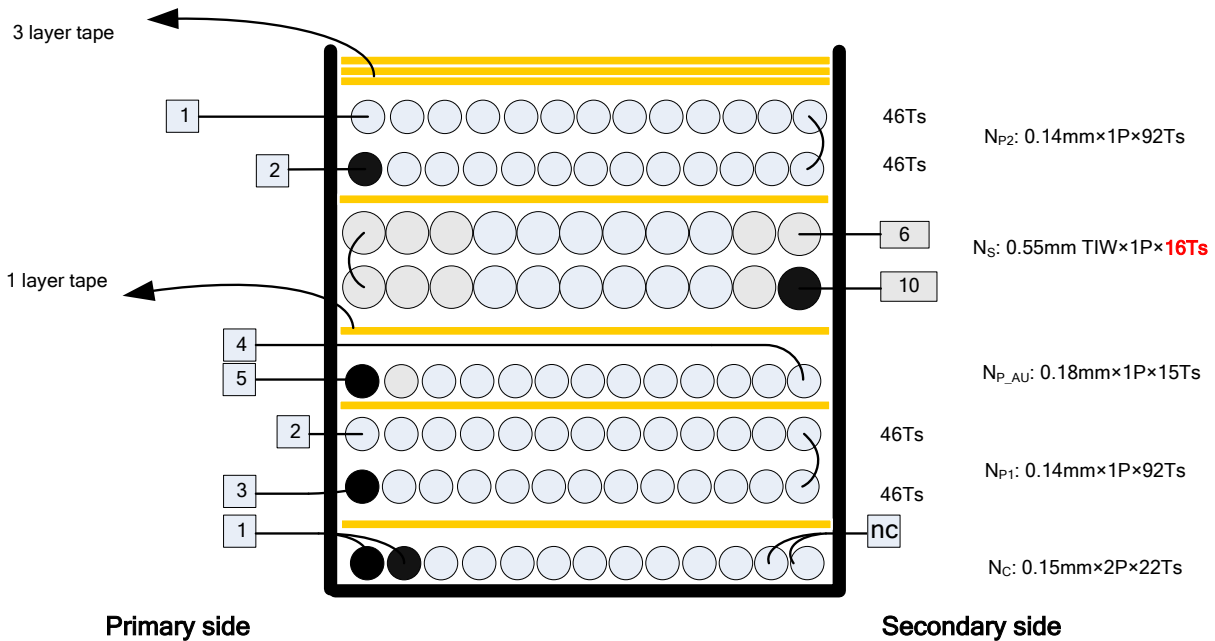

Figure 5—Winding Diagram



### Winding Order

Winding No.	Tape Layer Number	Start & End	Magnet Wire $\Phi$ (mm)	Turns
N <sub>C</sub>	1	1→nc	0.15mm * 2	22
N <sub>P1</sub>	1	3→2	0.14mm * 1	92
N <sub>P_AU</sub>	1	5→4	0.18mm * 1	15
N <sub>S</sub>	1	10→6	0.55mm * 1 TIW	16
N <sub>P2</sub>	1	2→1	0.14mm * 1	92

### Electrical Specifications

<b>Electrical Strength</b>	60 second, 60Hz, from PRI. to SEC.	3000VAC
	60 second, 60Hz, from PRI. to CORE.	500VAC
	60 second, 60Hz, from SEC. to CORE.	3000VAC
<b>Primary Inductance</b>	Pins 1 - 3, all other windings open, measured at 50kHz, 0.1 VRMS	2.48mH±10%
<b>Primary Leakage Inductance</b>	Pins 1 - 3 with all other pins shorted, measured at 50kHz. 0.1 VRMS	60μH±10%

### Materials

Item	Description
1	Core: EE16, UI=2300±25%, AL=73.2.4nH/N <sup>2</sup> ±3% GAPPED, or equivalent
2	Bobbin: EE16, 5+5PIN 1 SECT TH, UL94V-0
3	Wire: $\Phi$ 0.14mm,, 2UEW, Class B
4	Wire: $\Phi$ 0.15mm,, 2UEW, Class B
5	Wire: $\Phi$ 0.18mm,, 2UEW, Class B
6	Triple Insulation Wire: $\Phi$ 0.55mm TIW
7	Tape: 8.0mm(W)×0.06mm(TH)
8	Varnish: JOHN C. DOLPH CO, BC-346A or equivalent

## EVB TEST RESULTS

### Performance Data

$T_A=25^\circ\text{C}$ , unless otherwise noted.

#### Efficiency

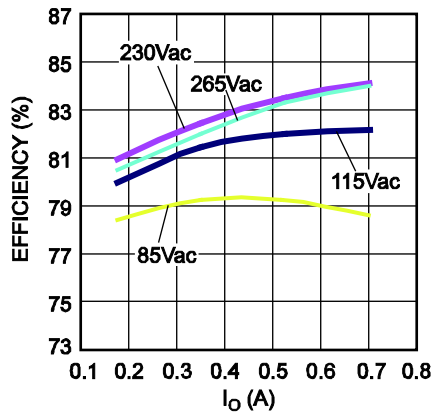

#### No Load Consumption

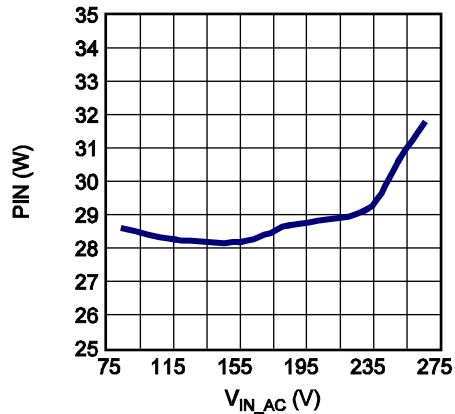

#### Line Regulation

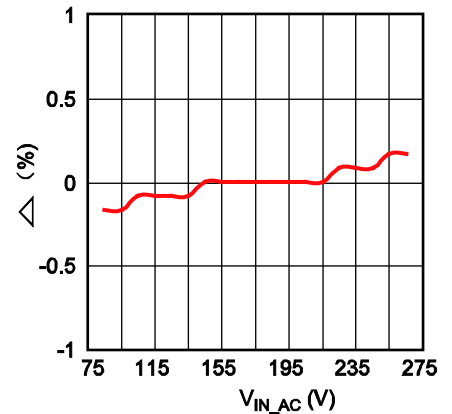

#### Load Regulation

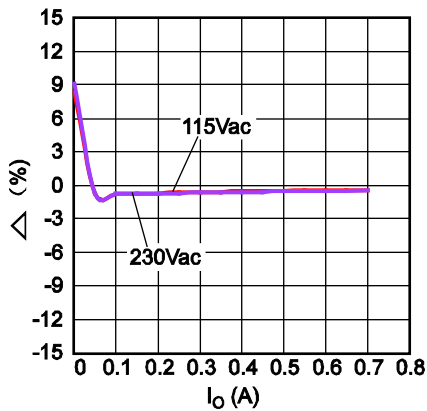

**Electric Strength Test**

Primary circuit to secondary circuit electric strength testing was completed according to IEC61000-4-2. Input and output was shorted respectively. 3000VAC/50Hz sine wave applied between input and output for 1min, and operation was verified.

**Surge Test**

Line to Line 1kV and Line to Power Earth 1kV surge testing was completed according to IEC61000-4-5. Input voltage was set at 220VAC/50Hz. Output was loaded at full load and operation was verified following each surge event.

Surge Level (V)	Input Voltage (VAC)	Injection Location	Injection Phase (°)	Test Result (Pass/Fail)
1000	220	L to N	90	Pass
-1000	220	L to N	270	Pass
1000	220	L to PE	90	Pass
-1000	220	L to PE	270	Pass
1000	220	N to PE	90	Pass
-1000	220	N to PE	270	Pass

**Conducted EMI Test**

Test with 230Vac input and full load condition

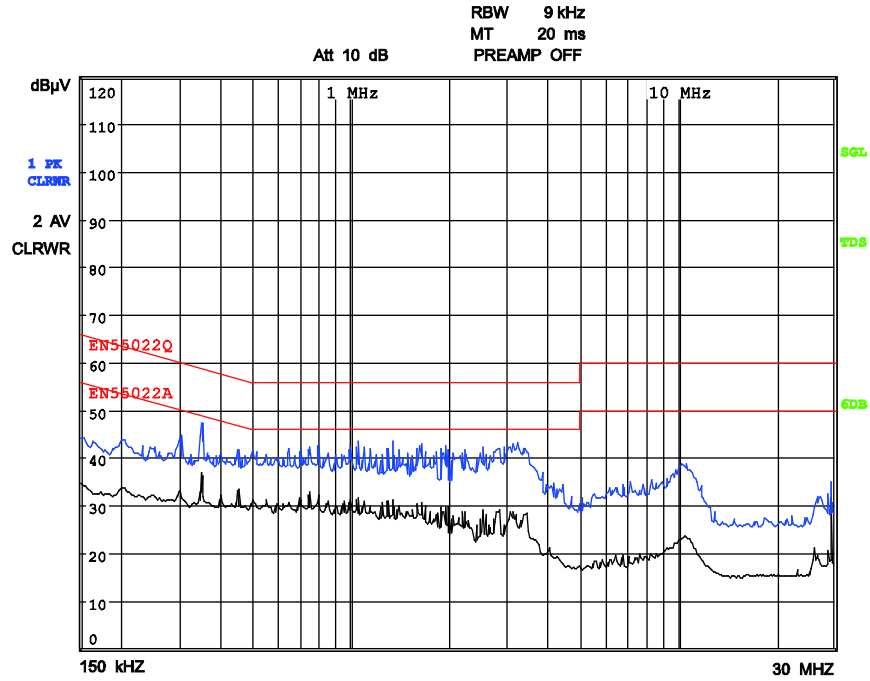

**230Vac, 50Hz, Maximum Load, L Line, EN55022 Limits**

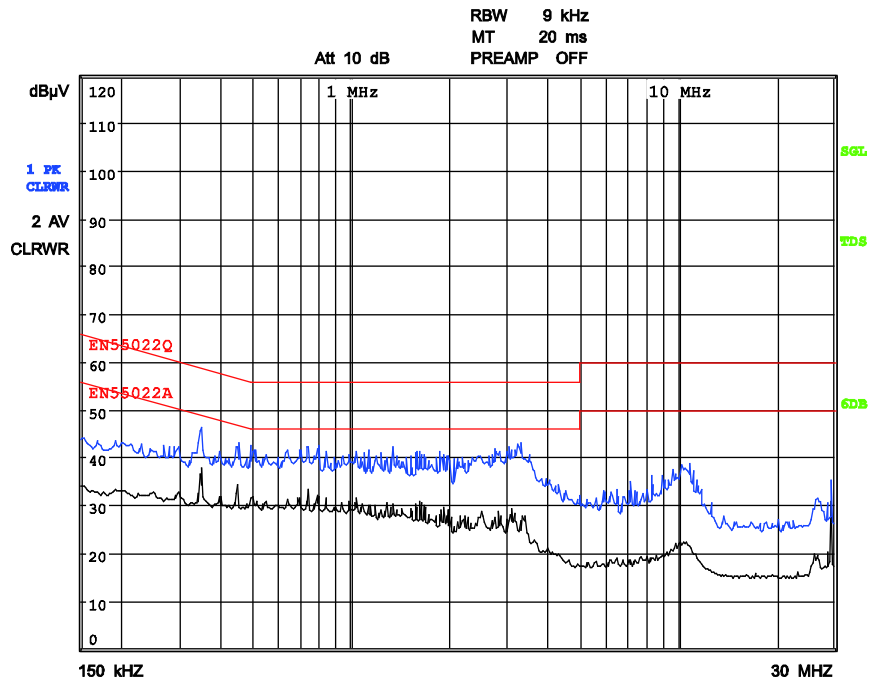

**230Vac, 50Hz, Maximum Load, N Line, EN55022 Limits**

**Conducted EMI Test (continued)**

Test with 115Vac input and full load condition

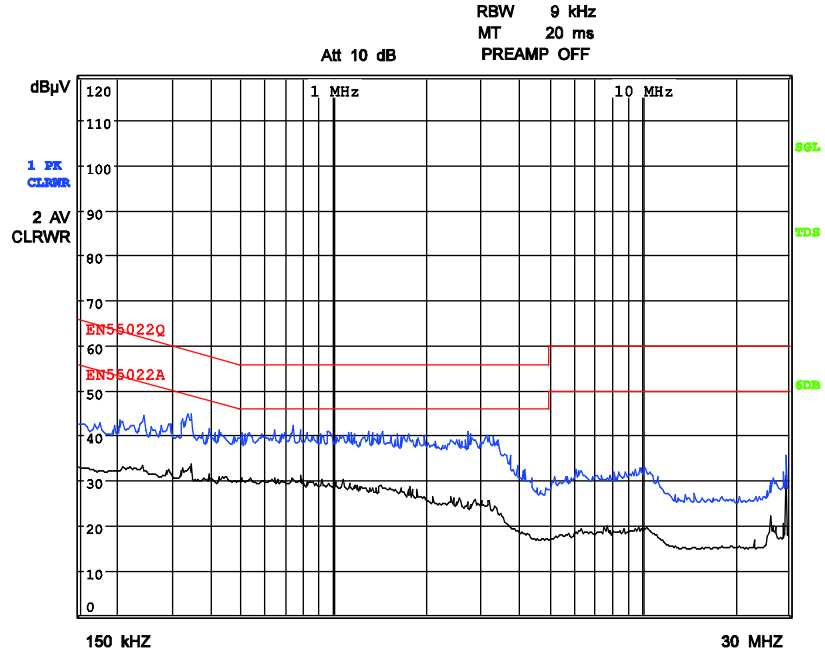

**115Vac, 60Hz, Maximum Load, L Line, EN55022 Limits**

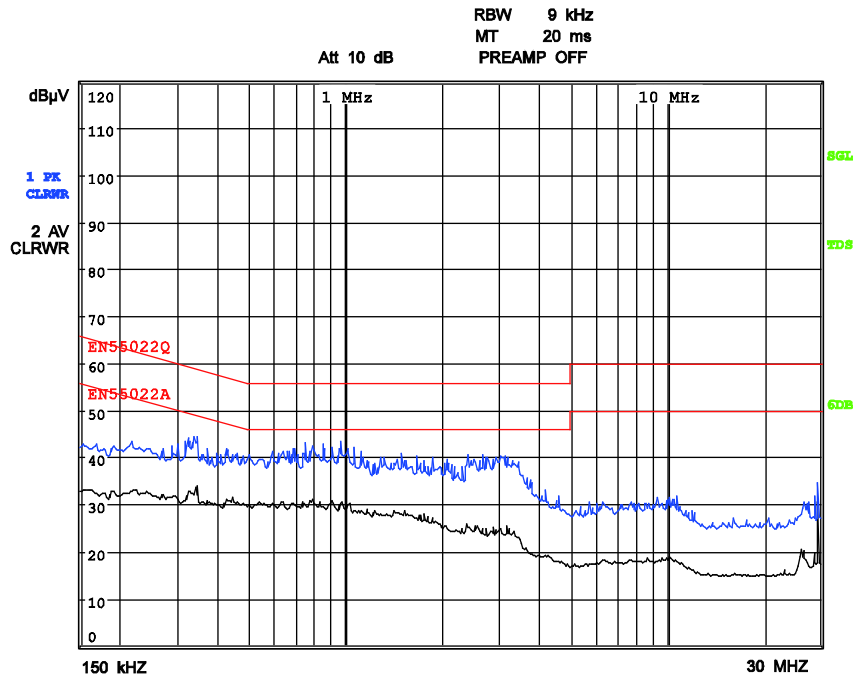

**115Vac, 60Hz, Maximum Load, N Line, EN55022 Limits**

**Thermal Test**

Test with 85Vac input and full load condition. PCB layout is with 1Oz copper. Ambient temperature is 25°C.

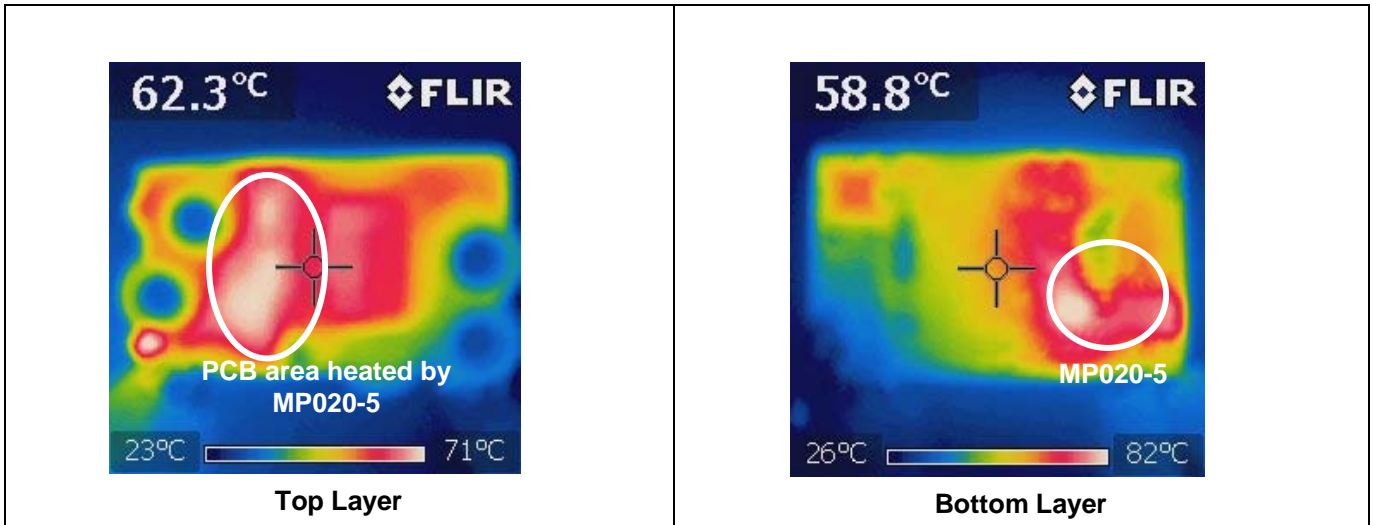

Test with 265Vac input and full load condition. PCB layout is with 1Oz copper. Ambient temperature is 25°C.

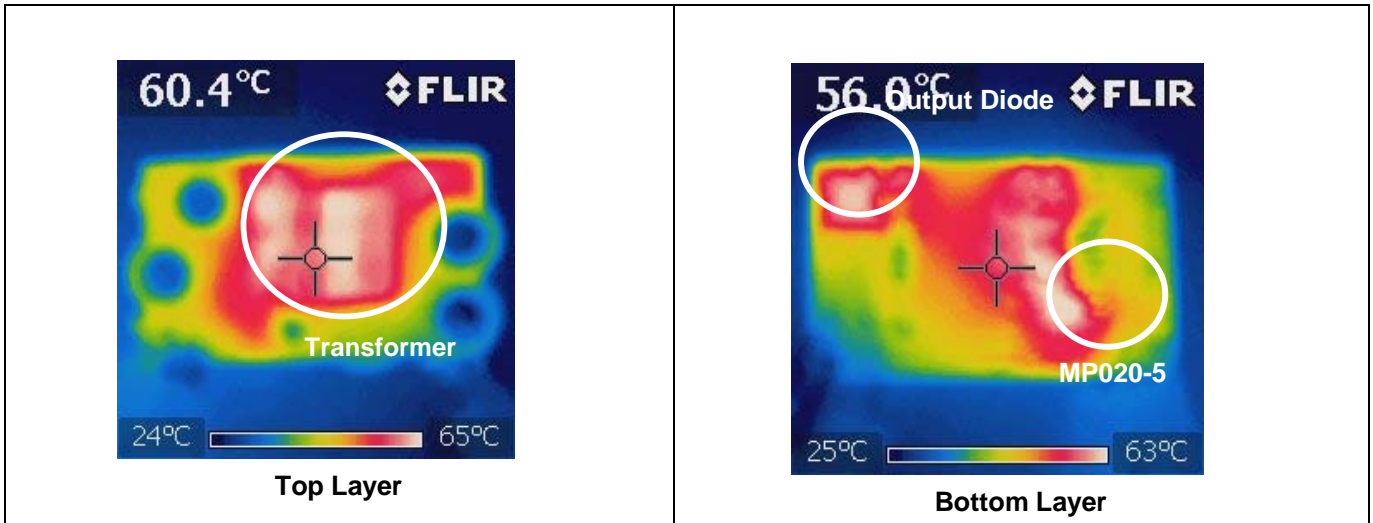

**Temperature Chamber Test**

The EVB setup in constant temperature chamber with full load and 85Vac input. Full load (0.7A) output in 85°C ambient temperature will trigger the OTP.

**MP020-5 Case Temp vs. Ambient Temp**

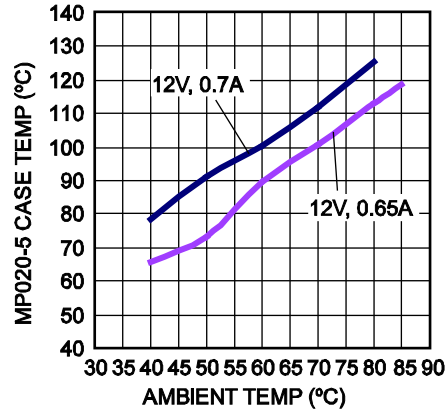

## EVB TEST RESULTS

Performance waveforms are tested on the evaluation board.

$V_{IN}=115VAC/60Hz$ ,  $V_{OUT}=12V$ ,  $I_{OUT}=0.7A$ ,  $L_P=2.48mH$ ,  $N_P:N_{P\_AU}:N_S=184:15:16$ ,  $T_A=25^\circ C$ , unless otherwise noted.

**Steady State**

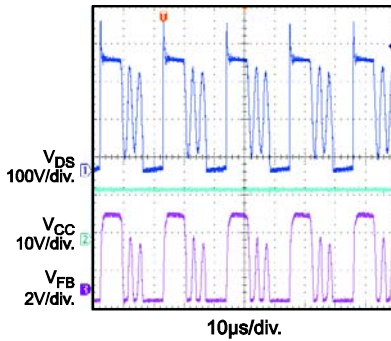

**Turn On Delay**

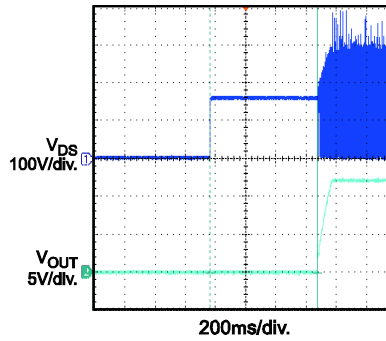

**Output Rise Time**

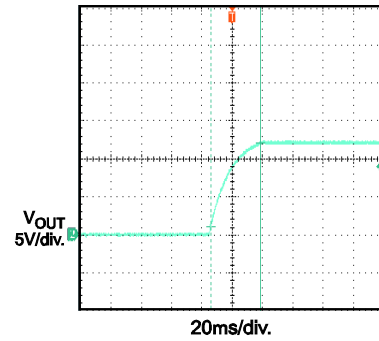

**Output Ripple**

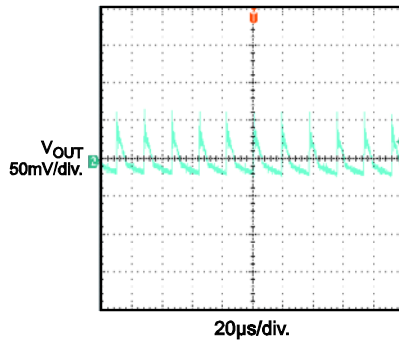

**SCP Enter**

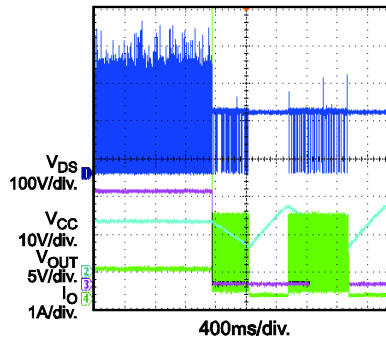

**SCP Recovery**

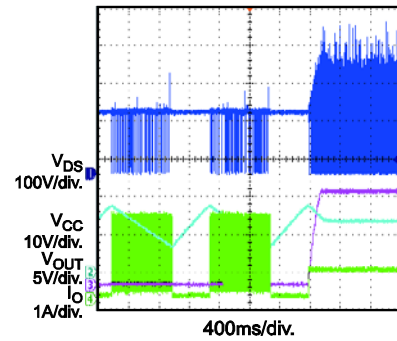

**OckP Enter**

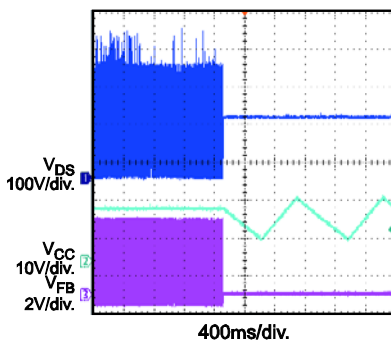

**OckP Recovery**

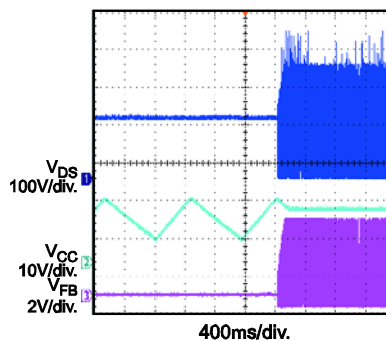

**OLP Enter**

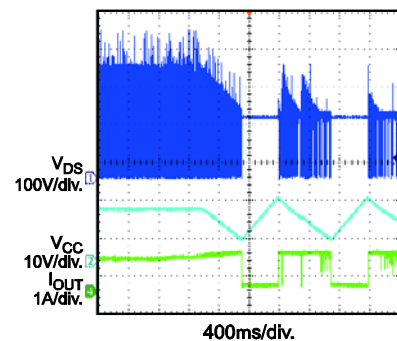



## EVB TEST RESULTS *(continued)*

Performance waveforms are tested on the evaluation board.

$V_{IN}=115VAC/60Hz$ ,  $V_{OUT}=12V$ ,  $I_{OUT}=0.7A$ ,  $L_P=2.48mH$ ,  $N_P:N_{P\_AU}:N_S=184:15:16$ ,  $T_A=25^\circ C$ , unless otherwise noted.

### OLP Recovery

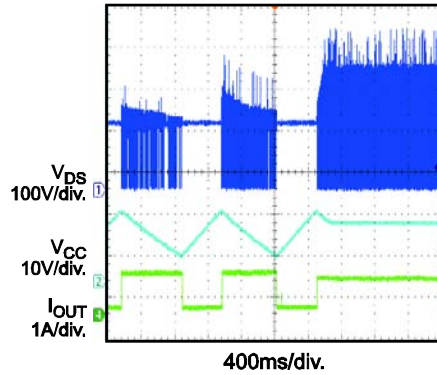

### Load Transient

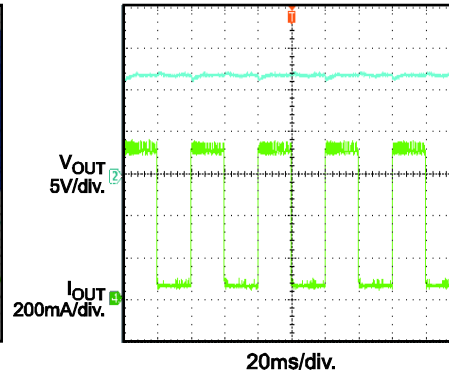

## EVB TEST RESULTS *(continued)*

Performance waveforms are tested on the evaluation board.

$V_{IN}=230VAC/50Hz$ ,  $V_{OUT}=12V$ ,  $I_{OUT}=0.7A$ ,  $L_P=2.48mH$ ,  $N_P:N_{P\_AU}:N_S=184:15:16$ ,  $T_A=25^\circ C$ , unless otherwise noted.

**Steady State**

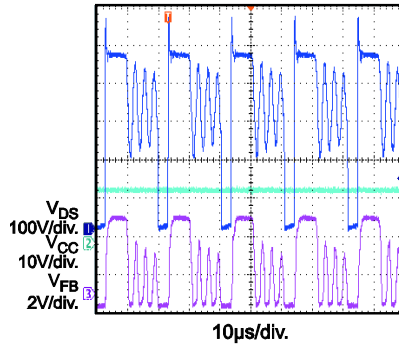

**Turn On Delay**

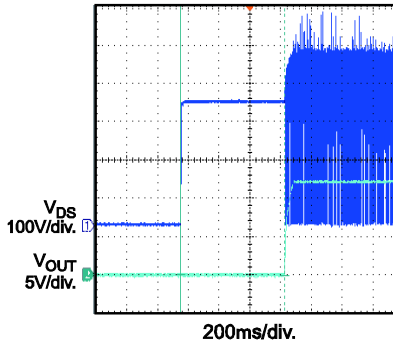

**Output Rise Time**

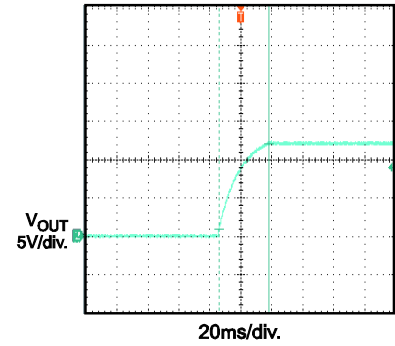

**Output Ripple**

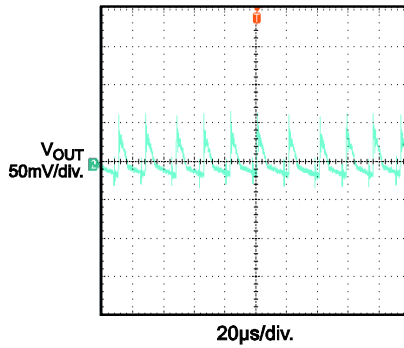

**SCP Enter**

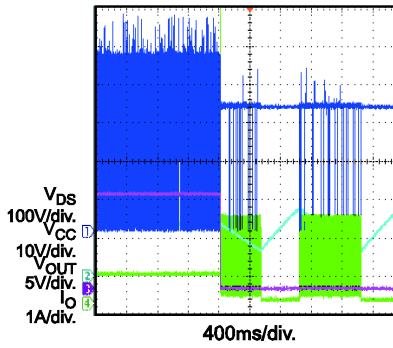

**SCP Recovery**

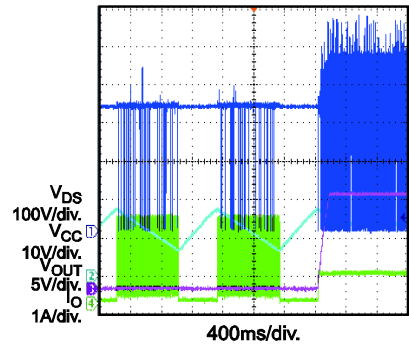

**OCP Enter**

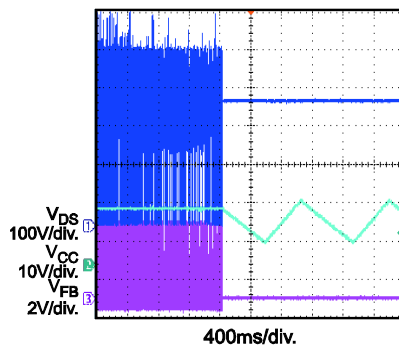

**OCP Recovery**

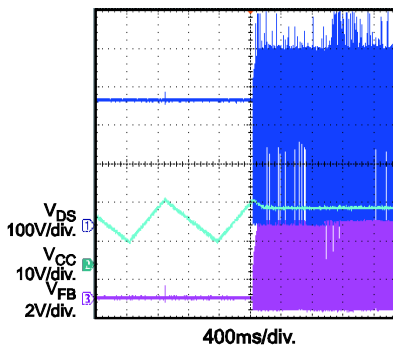

**OLP Enter**

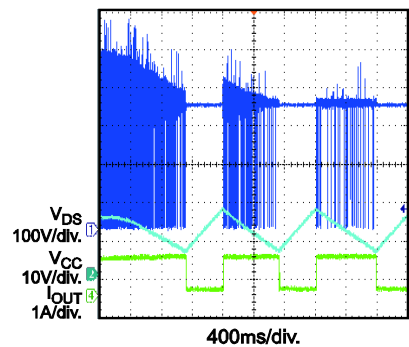

## EVB TEST RESULTS *(continued)*

Performance waveforms are tested on the evaluation board.

$V_{IN}=230VAC/50Hz$ ,  $V_{OUT}=12V$ ,  $I_{OUT}=0.7A$ ,  $L_P=2.48mH$ ,  $N_P:N_{P\_AU}:N_S=184:15:16$ ,  $T_A=25^\circ C$ , unless otherwise noted.

### OLP Recovery

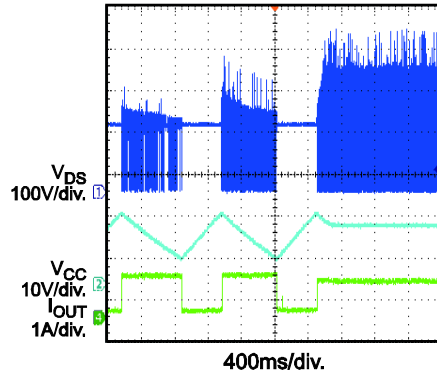

### Load Transient

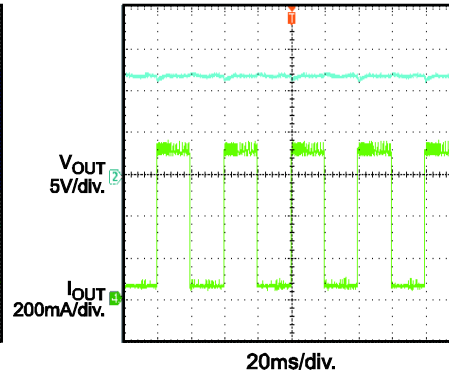

## QUICK START GUIDE

1. Preset Power Supply to  $85\text{VAC} \leq V_{\text{IN}} \leq 265\text{VAC}$ .
2. Turn Power Supply off.
3. Connect the Line and Neutral terminals of the power supply output to L and N port. For three-wire input application, make OUTPUT GND connected to Earth.
4. Connect Load to:
  - a. Positive (+): VOUT
  - b. Negative (-): GND
5. Turn Power Supply on after making connections.

## Contact Information

To request this evaluation board, please refer to your local sales offices which can be found from:

<http://www.monolithicpower.com/Company/Contact-Us>

## Disclaimer

Monolithic Power Systems (MPS) reserves the right to make changes to its products and to discontinue products without notice. The applications information, schematic diagrams, and other reference information included herein is provided as a design aid only and are therefore provided as-is. MPS makes no warranties with respect to this information and disclaims any implied warranties of merchantability or non-infringement of third-party intellectual property rights.

MPS cannot assume responsibility for use of any circuitry other than circuitry entirely embodied in a MPS product. No circuit patent licenses are implied.

Certain applications using semiconductor products may involve potential risks of death, personal injury, or severe property or environmental damage (“Critical Applications”).

**MPS PRODUCTS ARE NOT DESIGNED, INTENDED, AUTHORIZED, OR WARRANTED TO BE SUITABLE FOR USE IN LIFE-SUPPORT APPLICATIONS, DEVICES OR SYSTEMS, OR OTHER CRITICALAPPLICATIONS.**

Inclusion of MPS products in critical applications is understood to be fully at the risk of the customer. Questions concerning potential risk applications should be directed to MPS.

MPS semiconductors are typically used in power supplies in which high voltages are present during operation. High voltage safety precautions should be observed in design and operation to minimize the chance of injury.

**NOTICE:** The information in this document is subject to change without notice. Please contact MPS for current specifications. Users should warrant and guarantee that third party Intellectual Property rights are not infringed upon when integrating MPS products into any application. MPS will not assume any legal responsibility for any said applications.