

Evaluation Board Report

5V 5W ACDC power supply

| Design Specs | Value | Unit |
|----------------|---|------|
| Input Voltage | 85-265 | VAC |
| Output Voltage | 5 | VDC |
| Output Current | 1 | A |
| Isolation | YES | |
| MPS IC | MP020-5GS | |
| Application | <ul style="list-style-type: none"> • Cell Phone Chargers • Adapters for Handheld Electronics • Stand-By and Auxiliary Power Supplies • Small Appliances | |

| | |
|-----------------|------------------------------------|
| Document Number | EBXXX |
| Author | Application Engineering Department |
| Date | Nov, 2014 |
| Revision | 1.0 |

Design Summary

EV020-5-S-00A evaluation board provides a reference design for a universal offline power supply with 5V, 1A output. It contains the complete specification of the power supply, a detailed circuit diagram, the entire bill of materials required to build the power supply, drawing of the power inductors and transformers, and test data of the most important performance.

DESCRIPTION

The EV020-5-S-00A Evaluation Board is designed to demonstrate the capabilities of MP020-5. The MP020-5 is a primary-side-control regulator which can eliminate secondary feedback components.

The EV020-5-S-00A is typically designed for cell phone which output 5V, 1A load from 85VAC to 265VAC, 50HZ/60HZ.

The EV020-5-S-00A has an excellent efficiency and meets IEC61000-4-5 surge immunity and EN55022 conducted EMI requirements. It has multi-protection function as open circuit protection, short-circuit protection, cycle by cycle current limit and over-temperature protection, etc.

ELECTRICAL SPECIFICATION

| Parameter | Symbol | Value | Units |
|------------------------|-----------|-----------|-------|
| Input Voltage | V_{IN} | 85 to 265 | VAC |
| Output Voltage | V_{OUT} | 5 | V |
| Output Current | I_{OUT} | 1 | A |
| Output Power | P_{OUT} | 5 | W |
| Efficiency (full load) | η | >70 | % |

FEATURES

- Primary-Side-Control without Opto-Coupler or Secondary Feedback Circuit
- Precise Constant Current and Constant Voltage Control (CC/CV)
- Integrated 700V MOSFET with Minimal External Components
- Variable, Off-Time, Peak-Current Control
- 550 μ A High-Voltage Current Source
- 30mW No-Load Power Consumption
- Programmable Cable Compensation
- Multiple Protections: OVP, OCP, OCPK, OTP, and VCC UVLO
- Natural Spectrum Shaping for Improved EMI Signature
- Low Cost and Simple External circuit

All MPS parts are lead-free and adhere to the RoHS directive. For MPS green status, please visit MPS website under Quality Assurance. "MPS" and "The Future of Analog IC Technology" are Registered Trademarks of Monolithic Power Systems, Inc.



High Voltage

Warning: Although this board is designed to satisfy safety requirements, the engineering prototype has not been agency approved. Therefore, all testing should be performed using an isolation transformer to provide the AC input to the prototype board.

EV020-5-S-00A EVALUATION BOARD



TOP VIEW

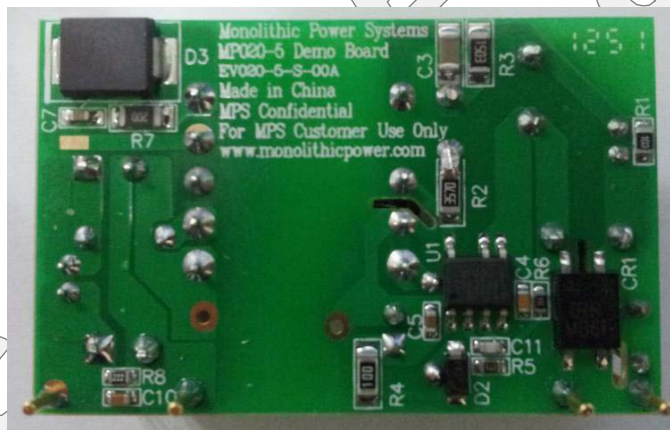

BOTTOM VIEW

(L x W x H) 47mm x 30mm x 18mm

| Board Number | MPS IC Number |
|---------------|---------------|
| EV020-5-S-00A | MP020-5GS |

EVALUATION BOARD SCHEMATIC

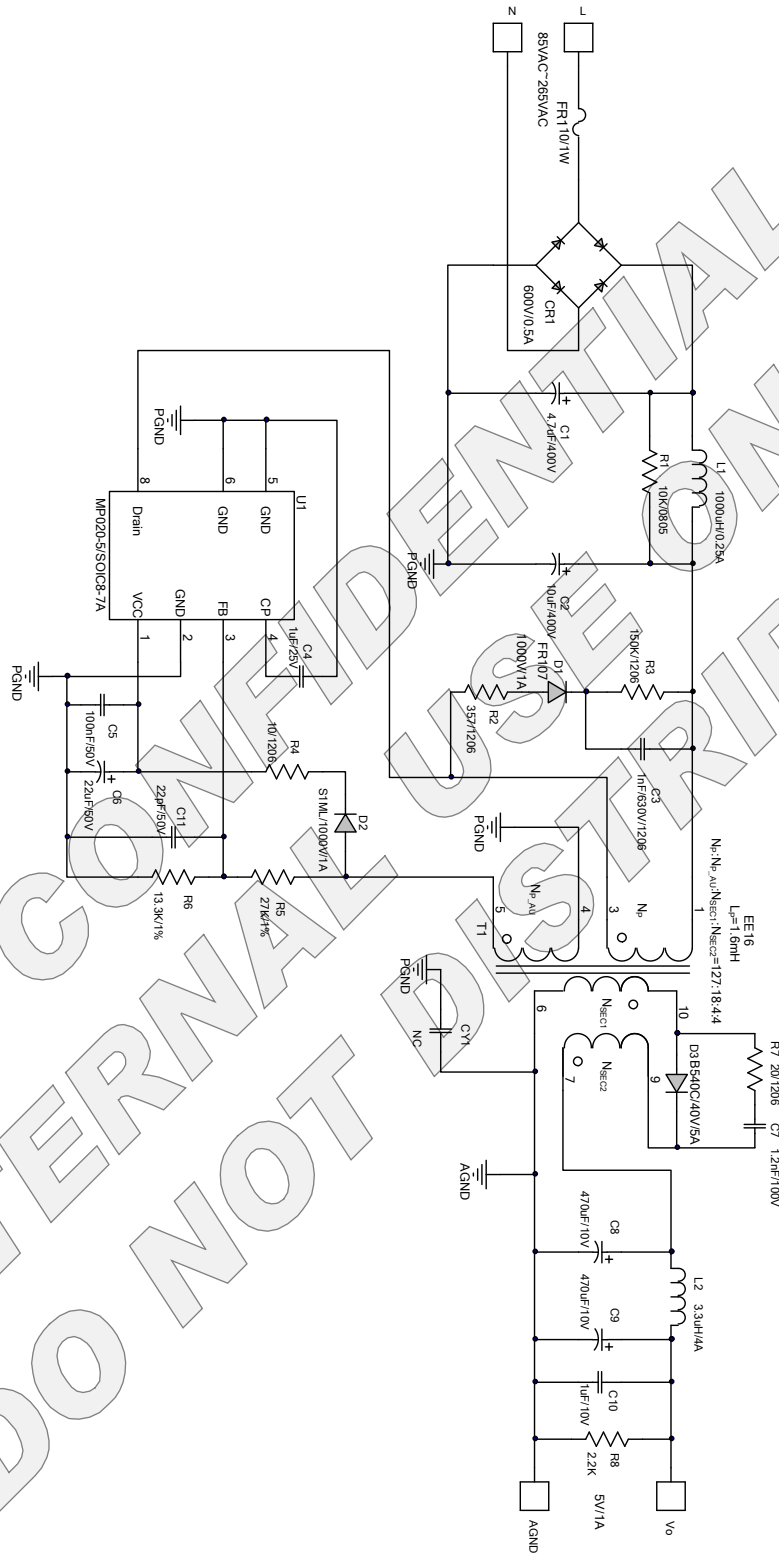

Figure 1—Schematic

PCB LAYOUT (SINGLE-SIDED)

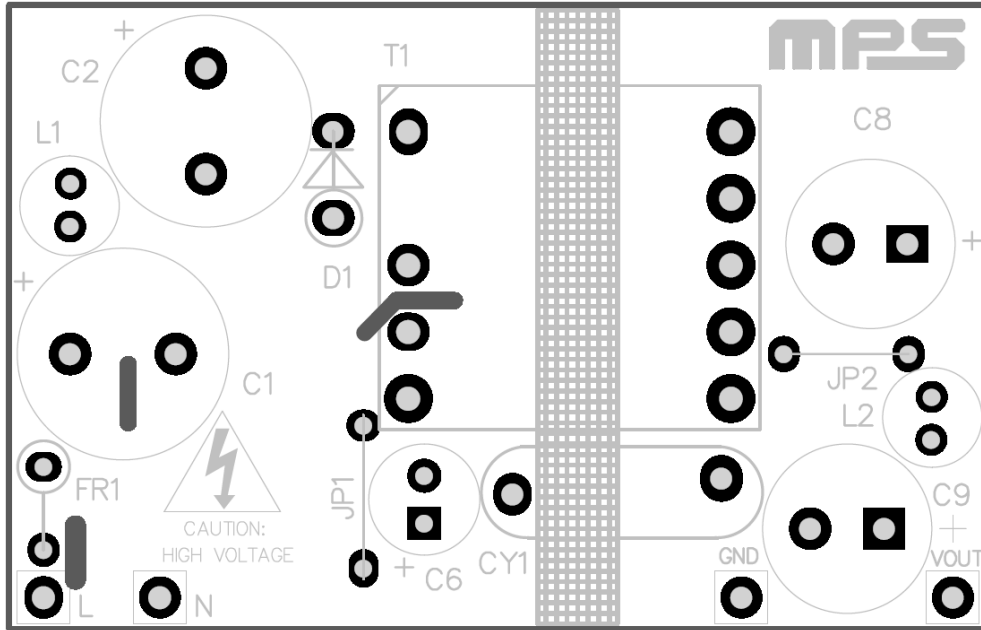

Figure 2—Top Layer

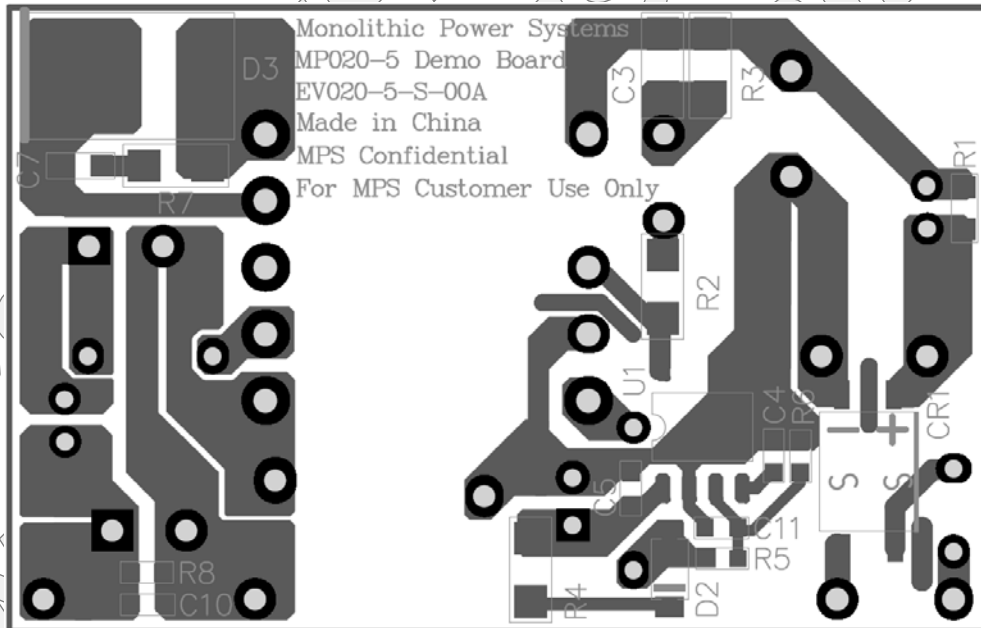

Figure 3—Bottom Layer

CIRCUIT DESCRIPTION

The EV020-5-S-00A is configured in a single-stage Flyback topology, it uses primary-side-control which can mostly simplify the schematic and get a cost effective BOM. It can also achieve accurate constant voltage and constant current.

FR1 and CR1 compose the input stage. FR1 is used to protect for the component failure or some excessive short events, also it can restrain the inrush current.

C1, L1 and C2 compose π filter to guarantee the conducted EMI meet standard EN55022. R2, R3, D1 and C3 compose the snubber circuit to reduce drain-source voltage spike.

R4, C5, C6 and D2 are used as Vcc power supply.

R5 and R6 are resistor divider for detecting output voltage by sampling voltage on primary auxiliary winding.

CY1 is Y capacitor lowering common mode noise to make sure there is enough EMI margin. T1 is power transformer, the structure of which is also very important to pass EMI test.

D3, C8, C9, C10, L2 and R8 compose output circuit. D3 is schottky diode for better efficiency. C10 is ceramic capacitor for lower output voltage ripple and R8 is dummy load, which is used for good regulation. C8, L2 and C9 compose π filter to restrain the output ripple.

R7 and C7 are used to depress the spike of schottky.

EV020-5-S-00A BILL OF MATERIALS

| Qty | Ref | Value | Description | Package | Manufacturer | Manufacturer_P/N |
|---------------|-------|--|--|----------|----------------------|--------------------|
| 1 | C1 | 4.7 μ F | Capacitor;400V;20% | DIP | Nichicon | UVY2G4R7MPD |
| 1 | C2 | 10 μ F | Capacitor;400V;20% | DIP | Ltec | TY 10uF/400V |
| 1 | C3 | 1nF | Ceramic Capacitor;630V;X7R | 1206 | Murata | GRM31A7U2J102JW31D |
| 1 | C4 | 1 μ F | Ceramic Capacitor;25V;X7R; | 0603 | Murata | GRM188R71E105KA12D |
| 1 | C5 | 100nF | Ceramic Capacitor;50V;X7R; | 0603 | Murata | GCJ188R71H104KA12D |
| 1 | C6 | 22 μ F | Electrolytic Capacitor;50V | DIP | Jianghai | CD281L-50V22 |
| 1 | C7 | 1.2nF | Ceramic Capacitor;100V;X7R | 0603 | muRata | GRM188R72A122KA01D |
| 2 | C8,C9 | 470 μ F | Electrolytic Capacitor;10V,Low ESR | DIP | Nippon Chemi-con | EKZE100ELL471MHB5D |
| 1 | C10 | 1 μ F | Ceramic Capacitor;10V;X7R | 0603 | Murata | GRM188R71A105KA61D |
| 1 | C11 | 22pF | Ceramic Capacitor;50V;C0G; | 0603 | Murata | GRM1885C1H220JA01D |
| 1 | CY1 | NC | | | | |
| 1 | CR1 | MB6F | Diode;600V;0.5A | SOP-4 | Diodes | MB6F |
| 1 | D1 | FR107 | Diode;1000V;1A | DO-41 | Diodes | FR107 |
| 1 | D2 | S1ML | Diode;1000V;1A; | SMA | Taiwan Semiconductor | S1ML |
| 1 | D3 | B540C | Schottky Diode;40V;5A | SMC | Diodes | B540C |
| 1 | FR1 | 10 Ω | Fusible Resistor, 1 W, 5% | Yageo | DIP | FKN1WSJT-52-10R |
| 1 | L1 | 1000 μ H | Inductor;1000uH;6 Ohm;0.25A | DIP | Würth | 7447462102 |
| 1 | L2 | 3.3 μ H | Inductor;3.3uH;0.025Ohm;4A | DIP | Würth | 7447462033 |
| 1 | R1 | 10k Ω | Film Resistor;5% | 0805 | Yageo | RC0805JR-0710KL |
| 1 | R2 | 357 Ω | Film Resistor; 1%;1/4W | 1206 | Yageo | RC1206FR-07357RL |
| 1 | R3 | 150k Ω | Film Resistor; 1%;1/4W | 1206 | Panasonic | ERJ8ENF1503V |
| 1 | R4 | 10 Ω | Film Resistor;5%;1/4W | 1206 | Yageo | RC1206JR-0710R |
| 1 | R5 | 27k Ω | Film Resistor;1%; | 0603 | Yageo | RC0603FR-0727KL |
| 1 | R6 | 13.3k Ω | Film Resistor;1% | 0603 | Yageo | RC0603FR-0713K3L |
| 1 | R7 | 20 Ω | Film Resistor;5%;1/4W | 1206 | Royalohm | 1206J0200T5E |
| 1 | R8 | 2.2k Ω | Film Resistor;5%; | 0603 | LIZ | RC0603JA0222G |
| 1 | R9 | 510 Ω | Film Resistor;5%; | 0805 | LIZ | RC0805JA0510 |
| 1 | U1 | | Primary side regulator R3 | SOIC8-7A | MPS | MP020-5GS |
| 1 | T1 | | Transformer;1.6mH; N _P :N _P AU:N _{SEC1} :N _{SEC2} =127:18:4:4 | EE16 | Würth ⁽¹⁾ | 7508110157 |
| Notes: | | (1) Würth transformer sample request please login on website: www.we-online.com | | | | |

TRANSFORMER SPECIFICATION

Electrical Diagram

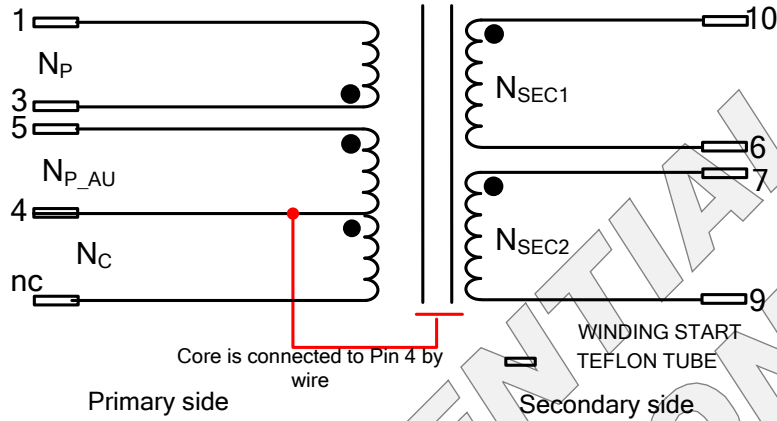

Figure 4—Transformer Electrical Diagram

Notes:

1. N_{SEC1} and N_{SEC2} are coiled at one layer.
2. Core is connected to Pin 4 with naked wire.
3. N_{SEC1} and N_{SEC2} are with Triple Insulation Wire.

Winding Diagram

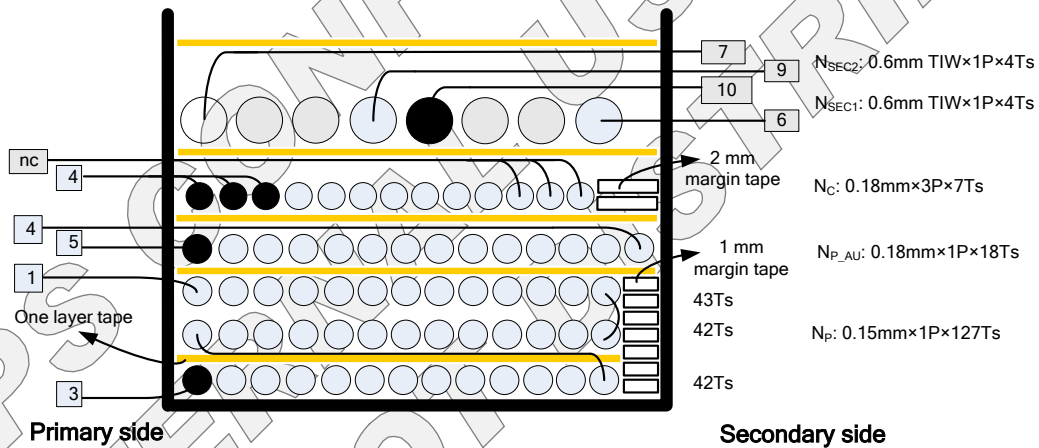

Figure 5—Winding Diagram

Winding Order

| Winding No. | Tape Layer Number | Start & End | Magnet Wire Φ (mm) | Turns |
|-------------------|-------------------|-------------|-------------------------|-------|
| N _P | 1 | 3→1 | 0.15mm * 1 | 127 |
| N _{P_AU} | 1 | 5→4 | 0.18mm * 1 | 18 |
| N _C | 1 | 4→nc | 0.18mm * 3 | 7 |
| N _{SEC1} | 1 | 10→6 | 0.6mm * 1 TIW | 4 |
| N _{SEC2} | 1 | 7→9 | 0.6mm * 1 TIW | 4 |

Electrical Specifications

| | | |
|-----------------------------------|---|-----------|
| Electrical Strength | 60 second, 60Hz, from PRI. to SEC. | 3000VAC |
| | 60 second, 60Hz, from PRI. to CORE. | 500VAC |
| | 60 second, 60Hz, from SEC. to CORE. | 3000VAC |
| Primary Inductance | Pins 1 - 3, all other windings open, measured at 60kHz, 0.1 VRMS | 1.6mH±10% |
| Primary Leakage Inductance | Pins 1 - 3 with all other pins shorted, measured at 60kHz, 0.1 VRMS | 50µH±10% |

Materials

| Item | Description |
|------|--|
| 1 | Core: EE16, U _I =2300±25%, A _L ≤73.2, 4nH/N ² ±3% GAPPED, or equivalent |
| 2 | Bobbin: EE16, 5+5PIN 1 SECT TH, UL94V-0 |
| 3 | Wire: Φ 0.15mm, 2UEW, Class B |
| 4 | Wire: Φ 0.18mm, 2UEW, Class B |
| 5 | Triple Insulation Wire: Φ 0.60mm TIW |
| 6 | Tape: 8.0mm(W)×0.06mm(TH) |
| 7 | Varnish: JOHN C. DOLPH CO, BC-346A or equivalent |
| 8 | Solder Bar: CHEN NAN: SN99.5/Cu0.5 or equivalent |

EVB TEST RESULTS

Performance Data

$T_A=25^\circ\text{C}$, unless otherwise noted.

Efficiency

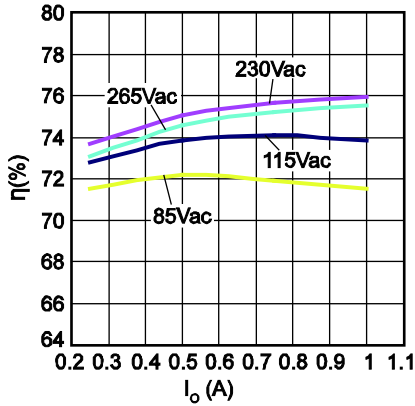

No Load Consumption

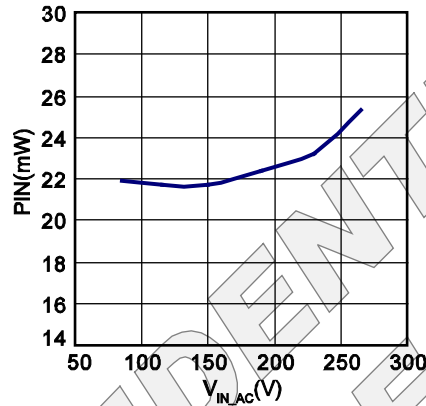

Line Regulation

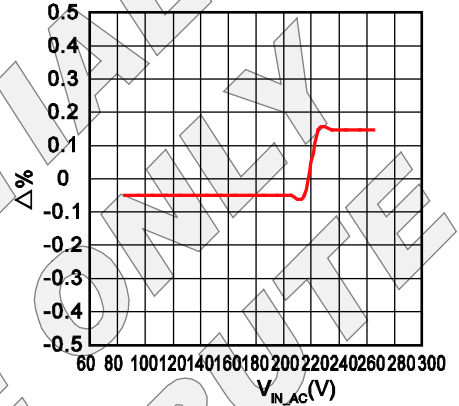

CV/CC

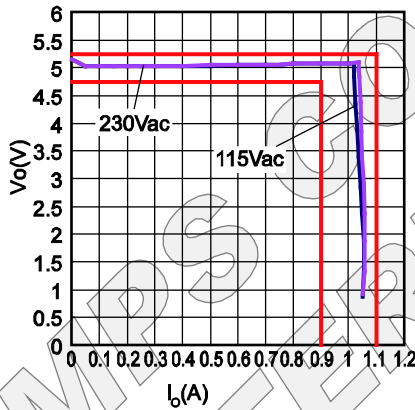

Electric Strength Test

Primary circuit to secondary circuit electric strength testing was completed according to IEC61000-4-2.

Input and output was shorted respectively. 3000VAC/50Hz sine wave applied between input and output for 1min, and operation was verified.

Surge Test

Line to Line 1kV and Line to Power Earth 1kV surge testing was completed according to IEC61000-4-5. Input voltage was set at 220VAC/50Hz. Output was loaded at full load and operation was verified following each surge event.

| Surge Level (V) | Input Voltage (VAC) | Injection Location | Injection Phase (°) | Test Result (Pass/Fail) |
|-----------------|---------------------|--------------------|---------------------|-------------------------|
| 1000 | 220 | L to N | 90 | Pass |
| -1000 | 220 | L to N | 270 | Pass |
| 1000 | 220 | L to PE | 90 | Pass |
| -1000 | 220 | L to PE | 270 | Pass |
| 1000 | 220 | N to PE | 90 | Pass |
| -1000 | 220 | N to PE | 270 | Pass |

MPS CONFIDENTIAL
INTERNAL USE ONLY
DO NOT DISTRIBUTE

Conducted EMI Test

Test with 230Vac input and full load condition

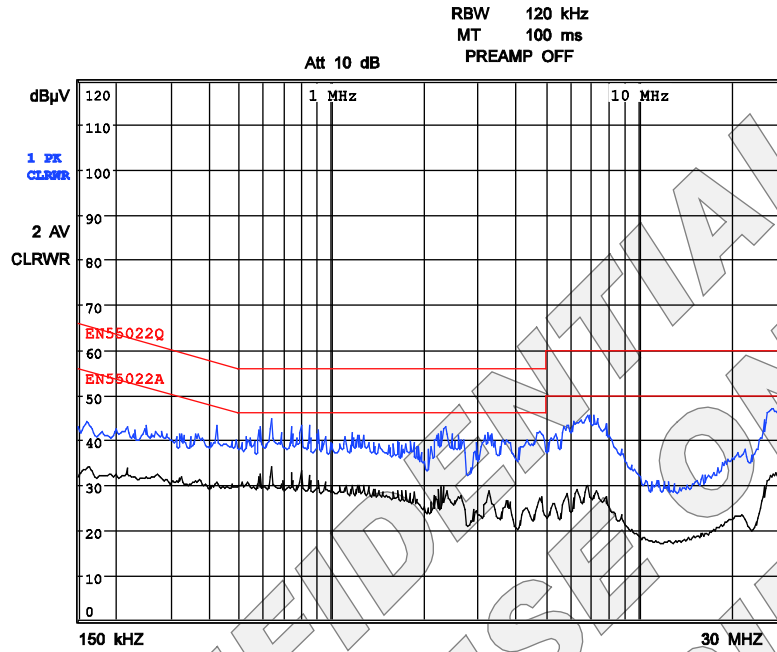

230Vac, 50Hz, Maximum Load, L Line, Output GND floats, EN55022 Limits

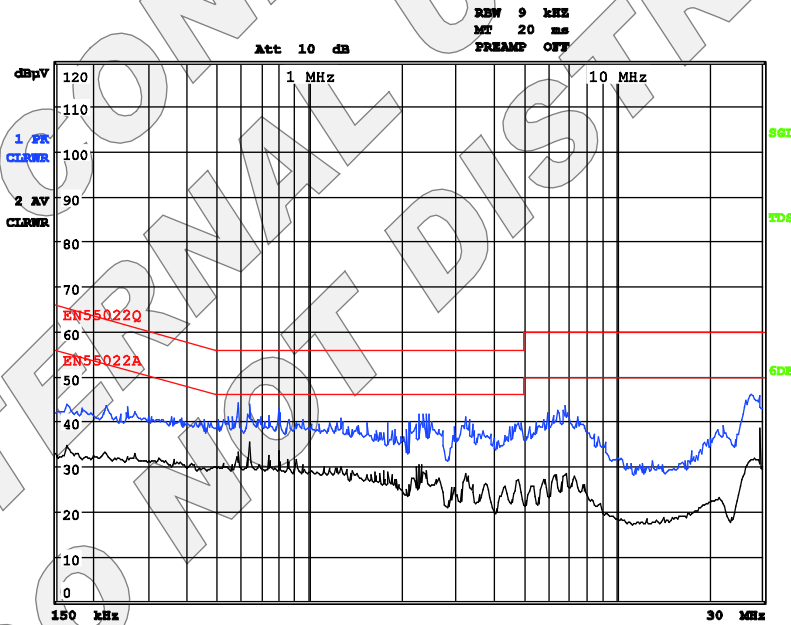

230Vac, 50Hz, Maximum Load, N Line, Output GND floats, EN55022 Limits

Conducted EMI Test (*continued*)

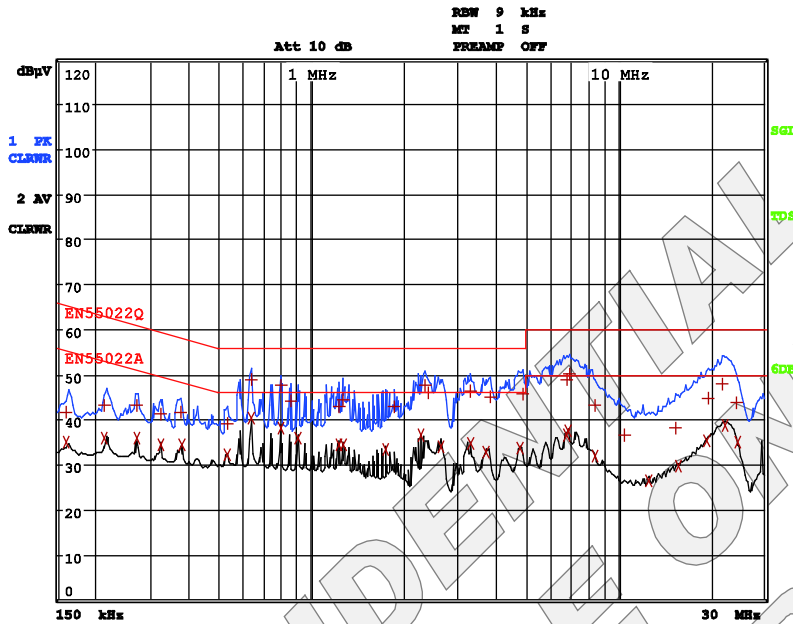

230Vac, 50Hz, Maximum Load, L Line, Output GND connects to Earth, EN55022 Limits

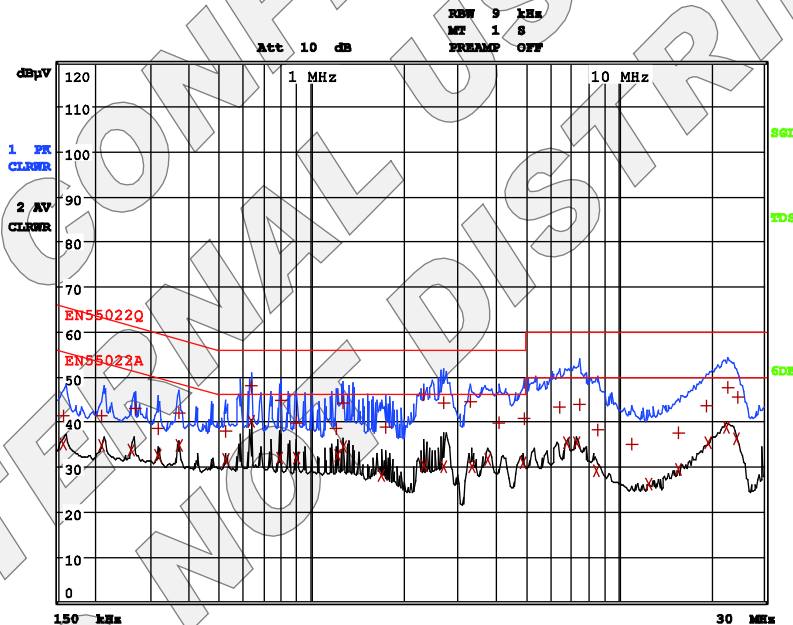

230Vac, 50Hz, Maximum Load, N Line, Output GND connects to Earth, EN55022 Limits

Thermal Test

Test with 85Vac input and full load condition. PCB layout is with 1Oz copper. Ambient temperature is 25°C.

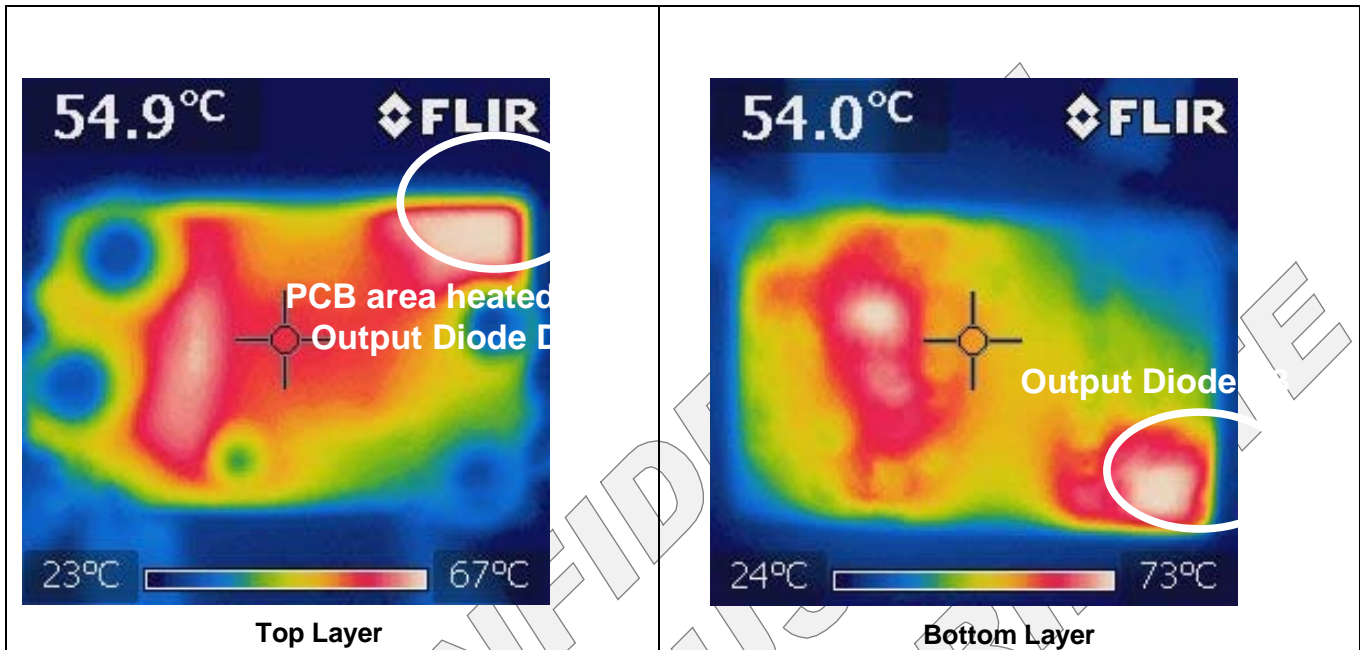

EVB TEST RESULTS

Performance waveforms are tested on the evaluation board.

$V_{IN}=115VAC/60Hz$, $V_{OUT}=5V$, $I_{OUT}=1A$, $L_P=1.6mH$, $N_P:N_{P_AU}:N_{SEC1}:N_{SEC2}=127:18:4:4$, $T_A=25^\circ C$, unless otherwise noted.

Steady State

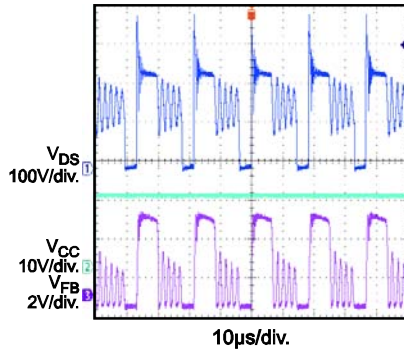

Turn On Delay

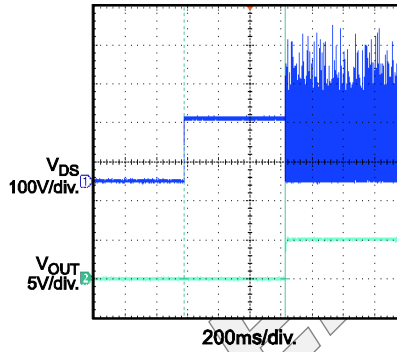

Output Rise Time

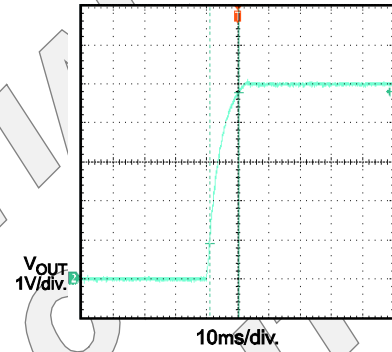

Output Ripple

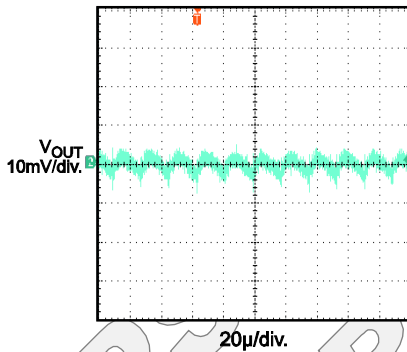

SCP Enter

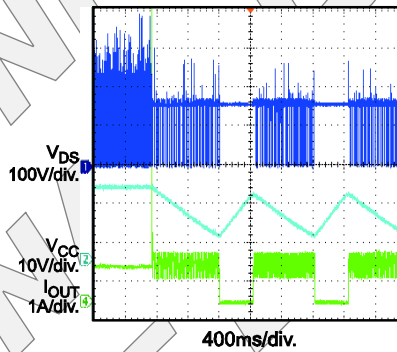

SCP Recovery

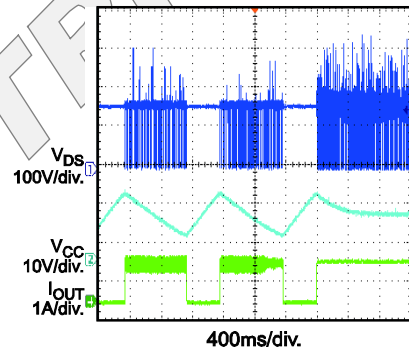

OckP Enter

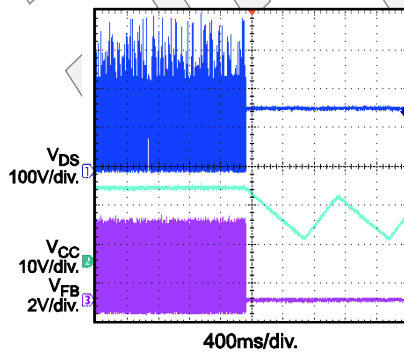

OckP Recovery

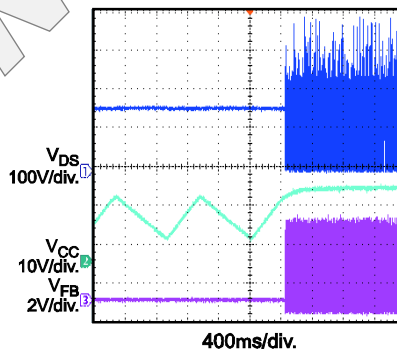

Load Transient

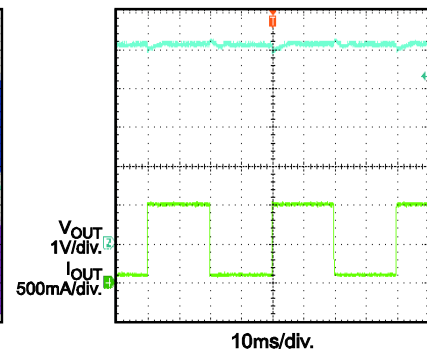

EVB TEST RESULTS *(continued)*

Performance waveforms are tested on the evaluation board.

 $V_{IN}=230VAC/50Hz$, $V_{OUT}=5V$, $I_{OUT}=1A$, $L_P=1.6mH$, $N_P:N_{P_AU}:N_{SEC1}:N_{SEC2}=127:18:4:4$, $T_A=25^\circ C$, unless otherwise noted.

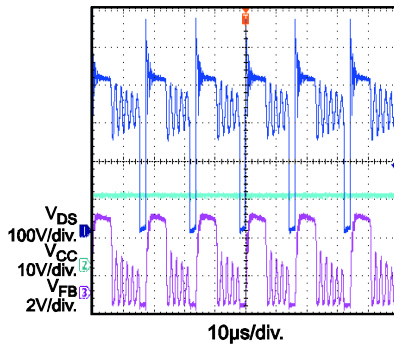
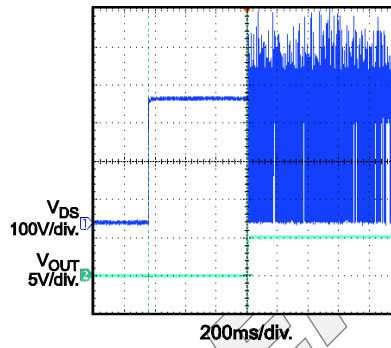
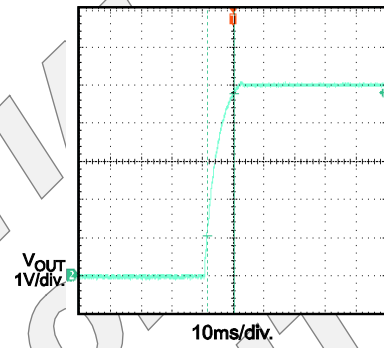
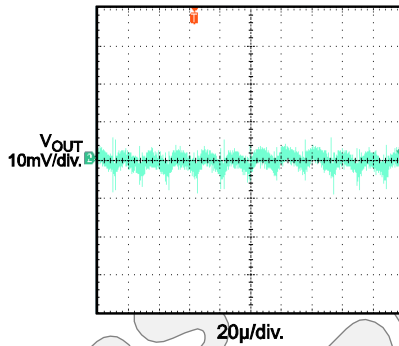
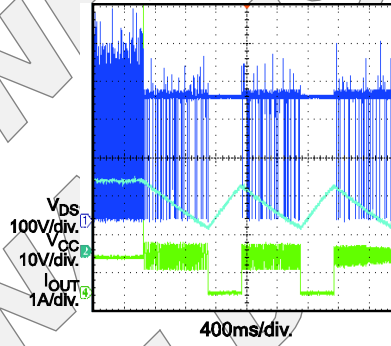
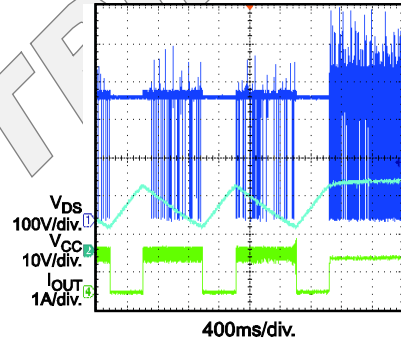
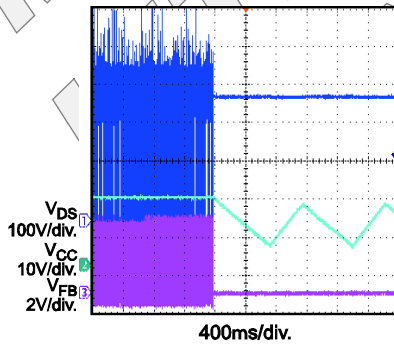
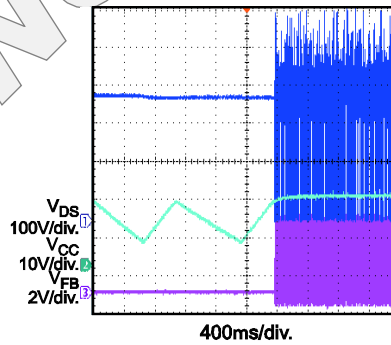
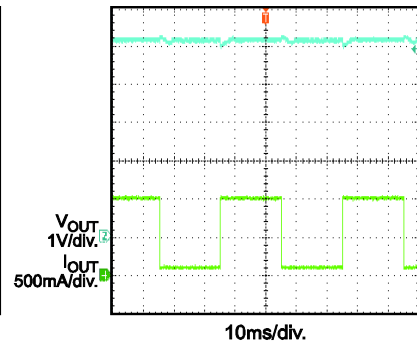
Steady State

Turn On Delay

Output Rise Time

Output Ripple

SCP Enter

SCP Recovery

OCP Enter

OCP Recovery

Load Transient

QUICK START GUIDE

1. Preset Power Supply to $85\text{VAC} \leq V_{\text{IN}} \leq 265\text{VAC}$.
2. Turn Power Supply off.
3. Connect the Line and Neutral terminals of the power supply output to L and N port. For three-wire input application, make OUTPUT GND connected to Earth.
4. Connect Load to:
 - a. Positive (+): VOUT
 - b. Negative (-): GND
5. Turn Power Supply on after making connections.

Contact Information

To request this evaluation board, please refer to your local sales offices which can be found from:

<http://www.monolithicpower.com/Company/Contact-Us>

Disclaimer

Monolithic Power Systems (MPS) reserves the right to make changes to its products and to discontinue products without notice. The applications information, schematic diagrams, and other reference information included herein is provided as a design aid only and are therefore provided as-is. MPS makes no warranties with respect to this information and disclaims any implied warranties of merchantability or non-infringement of third-party intellectual property rights.

MPS cannot assume responsibility for use of any circuitry other than circuitry entirely embodied in a MPS product. No circuit patent licenses are implied.

Certain applications using semiconductor products may involve potential risks of death, personal injury, or severe property or environmental damage ("Critical Applications").

MPS PRODUCTS ARE NOT DESIGNED, INTENDED, AUTHORIZED, OR WARRANTED TO BE SUITABLE FOR USE IN LIFE-SUPPORT APPLICATIONS, DEVICES OR SYSTEMS, OR OTHER CRITICAL APPLICATIONS.

Inclusion of MPS products in critical applications is understood to be fully at the risk of the customer. Questions concerning potential risk applications should be directed to MPS.

MPS semiconductors are typically used in power supplies in which high voltages are present during operation. High voltage safety precautions should be observed in design and operation to minimize the chance of injury.

NOTICE: The information in this document is subject to change without notice. Please contact MPS for current specifications. Users should warrant and guarantee that third party Intellectual Property rights are not infringed upon when integrating MPS products into any application. MPS will not assume any legal responsibility for any said applications.