

## Evaluation Board Report

### 5.9W ACDC power supply with Dual Output

Design Specs	Value	Unit
Input Voltage	85-265	VAC
Output1	18V, 0.3A	
Output2	5V, 0.1A	
Isolation	No	
MPS IC	MP157GJ	
Application	Small Appliances ACDC Power Supply with additional 5V output	

Document Number	EBXXX
Author	Application Engineering Department
Date	Nov, 2014
Revision	1.0

### Design Summary

EV157-J-00A evaluation board provides a reference design for a universal offline power supply with dual outputs, one with 18V,0.3A and the other 5V,0.1A. It contains the complete specification of the power supply, a detailed circuit diagram, the entire bill of materials required to build the power supply, drawing of the power inductors and transformers, and test data of the most important performance.

## DESCRIPTION

The EV157-J-00B Evaluation Board is designed to demonstrate the dual output capabilities of MP157. The MP157 is a primary-side constant voltage regulator.

The EV157-J-00B is typically designed for small appliances which output 18V/0.3A and 5V/0.1A load from 85VAC to 265VAC, 50HZ/60HZ.

The EV157-J-00B has an excellent efficiency and meets IEC61000-4-5 surge immunity and EN55022 conducted EMI requirements. It has multi-protection function as open circuit protection, over load protection, short-circuit protection, and over-temperature protection, etc.

## ELECTRICAL SPECIFICATION

Parameter	Symbol	Value	Units
Input Voltage	$V_{IN}$	85 to 265	VAC
Output Voltage 1	$V_{OUT1}$	18	V
Output Current 1	$I_{OUT1}$	0.3	A
Output Voltage 2	$V_{OUT2}$	5	V
Output Current 2	$I_{OUT2}$	0.1	A
Output Power	$P_{OUT}$	5.9	W
Efficiency (full load)	$\eta$	>70	%

## FEATURES

- Primary-Side non-isolated Constant Voltage Control (CV)
- Integrated 500V MOSFET with Minimal External Components
- Peak-Current Control with Peak Current Compression
- Limited Maximum Frequency and Frequency Foldback,
- Multiple Protections: SCP, OCP, OTP, and VCC UVLO
- Low Cost and Simple External circuit

All MPS parts are lead-free and adhere to the RoHS directive. For MPS green status, please visit MPS website under Quality Assurance. "MPS" and "The Future of Analog IC Technology", are Registered/Trademarks of Monolithic Power Systems, Inc.



**Warning:** Although this board is designed to satisfy safety requirements, the engineering prototype has not been agency approved. Therefore, all testing should be performed using an isolation transformer to provide the AC input to the prototype board.

EV157-J-00B EVALUATION BOARD



TOP VIEW



BOTTOM VIEW

(L x W x H) 68mm x 28mm x 17mm

Board Number	MPS IC Number
EV157-J-00B	MP157GJ

EVALUATION BOARD SCHEMATIC

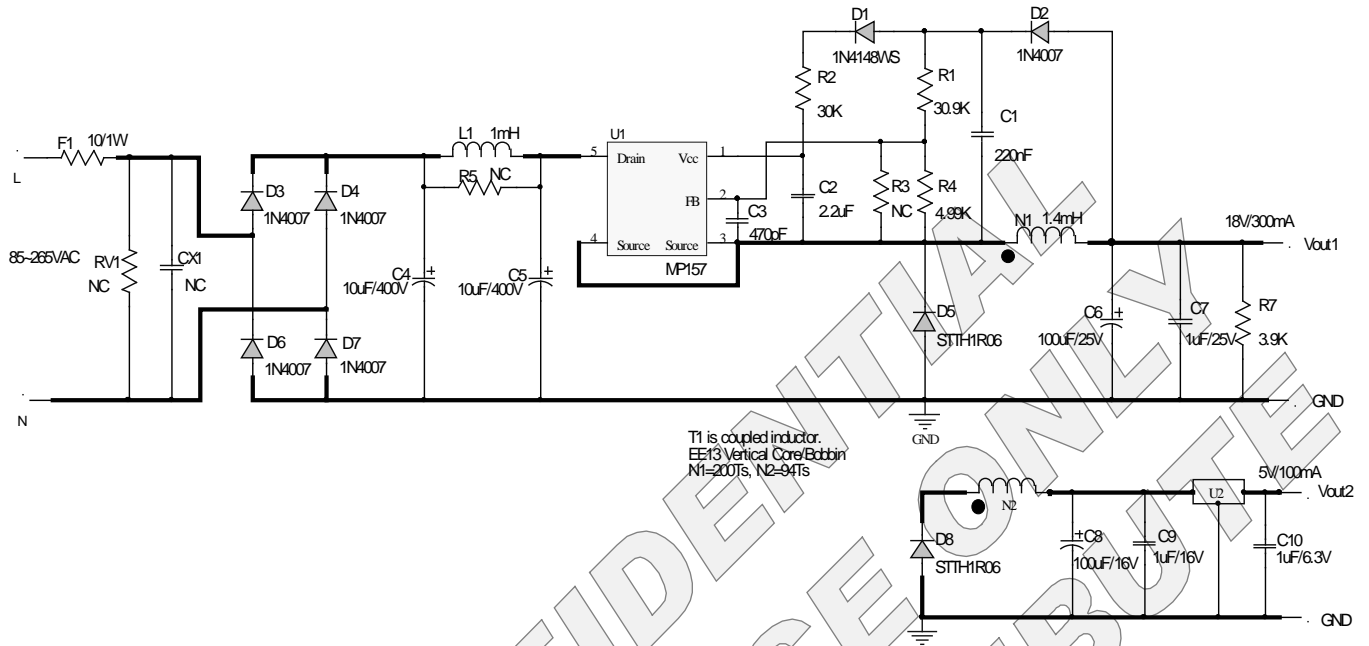

Figure 1—Schematic

PCB LAYOUT (SINGLE-SIDED)

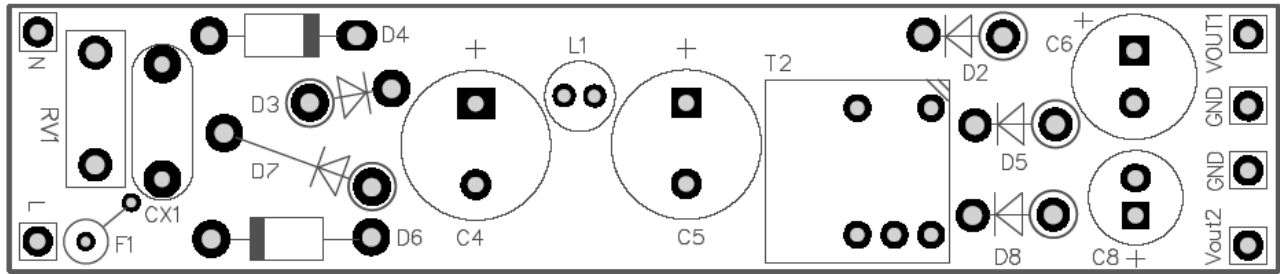

Figure 2—Top Layer

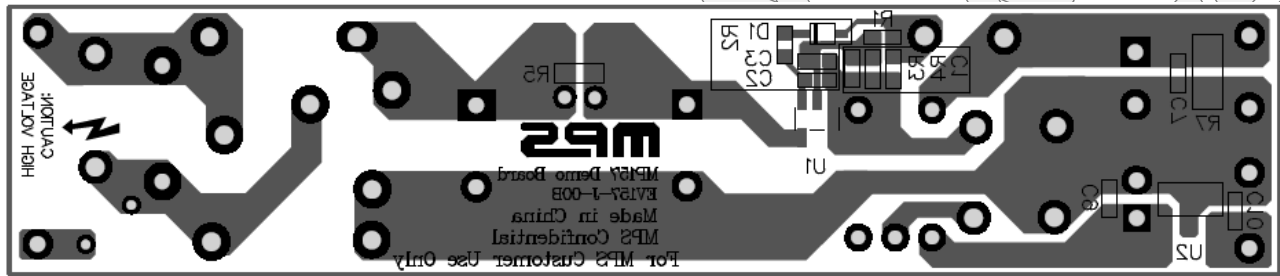

Figure 3—Bottom Layer

## CIRCUIT DESCRIPTION

The EV157-J-00B is configured in a buck regulator topology, it uses primary-side-control which can mostly simplify the schematic and get a cost effective BOM. It can also achieve accurate constant voltage and acceptable cross regulation.

F1 is used to protect circuit from component failure or some excessive short events; also it can restrain the inrush current.

C4, L1 and C5 compose  $\pi$  filter to guarantee the conducted EMI meet standard EN55022.

R2, C2, and D1 are used as VCC power supply. Though MP157 is equipped with an internal high voltage current source, using this circuit can achieve better efficiency.

C1 is the sample-hold capacitor, used for reflecting output voltage. R1 and R4 are resistor divider for detecting output voltage by sampling voltage on C1.

T1 is power transformer; it has two coupling windings to achieve dual output.

D5 is freewheeling diode for 18V output. Select a diode with a maximum reverse block voltage rating that exceeds the maximum input voltage. For universal voltage applications, use a diode with a 600V reverse block voltage. Ultra-fast recovery diode is recommended for better efficiency.

C6 and C7 are output capacitors for 18V output. C6 should be low ESR electrolytic capacitor for better output ripple. C7 is ceramic capacitor to reduce high frequency voltage ripple. R7 is dummy load to lower the output voltage of 18V rail at no load condition.

D8 is freewheeling diode for 5V output. Simply select a diode same as D5.

C8 and C9 are output capacitors for 5V output. C8 should be low ESR electrolytic capacitor for better load regulation. C9 is ceramic capacitor to reduce high frequency voltage ripple.

U2 is three terminals voltage regulator for precise 5V output. C10 is output capacitor for U3.



**EV157-J-00B BILL OF MATERIALS**

Qty	Ref	Value	Description	Package	Manufacturer	Manufacturer_P/N
1	CX1	NC	No Connected			
1	C1	220nF	Ceramic Capacitor; 25V;X5R	0603	Murata	GRM188R71E224KA01D
1	C2	2.2 $\mu$ F	Ceramic Capacitor; 10V;X7R	0603	Murata	GRM188R71A225KE15D
1	C3	470pF	Ceramic Capacitor; 50V;C0G	0603	Murata	GRM1885C1H471JA01D
2	C4, C5	10 $\mu$ F/400V	Electrolytic Capacitor; 400V	DIP	Ltec	TY Series, 10uF/400V
1	L1	1mH	Inductor;1mH; 6Ohm;0.25A	DIP	Würth	7447462102
1	C6	100 $\mu$ F	Electrolytic Capacitor;25V	DIP	Rubycon	25YXF100M6.3X11
1	C7	1 $\mu$ F	Ceramic Capacitor; 25V;X7R	0603	TDK	C2012X7R1E105K
1	C8	100 $\mu$ F	Electrolytic Capacitor;16V	DIP	江海	CD11C-16V100
1	C9	1 $\mu$ F	Ceramic Capacitor; 16V;X7R	0603	TDK	C1608X7R1C105K
1	C10	1 $\mu$ F	Ceramic Capacitor; 6.3V;X5R	0603	Murata	GRM188R60J105KA01D
1	D1	1N4148WS	Diode;75V;0.15A	SOD323	Diodes	1N4148WS-7-F
5	D2, D3, D4, D6, D7	1N4007	Diode;1000V;1A	DO-41	Diodes	1N4007
2	D5, D8	STTH1R06	Diode;600V;1A	DO-41	ST	STTH1R06
1	F1	10 $\Omega$	Fuse Resistor;5%;1W	DIP	Yageo	FKN1WSJT-52-10N
1	R1	30.9k $\Omega$	Film Resistor;1%	0603	Yageo	RC0603FR-0730K9L
1	R2	30k $\Omega$	Film Resistor;1%	0603	Yageo	RC0603FR-0730KL
1	R3	NC	No Connected			
1	R4	4.99k $\Omega$	Film Resistor;1%	0603	Yageo	RC0603FR-074K99L
1	R5	NC	No Connected			
1	R7	3.9k	Film Resistor;1%	1206	Yageo	RC1206FR-073K9L
1	RV1	NC	No Connected			
1	T1	1.4mH	N1:N2=200:94	EE13	Würth	750342025
					Emei	FX0336
1	U1	MP157	Buck regulator	TSOT23-5	MPS	MP157GJ
1	U2	L78L05ACUTR	LDO, 5V, 100mA	SOT89	ANY	
6	L, N, Vout1, GND, Vout2 GND		Connector, 1mm			
Notes:		(1) Würth transformer sample request please log on website: <a href="http://www.we-online.com">www.we-online.com</a> (2) Emei transformer sample request please log on website: <a href="http://www.emeigroup.com">www.emeigroup.com</a>				

## TRANSFORMER SPECIFICATION

### Electrical Diagram

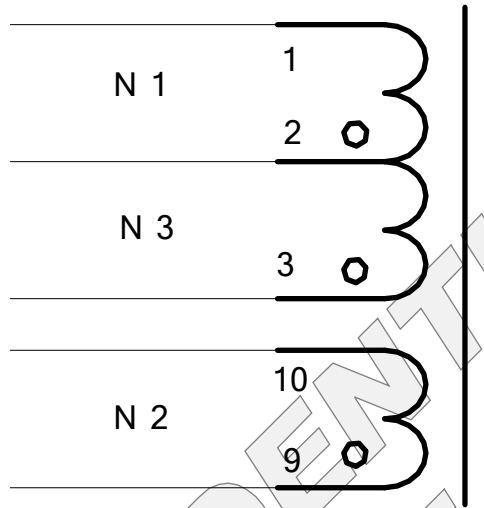

Figure 4—Transformer Electrical Diagram

**Notes:**

1. Remove pin2, 4, 5, 6, 7, 8.
2. One layer tape is between each layer winding. 1 layers tape is at the outside of last winding

### Winding Diagram

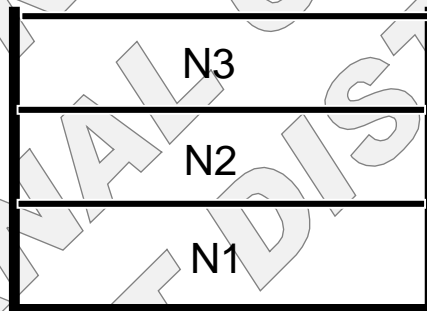

Figure 5—Winding Diagram

### Winding Order

Tapes (T)	Winding	Start-End	Wire Diameter (Ø)	Turns ( T )	Tube
0					
1	N1	3 → 2	0.23*1	106	None
1	N2	9 → 10	0.15*1	94	None
1	N3	2 → 1	0.23*1	94	None



**Electrical Specifications**

<b>Electrical Strength</b>	60 seconds 60Hz, from PRI. to SEC.	500VAC
	60 seconds 60Hz, from PRI. to CORE.	500VAC
	60 seconds 60Hz, from SEC. to CORE.	500VAC
<b>Primary Inductance</b>	Pins 1 - 3, all other windings open, measured at 60kHz, 0.1 VRMS	1.4mH±10%

**Materials**

Item	Description
1	Core: EE13, PC40
2	Bobbin: EE13, 4+4PIN
3	Wire:Φ0.15mm,, 2UEW, Class B
4	Wire:Φ0.23mm,, 2UEW, Class B
6	Tape: 7.5mm(W)×0.06mm(TH)
7	Varnish: JOHN C. DOLPH CO, BC-346A or equivalent
8	Solder Bar: CHEN NAN: SN99.5/Cu0.5 or equivalent

**Surge Test**

Line to Line 1kV surge tested according to IEC61000-4-5.

Input voltage was set at 230VAC/50Hz. Output was loaded at full load and operation was verified following each surge event.

Surge Level (V)	Input Voltage (VAC)	Injection Location	Injection Phase (°)	Test Result (Pass/Fail)
1000	230	L to N	0	Pass
1000	230	L to N	90	Pass
1000	230	L to N	180	Pass
1000	230	L to N	270	Pass
-1000	230	L to N	0	Pass
-1000	230	L to N	90	Pass
-1000	230	L to N	180	Pass
-1000	230	L to N	270	Pass

**Thermal Test**

Test with 115Vac input and full load condition,  $T_a=30^{\circ}\text{C}$

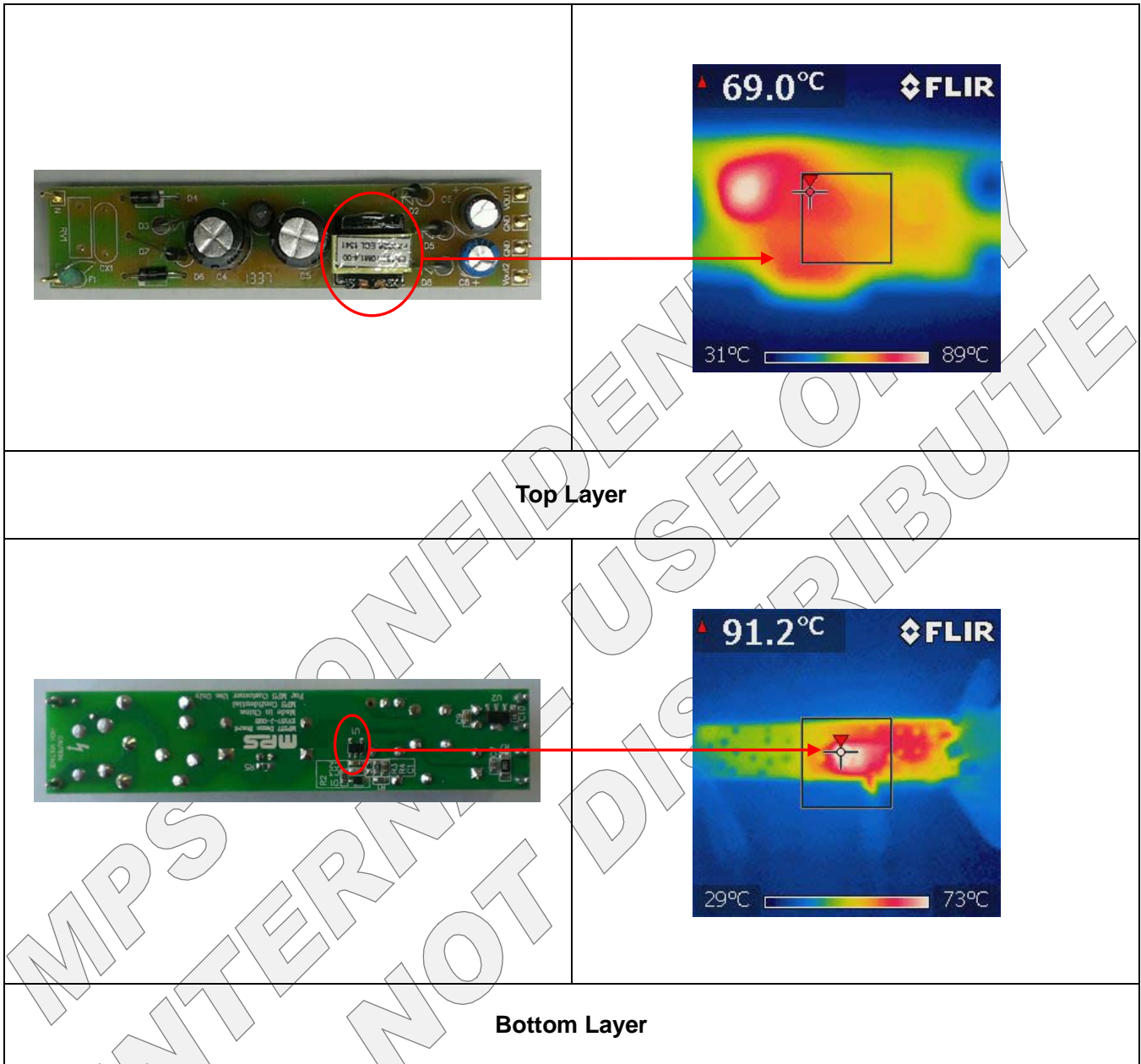

## EVB TEST RESULTS

Performance waveforms are tested on the evaluation board.

$V_{IN}=85-265V_{AC}$ ,  $V_{OUT1}=18V$ ,  $I_{OUT1}=0.3A$ ,  $V_{OUT2}=5V$ ,  $I_{OUT2}=0.1A$ , CC Mode Load,  $T_a=30^{\circ}C$

**Efficiency**

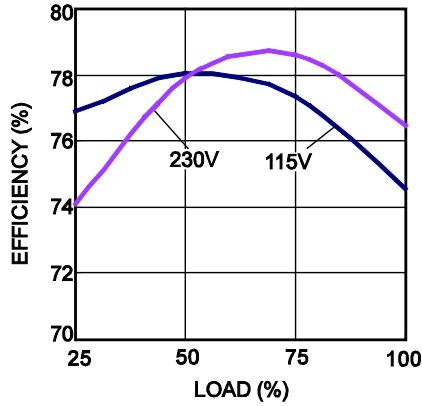

**No Load Consumption**

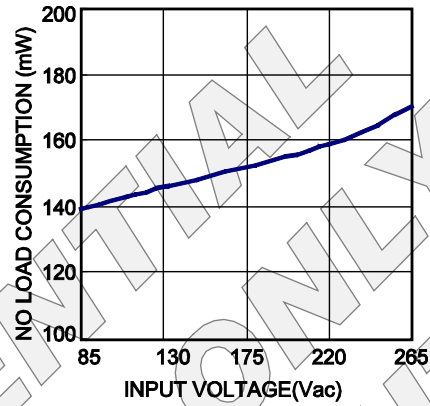

**Steady State**

$V_{IN} = 115V_{AC}$ , Full Load

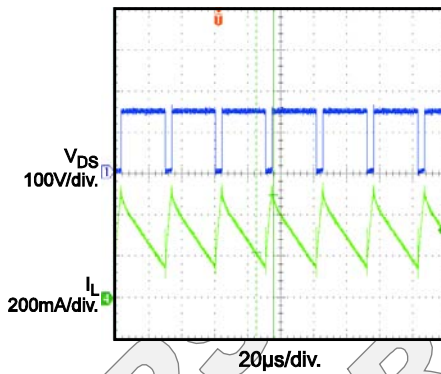

**Steady State**

$V_{IN} = 230V_{AC}$ , Full Load

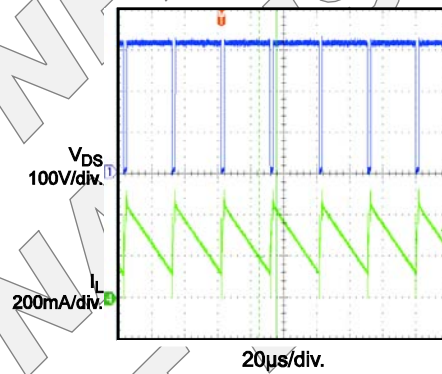

**Output Ripple**

$V_{IN} = 115V_{AC}$ , No Load

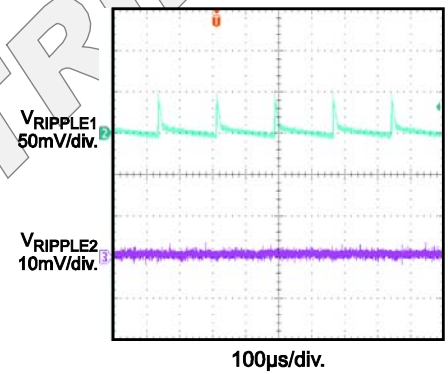

**Output Ripple**

$V_{IN} = 115V_{AC}$ , Full Load

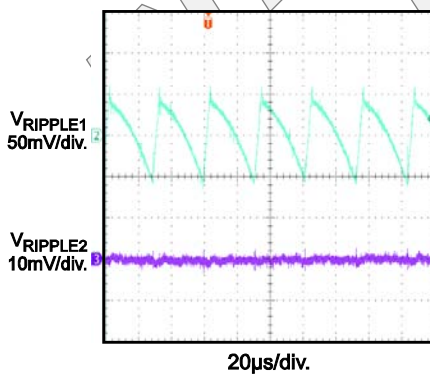

**Output Ripple**

$V_{IN} = 230V_{AC}$ , No Load

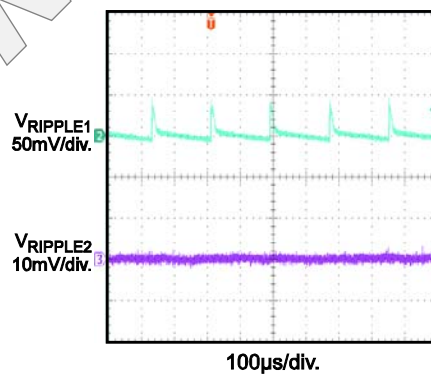

**Output Ripple**

$V_{IN} = 230V_{AC}$ , Full Load

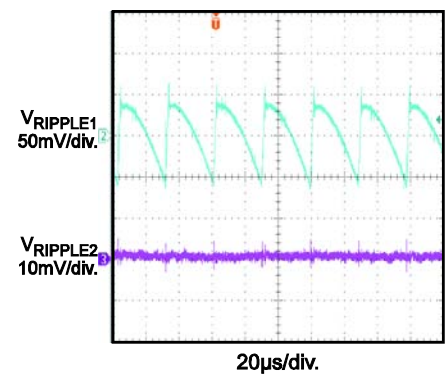

### EVB TEST RESULTS (continued)

Performance waveforms are tested on the evaluation board.

$V_{IN}=85-265V_{AC}$ ,  $V_{OUT1}=18V$ ,  $I_{OUT1}=0.3A$ ,  $V_{OUT2}=5V$ ,  $I_{OUT2}=0.1A$ , CC Mode Load,  $T_a=30^{\circ}C$

#### Soft Start

$V_{IN} = 85V_{AC}$

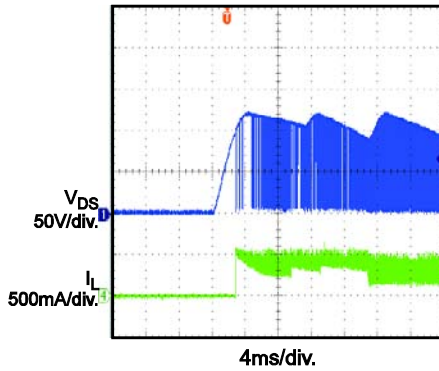

#### Soft Start

$V_{IN} = 265V_{AC}$

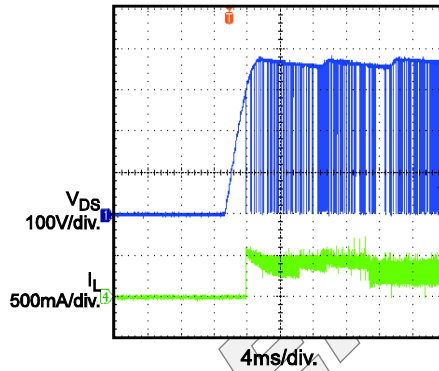

#### Turn-on Delay

$V_{IN} = 115V_{AC}$ , No Load

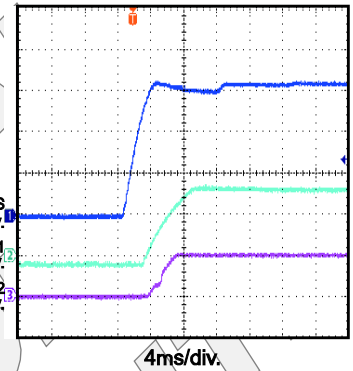

#### Turn-on Delay

$V_{IN} = 115V_{AC}$ , Full Load

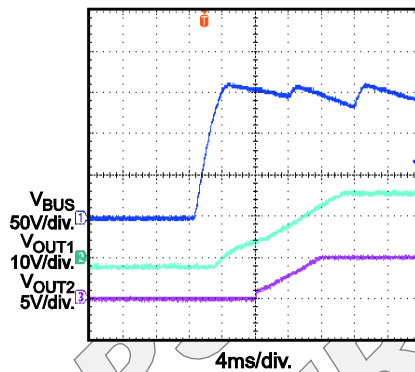

#### Turn-on Delay

$V_{IN} = 230V_{AC}$ , No Load

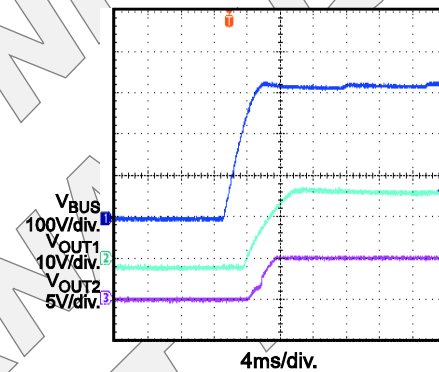

#### Turn-on Delay

$V_{IN} = 230V_{AC}$ , Full Load

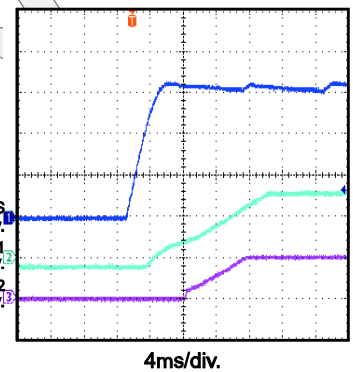

#### Load Transient

$V_{IN} = 115V_{AC}$ ,  
25% Load to 50% Load

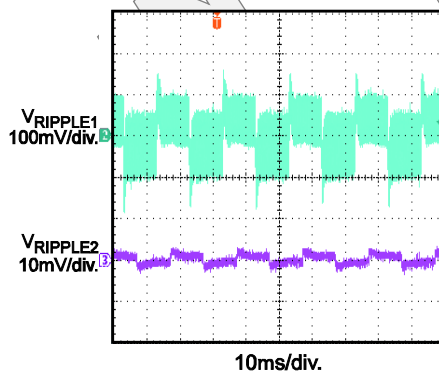

#### Load Transient

$V_{IN} = 115V_{AC}$ ,  
50% Load to 75% Load

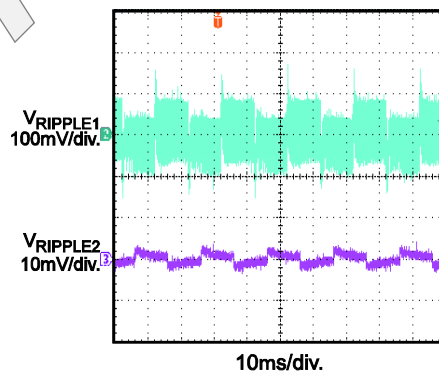

#### Load Transient

$V_{IN} = 230V_{AC}$ ,  
25% Load to 50% Load

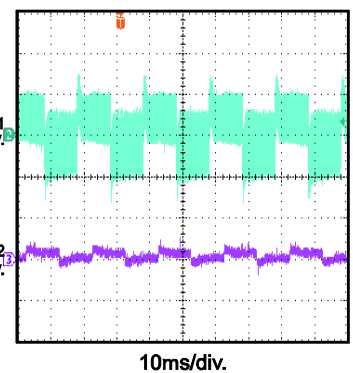

### EVB TEST RESULTS (continued)

Performance waveforms are tested on the evaluation board.

$V_{IN}=85-265VAC$ ,  $V_{OUT1}=18V$ ,  $I_{OUT1}=0.3A$ ,  $V_{OUT2}=5V$ ,  $I_{OUT2}=0.1A$ , CC Mode Load,  $T_a=30^{\circ}C$

#### Load Transient

$V_{IN} = 230VAC$ ,  
50% Load to 75% Load

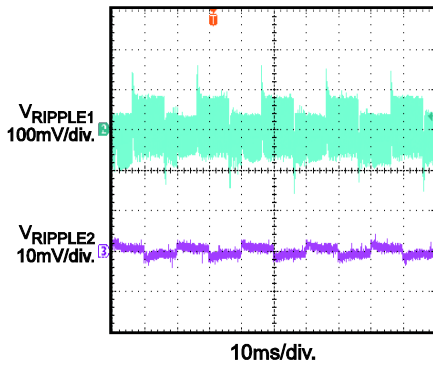

#### OTP

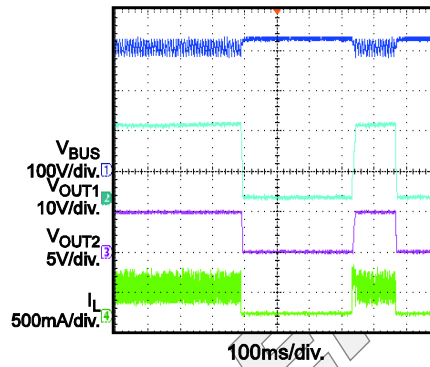

#### SCP

$V_{IN} = 115VAC$

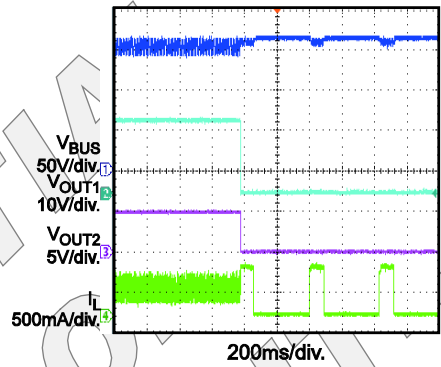

#### SCP

$V_{IN} = 230VAC$

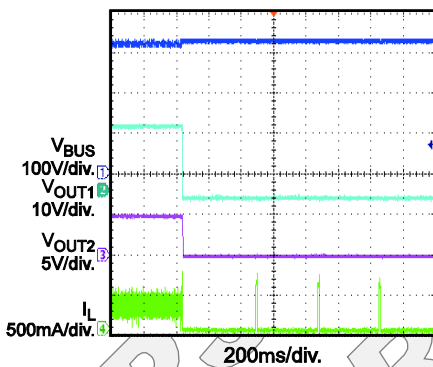

#### Open Loop Protection

$V_{IN} = 115VAC$ , No Load

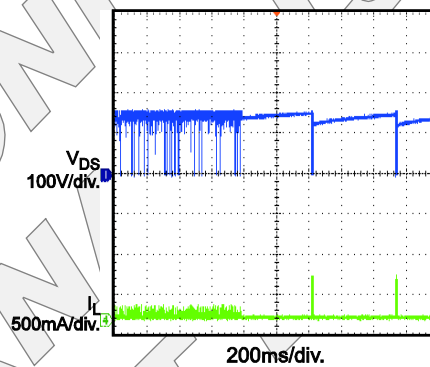

#### Open Loop Protection

$V_{IN} = 115VAC$ , Full Load

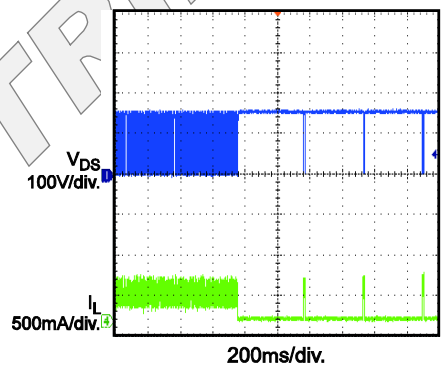

#### Open Loop Protection

$V_{IN} = 230VAC$ , No Load

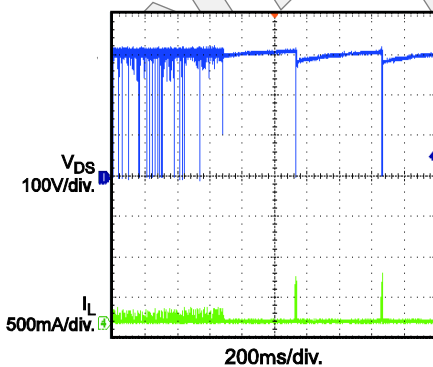

#### Open Loop Protection

$V_{IN} = 230VAC$ , Full Load

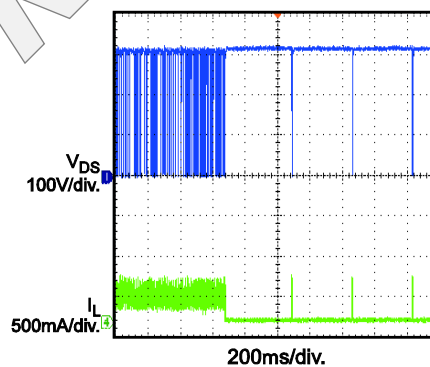

#### Conducted EMI

Two-Wire Input,  $V_{IN} = 115VAC$

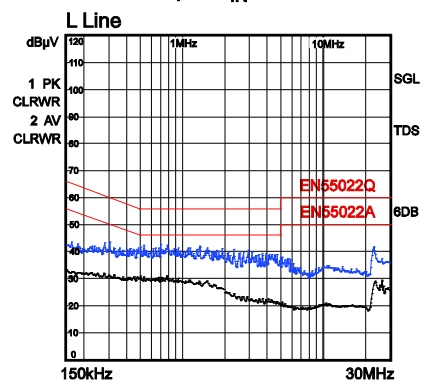



### EVB TEST RESULTS (continued)

Performance waveforms are tested on the evaluation board.

$V_{IN}=85-265VAC$ ,  $V_{OUT1}=18V$ ,  $I_{OUT1}=0.3A$ ,  $V_{OUT2}=5V$ ,  $I_{OUT2}=0.1A$ , CC Mode Load,  $T_a=30^{\circ}C$

#### Conducted EMI

Two-Wire Input,  $V_{IN} = 115VAC$

N Line

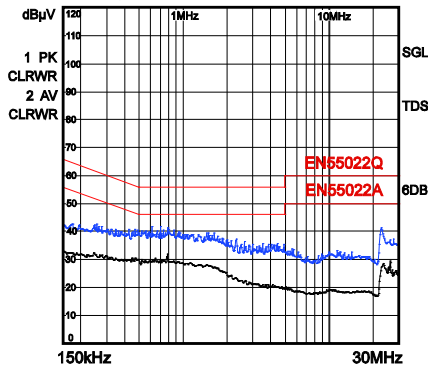

#### Conducted EMI

Two-Wire Input,  $V_{IN} = 230VAC$

L Line

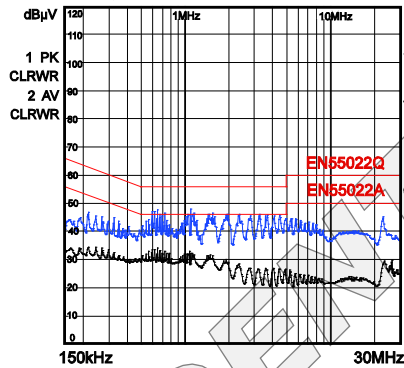

#### Conducted EMI

Two-Wire Input,  $V_{IN} = 230VAC$

N Line

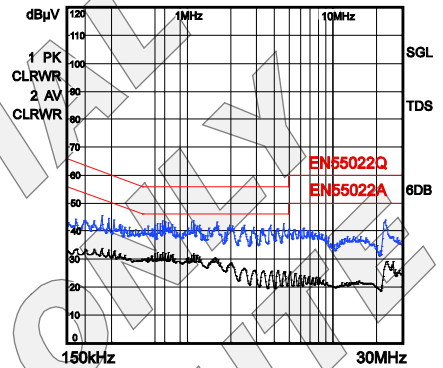

MPS CONFIDENTIAL  
INTERNAL USE ONLY  
DO NOT DISTRIBUTE



## QUICK START GUIDE

1. Preset Power Supply to  $85\text{VAC} \leq V_{\text{IN}} \leq 265\text{VAC}$ .
2. Turn Power Supply off.
3. Connect the Line and Neutral terminals of the power supply output to L and N port. For three-wire input application, make OUTPUT GND connected to Earth.
4. Connect Different Load to Corresponding Outputs :
  - a. Positive 1 (+): 18V OUT
  - b. Positive 2 (+): 5V OUT
  - c. Negative (-): GND
5. Turn Power Supply on after making connections.

## Contact Information

To request this evaluation board, please refer to your local sales offices which can be found from:

<http://www.monolithicpower.com/Company/Contact-Us>

## Disclaimer

Monolithic Power Systems (MPS) reserves the right to make changes to its products and to discontinue products without notice. The applications information, schematic diagrams, and other reference information included herein is provided as a design aid only and are therefore provided as-is. MPS makes no warranties with respect to this information and disclaims any implied warranties of merchantability or non-infringement of third-party intellectual property rights.

MPS cannot assume responsibility for use of any circuitry other than circuitry entirely embodied in a MPS product. No circuit patent licenses are implied.

Certain applications using semiconductor products may involve potential risks of death, personal injury, or severe property or environmental damage ("Critical Applications").

**MPS PRODUCTS ARE NOT DESIGNED, INTENDED, AUTHORIZED, OR WARRANTED TO BE SUITABLE FOR USE IN LIFE-SUPPORT APPLICATIONS, DEVICES OR SYSTEMS, OR OTHER CRITICAL APPLICATIONS.**

Inclusion of MPS products in critical applications is understood to be fully at the risk of the customer. Questions concerning potential risk applications should be directed to MPS.

MPS semiconductors are typically used in power supplies in which high voltages are present during operation. High voltage safety precautions should be observed in design and operation to minimize the chance of injury.

**NOTICE:** The information in this document is subject to change without notice. Please contact MPS for current specifications. Users should warrant and guarantee that third party Intellectual Property rights are not infringed upon when integrating MPS products into any application. MPS will not assume any legal responsibility for any said applications.