

DESCRIPTION

The EV4056-K-00A Evaluation Board is designed to demonstrate the capabilities of MP4056. The MP4056 is a non-isolated, TRIAC dimmable LED controller with active PFC and excellent dimming performance.

It works in boundary conduction mode for reducing the MOSFET and Diode switching losses. Its adaptive dimmer type detection and phase-cut-based dimming control can achieve good dimmer compatibility and deep dimming range.

The EV4056-K-00A is typically designed for driving a 16W TRIAC dimmable LED bulb with 48V_{TYP}, 340mA LED load from 198VAC to 265VAC, 50Hz.

The EV4056-K-00A has a cost effective BOM and excellent efficiency. It meets IEC61547 surge immunity, IEC61000-3-2 Class C harmonics and EN55015 conducted EMI requirements. It has multi-protection function as over-voltage protection; winding short circuit protection; output short-circuit protection; ZCD pin short protection; over-temperature protection etc.

ELECTRICAL SPECIFICATION

Parameter	Symbol	Value	Units
Input Voltage	V _{IN}	198 to 265	VAC
Output Voltage	V _{OUT}	48	V
LED Current	I _{LED}	340	mA
Output Power	P _{OUT}	16.32	W
Efficiency (full load)	η	>88	%
Power Factor	PF	>0.86	
THD	THD	<37	%

FEATURES

- Adaptive Dimmer Type Detection and Phase-Cut-Based Dimming Control
- Good Dimmer Compatibility
- Fast Start-Up without Perceptible Delay
- Accurate Line & Load Regulation
- High Power Factor
- High Efficiency
- Operates in Boundary Conduction Mode
- Cycle-by-Cycle Current Limit
- Winding Short-Circuit Protection
- Output Over-Voltage Protection
- Output Short-Circuit Protection
- ZCD Pin Short Protection
- Over-Temperature Protection

APPLICATIONS

- Solid State Lighting
- Industrial & Commercial Lighting
- Residential Lighting

All MPS parts are lead-free, halogen free, and adhere to the RoHS directive. For MPS green status, please visit MPS website under Quality Assurance.

"MPS" and "The Future of Analog IC Technology" are Registered Trademarks of Monolithic Power Systems, Inc.



Warning: Although this board is designed to satisfy safety requirements, the engineering prototype has not been agency approved. Therefore, all testing should be performed using an isolation transformer to provide the AC input to the prototype board.

EV4056-K-00A EVALUATION BOARD

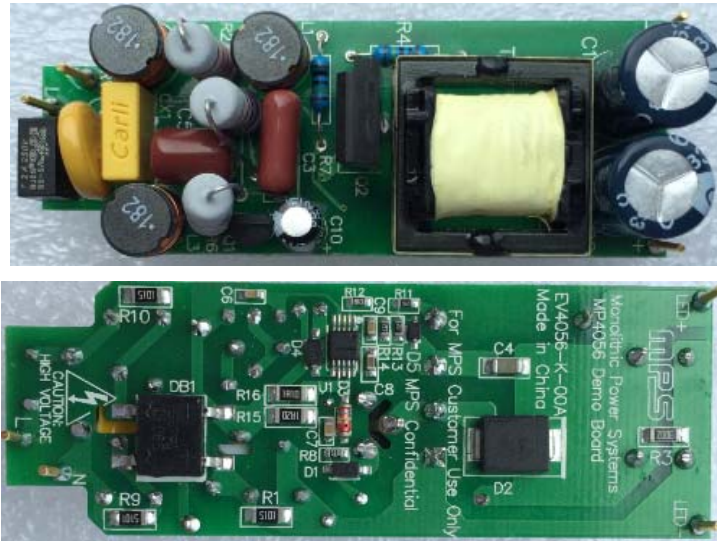

(L x W x H) 70.5mm x 26.5mm x 24mm

Board Number	MPS IC Number
EV4056-K-00A	MP4056GK

EVALUATION BOARD SCHEMATIC

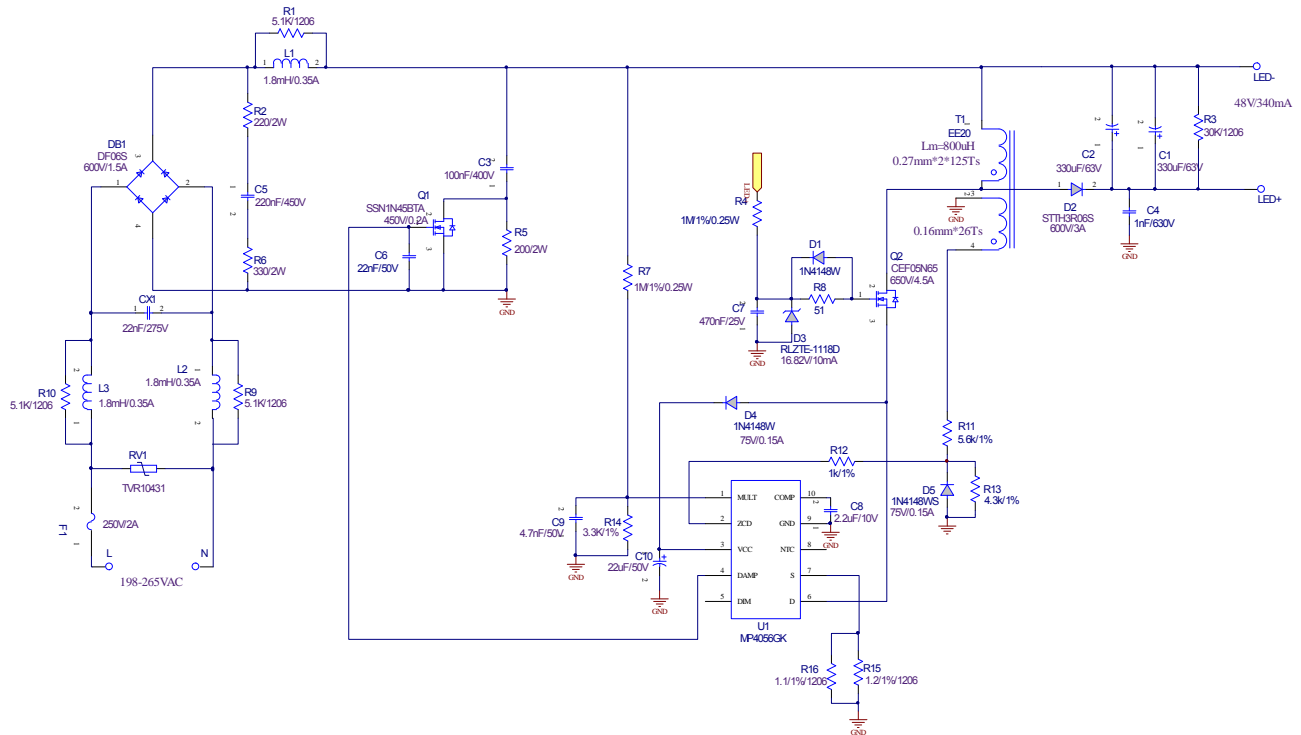

Figure 1—Schematic

PCB LAYOUT (SINGLE-SIDED)

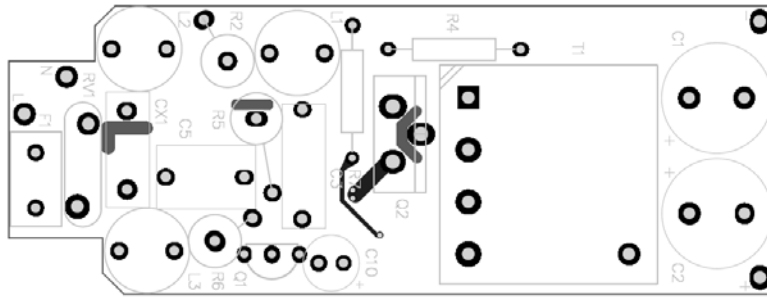

Figure 2—Top Layer

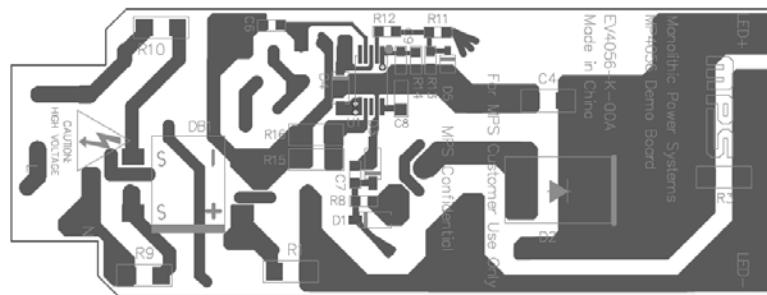

Figure 3—Bottom Layer

CIRCUIT DESCRIPTION

The EV4056-K-00A is configured in a single-stage Buck-boost topology and gets a cost effective BOM. It achieves high power factor and excellent TRIAC dimming performance.

F1, RV1, L2, L3, R9, R10, CX1 and DB1 compose the input stage. F1 fuses the AC input to protect for the component failure or some excessive short events. RV1 is used for surge test. The diode rectifier DB1 rectifies the input line voltage. L2, L3, R9, R10, CX1, L1, R1 and C3 form the input EMI filter. Small bulk CBB capacitor C3 is used for a low impedance path for the switching current.

C5, R2 and R6 are used as a passive bleeder which helps keep the TRIAC current above the minimum holding current after TRIAC turns on.

Q1, C6, R5 associate with the control signal DAMP compose the active damping circuit to limit the inrush current caused by C3 at leading edge dimmer turn on.

R7, R10, C9 provide sine wave reference for the current control loop.

D4 and C10 are used to supply the power for MP4056. A 22 μ F electrolytic capacitor C10 is selected to maintain the supply voltage. At start-up, C10 is charged up through Q1, D4 and the internal charging circuit, when the VCC voltage reaches VCC_{EN}, the internal charging circuit stops charging. Then the power supply is charged by Q1, D4 during the switching off time.

R4, C7, D1 and D3 are used for the gate driver of the external MOSFET Q1. R8 is used to adjust the driver capability for better EMI and small power loss.

R11, R13 are used to detect the auxiliary winding to get the transformer magnetizing current zero crossing signal for realizing the boundary conduction operation, and also monitor the output OVP condition. The OVP voltage is set by the divider ratio of R11, R13. R12 is used to limit the current flow into ZCD pin. D5 is used to clamp the negative voltage on ZCD Pin when switch on.

R15, R16 are sensing resistors for current control. The value of R5 and R16 set the output LED current.

Diode D2 is the output rectifying diode. The capacitors C1, C2 are the output filter. The resistor R3 is placed as a dummy load to consume the output power in open load condition. The capacitor C4 is used to help improve the high frequency EMI performance.

EV4056-K-00A BILL OF MATERIALS

Qty	Ref	Value	Description	Package	Manufacturer	Manufacturer_P/N
2	C1,C2	330uF/63V	Electrolytic Capacitor;63V	DIP	Jianghai	CD263-63V330
1	C3	100nF/400V	CBB;400V	DIP	Panasonic	ECQE4104KF
1	C4	1nF/630V	Ceramic Capacitor;630V;U2J	1206	muRata	GRM31A7U2J102JW31D
1	C5	220nF/450V	CBB;450V	DIP	Fala	C222S224K31C000
1	C6	22nF/50V	Ceramic Capacitor;50V;X7R	0603	muRata	GRM188R71H223KA01D
1	C7	470nF/25V	Ceramic Capacitor;25V;X7R	0603	TDK	GRM188R71E474KA12D
1	C8	2.2uF/10V	Ceramic Capacitor;10V;X7R	0603	muRata	GRM188R71A225KE15D
1	C9	4.7nF/50V	Ceramic Capacitor;50V;X7R	0603	TDK	GRM188R71H472KA01D
1	C10	22uF/50V	Electrolytic Capacitor;50V	DIP	Jianghai	CD281L-50V22
1	CX1	22nF/275V	X Capacitor;275V;10%	DIP	Carli	PX223K3IC39L270D9R
2	D1,D4	1N4148W	Diode;75V;0.15A;	SOD-123	Diodes	1N4148W-7-F
1	D2	STTH3R06S	Diode;600V;3A	SMC	ST	STTH3R06S
1	D3	RLZTE-1118D	Zener Diode;16.82V,10mA	MINIMEL F	ROHM	RLZTE-1118D
4	D5	1N4148WS	Diode;75V;0.15A;	SOD-323	Diodes	1N4148WS-7-F
1	DB1	DF06S	Diode;600V;1.5A	SMD	Fairchild	DF06S
1	F1	SS-5-2A	Fuse;250V;2A	DIP	COOPER BUSSMANN	SS-5-2A
3	L1,L2, L3	1.8mH/0.35A	Inductor;1.8mH; 3.3 Ohm;0.35A	DIP	Wurth	768772182
1	Q1	SSN1N45BTA	N-Channel Mosfet;450V	TO-92	Fairchild	SSN1N45BTA
1	Q2	CEF05N65	Mosfet;650V;4.5A	TO-220F	MAXMEGA	CEF05N65
3	R1,R9, R10	5.1kΩ	Film Resistor;1%	1206	Yageo	RC1206FR-075K1L
2	R2	220Ω/2W	Resistor;5%;2W	DIP	any	510 Ohm/2W
1	R3	30kΩ	Film Resistor;1%	1206	Yageo	RC1206FR-0730KL
2	R4,R7	1MΩ/0.25W	Resistor;1%;1/4W	DIP	any	1MΩ
2	R5	200Ω/2W	Resistor;5%;2W	DIP	any	200Ω/2W
2	R6	330Ω/2W	Resistor;5%;2W	DIP	any	330Ω/2W
1	R8	51Ω	Film Resistor;1%;	0603	Yageo	RC0603FR-0751RL
1	R11	5.6kΩ	Film Resistor;1%	0603	Yageo	RC0603FR-075K6L
1	R12	1kΩ	Film Resistor;1%;	0603	Yageo	RC0603FR-071KL
1	R13	4.3kΩ	Film Resistor;1%	0603	Yageo	RC0603FR-074K3L
1	R14	3.3kΩ	Film Resistor;1%	0603	Yageo	RC0603FR-073K3L
1	R15	1.2Ω	Film Resistor;1%	1206	Yageo	RC1206FR-071R2L
1	R16	1.1Ω	Film Resistor;1%	1206	Yageo	RC1206FR-071R1L

EV4056-K-00A BILL OF MATERIALS *(continued)*

Qty	Ref	Value	Description	Package	Manufacturer	Manufacturer_P/N
1	RV1	TVR10431	MOV	DIP	TSK	TVR10431KSY
1	T1	EF20	L=800uH; Np:Naux=125:26	DIP	Emei	FX0408
1	U1	MP4056	TRAIC Dimmable, Offline LED Lighting Controller	MSOP10	MPS	MP4056GK-LF-Z R3

TRANSFORMER SPECIFICATION

Electrical Diagram

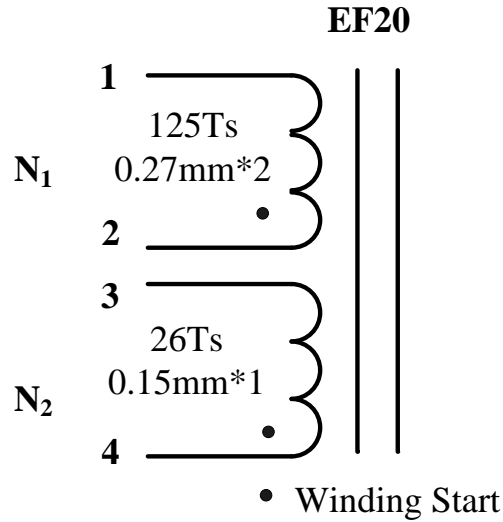

Figure 4—Transformer Electrical Diagram

Winding Diagram

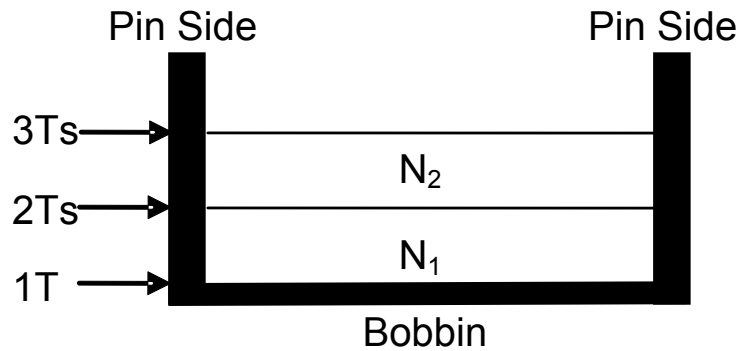

Figure 5—Winding Diagram

Winding Order

Winding No.	Tape Layer Number	Start & End	Magnet Wire Φ (mm)	Turns
	1			
N ₁	2	2→1	0.27mm * 2	125
N ₂	3	4→3	0.15mm*1	26

Electrical Specifications

Electrical Strength	60 second, 50Hz, from Windings to CORE.	1000VAC
Inductance	Pins 2 - 1, all other windings open, measured at 50kHz, 0.1 VRMS	800uH±5%

Materials

Item	Description
1	Core: EF20, UI=2500±25%, ACME P4 or equivalent
2	Bobbin: EF20, 4+4PIN, REMOVE PIN6,7
3	Wire: Φ 0.27mm, Φ 0.15mm, 2UEW, CLASS F or equivalent
4	Tape: 6.5mm(W)×0.06mm(TH)
5	Varnish: JOHN C. DOLPH CO, BC-346A or equivalent
6	Solder Bar: CHEN NAN: SN99.5/Cu0.5 or equivalent

EVB TEST RESULTS

Performance Data

Efficiency, PF and THD

f (Hz)	Vin(V)	Pin(W)	Vo(V)	Io(mA)	Po(W)	Efficiency(%)	PF	THD(%)
50	198	18.44	47.00	346	16.26	88.19	0.910	37.00
	210	18.47	47.00	347	16.31	88.30	0.905	36.70
	220	18.48	47.00	347	16.31	88.25	0.900	36.40
	230	18.51	47.00	347	16.31	88.11	0.894	35.70
	240	18.53	47.00	348	16.36	88.27	0.887	35.30
	250	18.57	47.00	348	16.36	88.08	0.880	34.80
	260	18.61	47.00	349	16.40	88.14	0.872	34.30
	265	18.62	47.00	349	16.40	88.09	0.868	34.10

Dimming Compatibility (No flicker with these 26 different Dimmers)

Dimmer No.	Manufacturer	Part No.	Power Stage	Dimming Type	I _{max} (mA)	I _{min} (mA)
1	MIKA	433/4	60-400W	Leading	349.1	67
2	Busch	2250U	600W	Leading	349.2	33
3	Berker	283010	60-400W	Leading	348.6	43.1
4	JUNG	225 NV DE	20-500W/VA	Leading	348.7	26.7
5	Berker	286610	20-500W	Leading	349	39.8
6	EMC	PROP400U	40-400W	Leading	347.7	37.6
7	Busch	2247U	500W/VA	Leading	348.4	43.9
8	Busch	2200..	60-400W	Leading	348.1	49.6
9	JUNG	225 NV DE	20-500W/VA	Leading	349.4	43.7
10	JUNG	266 GDE	60-600W	Leading	348.9	36.2
11	Berker	2875	60-600W	Leading	348.9	31.7
12	Berker	2819	60-400W	Leading	348.4	75
13	MIKA	433	60-300	Leading	348.1	70
14	GIRA	0300 00/I01	60-400W	Leading	347.9	68
15	TELLER	40600RL	40-600W	Leading	347.7	37.6
16	LICHTREGLER	T46s	20~315W	Trailing	355	298
17	Busch	6513 U-102	420W/VA	Trailing	356.2	26.4
18	MIKA	433 HAB	20-315W	Trailing	356.1	23.7

19	MIKA	EIM-585	20-300W	Trailing	267.2	1.3
20	Busch	6519U	550W/VA	Trailing	355.6	25.8
21	JUNG	225 TDE	20-525W	Trailing	354.7	21.9
22	SIEMENS	5TC8 284	20-600W	Trailing	355.1	21.3
23	JUNG	254 UDIE 1	50-420W/VA	Trailing	342.3	37
24	Berker	286110	50-420W	Trailing	353.9	37.5
25	MIKA	433HAB	20-315W	Trailing	333.1	25.5
26	LUMEO ECO	T46.03	15-150W	Trailing	354.5	31.8

Electric Strength Test

Input and output was shorted respectively. 3750VAC/50Hz sine wave applied between input and output for 1min, and operation was verified.

Surge Test

Line to Line 500V surge testing was completed according to IEC61547.

Input voltage was set at 230VAC/50Hz. Output was loaded at full load and operation was verified following each surge event.

Surge Level (V)	Input Voltage (VAC)	Injection Location	Injection Phase (°)	Test Result (Pass/Fail)
500	230	L to N	90	Pass
-500	230	L to N	270	Pass

Thermal Test (worst case with/without dimmer)

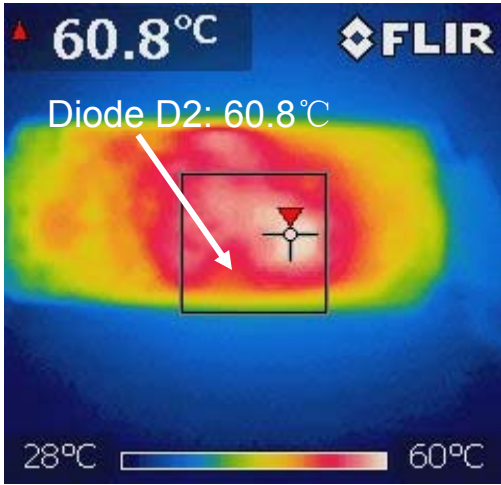

Without dimmer

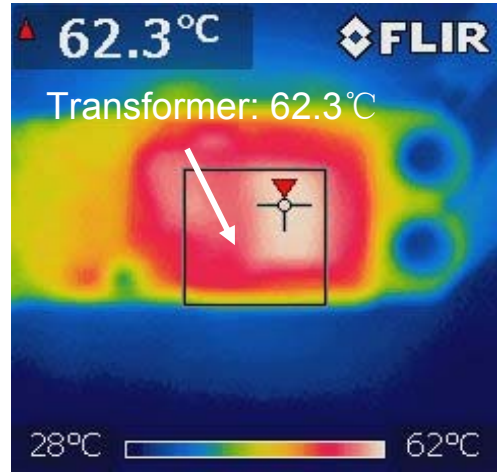

Without dimmer

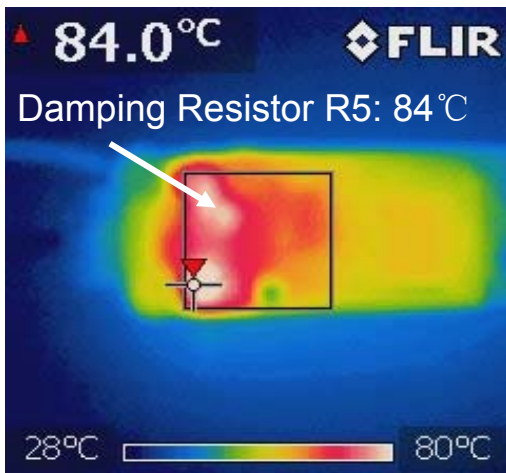

Leading edge dimmer with 50% turn on cycle

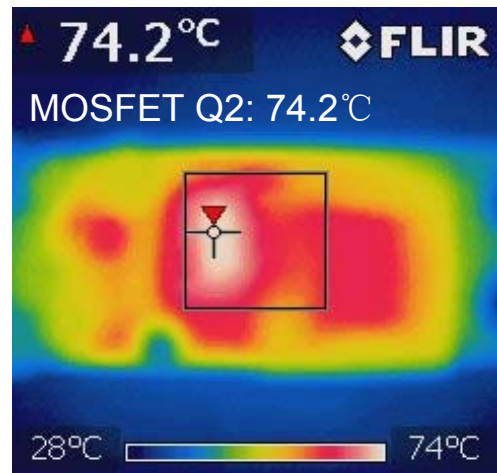

Trailing edge dimmer with 90% turn on phase

EVB TEST RESULTS

Performance waveforms are tested on the evaluation board.

$V_{IN}=230V_{AC}/50Hz$, 15LEDs in series, $I_{LED}=340mA$, $V_{OUT}=48V$.

Line Regulation

$V_{IN}=(198-265)V_{AC}/50Hz$, Full Load

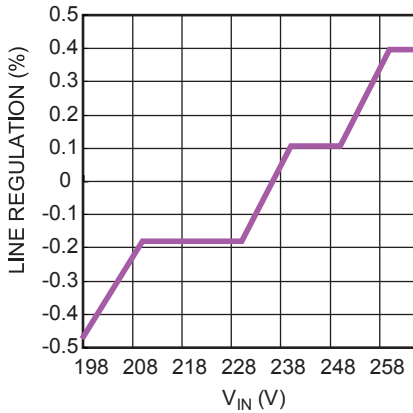

Efficiency vs. V_{IN}

$V_{IN}=(198-265)V_{AC}/50Hz$, Full Load

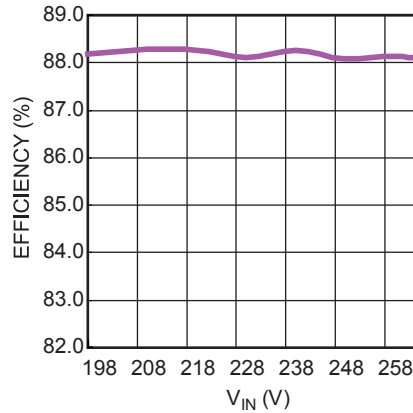

PF vs. V_{IN}

$V_{IN}=(198-265)V_{AC}/50Hz$, Full Load

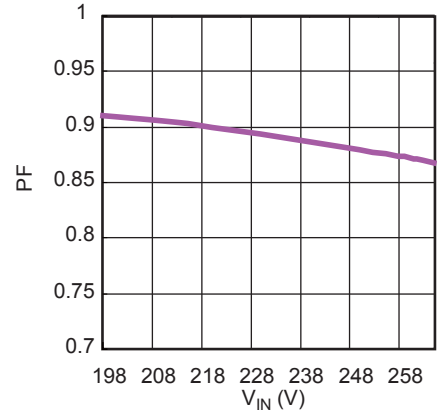

THD vs. V_{IN}

$V_{IN}=(198-265)V_{AC}/50Hz$, Full Load

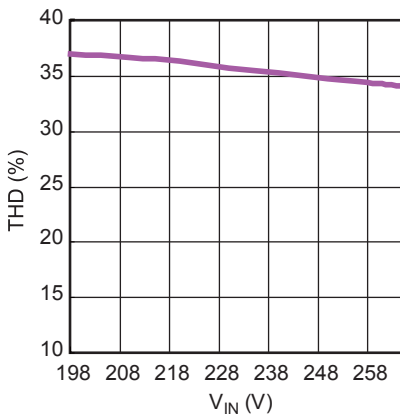

Dimming Curve

$V_{IN}=230V_{AC}/50Hz$, Full Load, with Different Dimmers

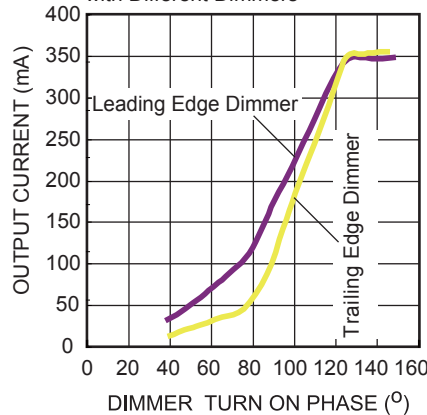

Conducted EMI, L-Line

$V_{IN}=230V_{AC}/50Hz$, RBW=9kHz, MT=20ms

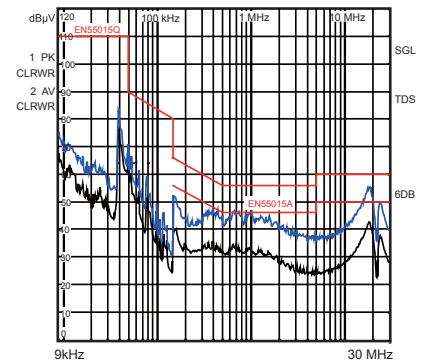

Conducted EMI, N-Line

$V_{IN}=230V_{AC}/50Hz$, RBW=9kHz, MT=20ms

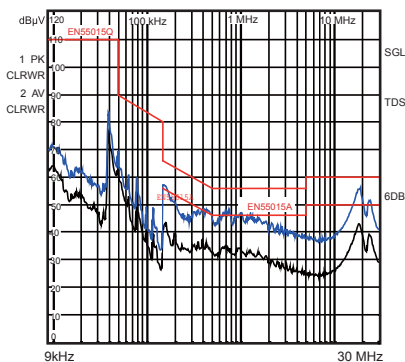

CDN Test

$V_{IN}=230V_{AC}/50Hz$, RBW=120kHz, MT=1ms

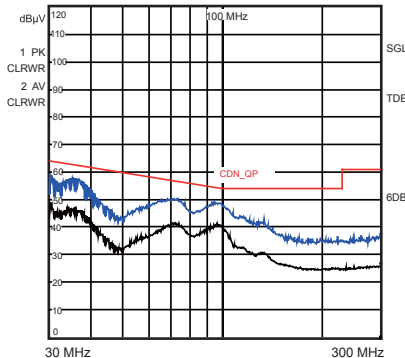

EVB TEST RESULTS (continued)

Performance waveforms are tested on the evaluation board.

 $V_{IN}=230V_{AC}/50Hz$, 15LEDs in series, $I_{LED}=340mA$, $V_{OUT}=48V$.

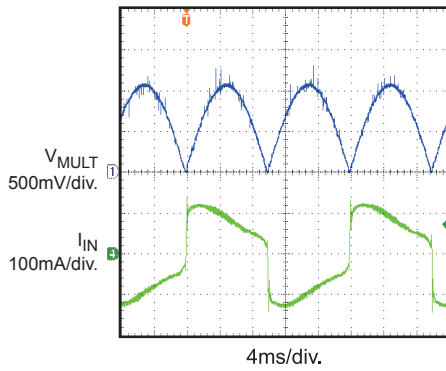
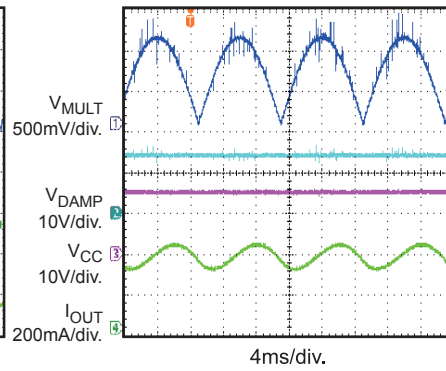
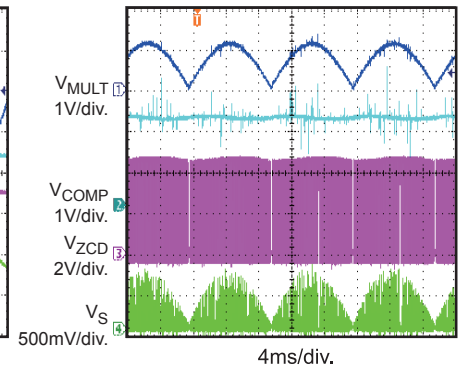
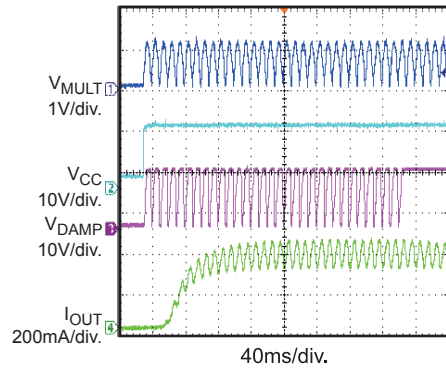
Steady State
 $V_{IN}=230V_{AC}/50Hz$, Full Load

Steady State
 $V_{IN}=230V_{AC}/50Hz$, Full Load

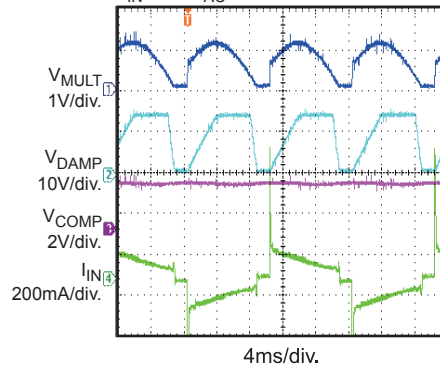
Steady State
 $V_{IN}=230V_{AC}/50Hz$, Full Load

 V_{IN} Start-Up
 $V_{IN}=230V_{AC}/50Hz$, Full Load

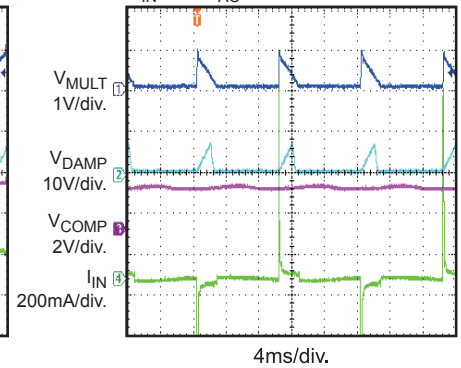
Dimming Performance

Max Dimming on Phase with Leading-Edge Dimmer

 $V_{IN}=230V_{AC}/50Hz$

Dimming Performance

Min Dimming on Phase with Leading-Edge Dimmer

 $V_{IN}=230V_{AC}/50Hz$

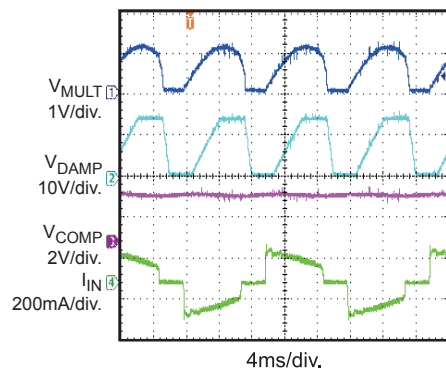
Dimming Performance

Max Dimming on Phase with Trailing-Edge Dimmer

 $V_{IN}=230V_{AC}/50Hz$

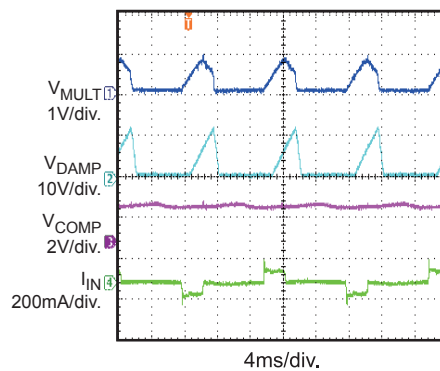
Dimming Performance

Min Dimming on Phase with Trailing-Edge Dimmer

 $V_{IN}=230V_{AC}/50Hz$

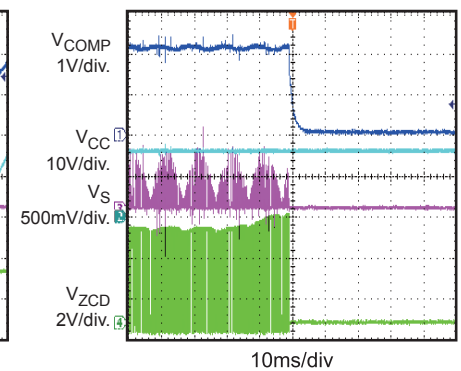
OVP

LED Load Open

 $V_{IN}=230V_{AC}/50Hz$, Full Load

EVB TEST RESULTS (continued)

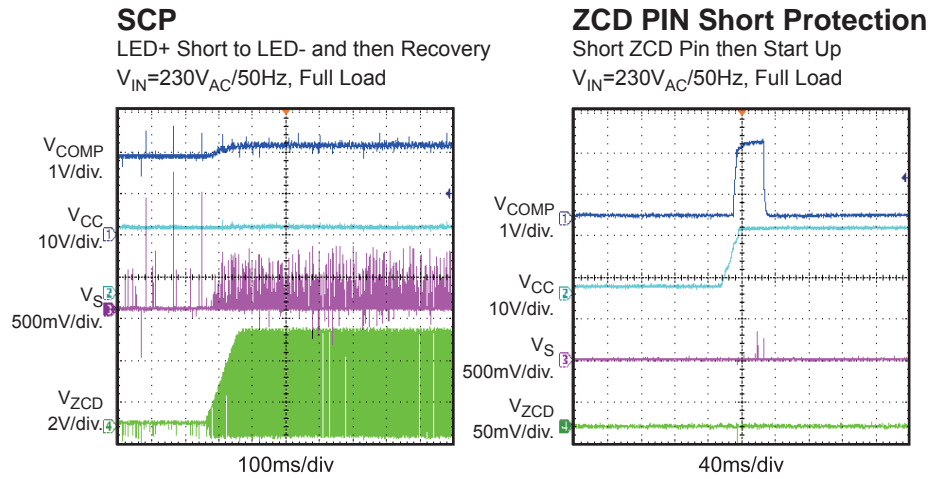
Performance waveforms are tested on the evaluation board.

 $V_{IN}=230V_{AC}/50Hz$, 15LEDs in series, $I_{LED}=340mA$, $V_{OUT}=48V$.

QUICK START GUIDE

1. Preset AC Power Supply to $198\text{VAC} \leq V_{\text{IN}} \leq 265\text{VAC}$.
2. Turn Power Supply off.
3. Connect the LED string between “LED+” (anode of LED string) and “LED-” (cathode of LED string).
4. Connect Power Supply terminals to AC V_{IN} terminals (“L” and “N”) as shown on the board.
5. Turn AC Power Supply on after making connections.

NOTICE: The information in this document is subject to change without notice. Users should warrant and guarantee that third party Intellectual Property rights are not infringed upon when integrating MPS products into any application. MPS will not assume any legal responsibility for any said applications.